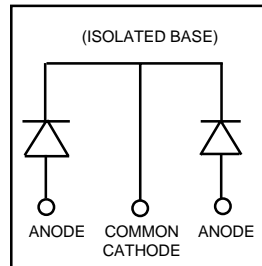


## Features

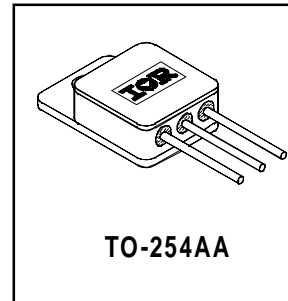
- Reduced RFI and EMI
- Reduced Snubbing
- Extensive Characterization of Recovery Parameters
- Hermetic
- Electrically Isolated
- Ceramic Eyelets



$V_R = 1200V$
$V_F = 4.46V$
$Q_{rr} = 370nC$
$di_{(rec)}/dt = 380A/\mu s$

## Description

HEXFRED™ diodes are optimized to reduce losses and EMI/RFI in high frequency power conditioning systems. An extensive characterization of the recovery behavior for different values of current, temperature and di/dt simplifies the calculations of losses in the operating conditions. The softness of the recovery eliminates the need for a snubber in most applications. These devices are ideally suited for power converters, motors drives and other applications where switching losses are significant portion of the total losses.



## Absolute Maximum Ratings (per Leg)

	Parameter	Max.	Units
$V_R$	D.C. Reverse Voltage	1200	V
$I_F @ T_C = 100^\circ C$	Continuous Forward Current ①	15	A
$I_{FSM} @ T_C = 25^\circ C$	Single Pulse Forward Current ②	130	
$P_D @ T_C = 25^\circ C$	Maximum Power Dissipation	63	W
$T_J$	Operating Junction and	-55 to +150	°C
$T_{STG}$	Storage Temperature Range		

## Thermal - Mechanical Characteristics

	Parameter	Typ.	Max.	Units
$R_{\theta JC}$	Junction-to-Case, Single Leg Conducting	—	2.0	°C/W
	Weight	9.3	—	g

**Note:** ① D.C. = 50% rect. wave  
 ② 1/2 sine wave, 60 Hz, P.W. = 8.33 ms

# HFA35HB120C

International  
**IRF** Rectifier

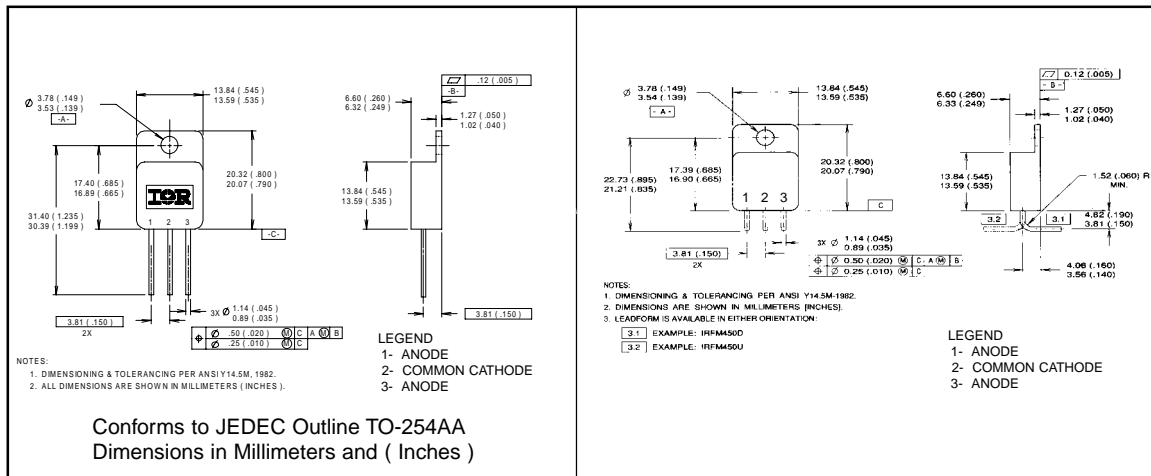
## Electrical Characteristics (per Leg) @ T<sub>J</sub> = 25°C (unless otherwise specified)

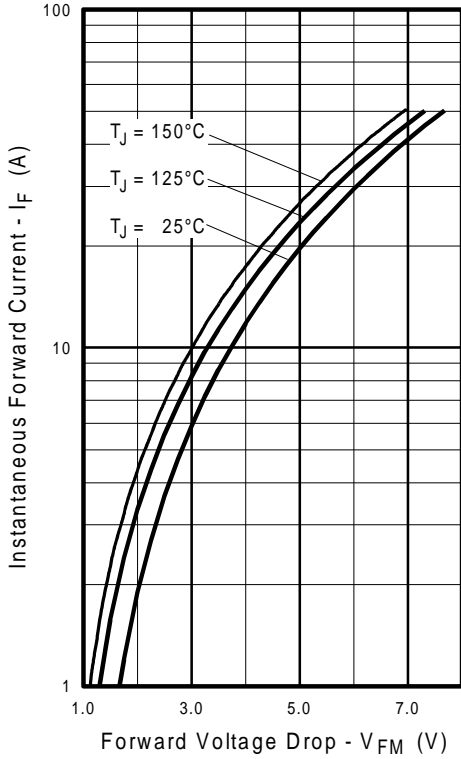
	Parameter	Min.	Typ.	Max.	Units	Test Conditions
V <sub>BR</sub>	Cathode Anode Breakdown Voltage	1200	—	—	V	I <sub>R</sub> = 250μA
V <sub>FM</sub>	Max Forward Voltage	—	—	3.3	V	I <sub>F</sub> = 7.0A
		—	—	4.4		I <sub>F</sub> = 15A See Fig. 1
		—	—	2.8		I <sub>F</sub> = 7.0A, T <sub>J</sub> = 125°C
I <sub>RM</sub>	Max Reverse Leakage Current	—	—	10	μA	V <sub>R</sub> = V <sub>R</sub> Rated See Fig. 2
		—	—	1.0	mA	T <sub>J</sub> = 125°C, V <sub>R</sub> = 480V
C <sub>T</sub>	Junction Capacitance	—	10	15	pF	V <sub>R</sub> = 200V See Fig. 3
L <sub>S</sub>	Series Inductance	—	8.7	—	nH	Measured from center of bond pad to end of anode bonding wire

## Dynamic Recovery Characteristics (per Leg) @ T<sub>J</sub> = 25°C (unless otherwise specified)

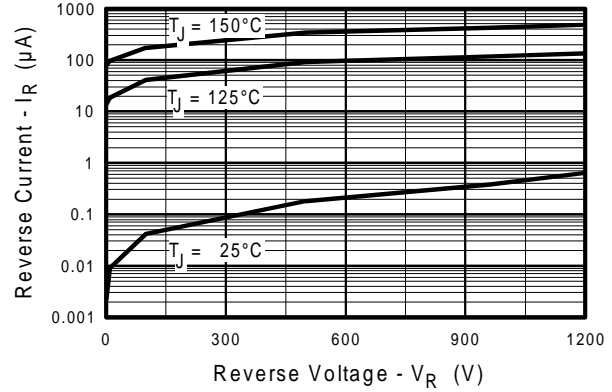
	Parameter	Min.	Typ.	Max.	Units	Test Conditions
t <sub>rr1</sub>	Reverse Recovery Time	—	58	100	ns	T <sub>J</sub> = 25°C See Fig.
t <sub>rr2</sub>		T <sub>J</sub> = 125°C 5				
I <sub>RRM1</sub>	Peak Recovery Current	—	5.4	8.1	A	T <sub>J</sub> = 25°C See Fig.
I <sub>RRM2</sub>		T <sub>J</sub> = 125°C 6				
Q <sub>rr1</sub>	Reverse Recovery Charge	—	185	370	nC	T <sub>J</sub> = 25°C See Fig.
Q <sub>rr2</sub>		T <sub>J</sub> = 125°C 7				
di <sub>(rec)</sub> M/dt1	Peak Rate of Fall of Recovery Current	—	255	380	A/μs	T <sub>J</sub> = 25°C See Fig.
di <sub>(rec)</sub> M/dt2		During t <sub>b</sub>	—	160		240

## Case Outline and Dimensions — TO-254AA

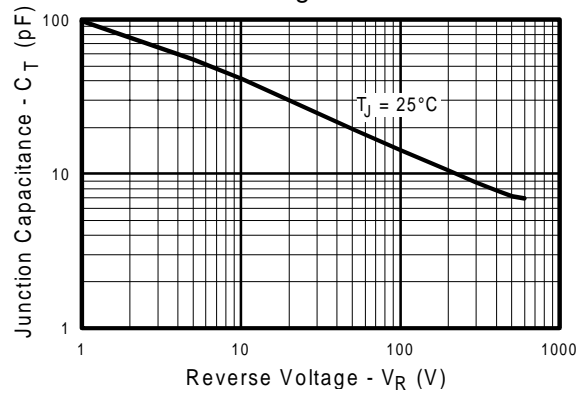




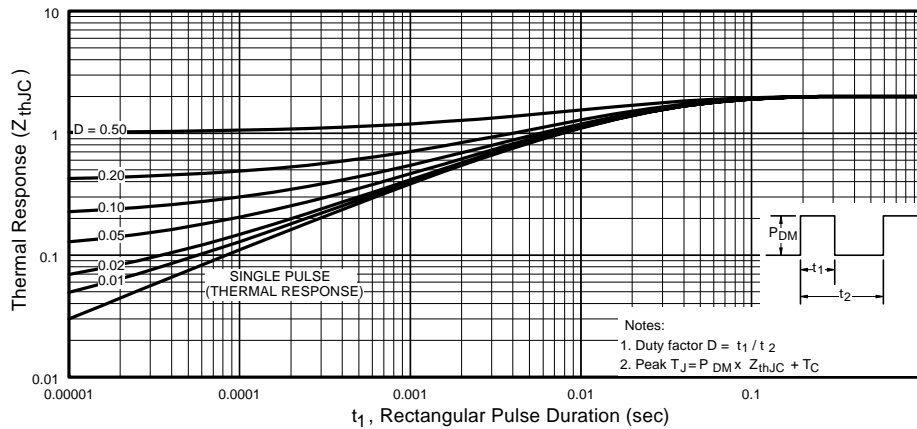
**Fig. 1** - Maximum Forward Voltage Drop vs. Instantaneous Forward Current



**Fig. 2** - Typical Reverse Current vs. Reverse Voltage



**Fig. 3** - Typical Junction Capacitance vs. Reverse Voltage



**Fig. 4** - Maximum Thermal Impedance  $Z_{thjC}$  Characteristics

# HFA35HB120C

International  
**IRF** Rectifier

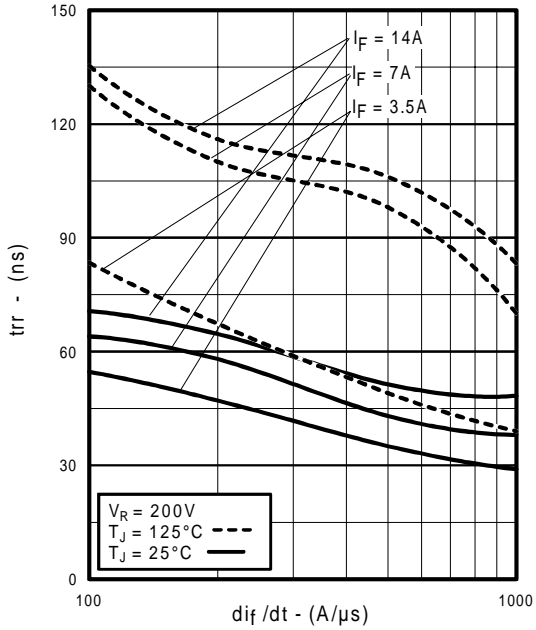


Fig. 5 - Typical Reverse Recovery vs.  $di_f/dt$

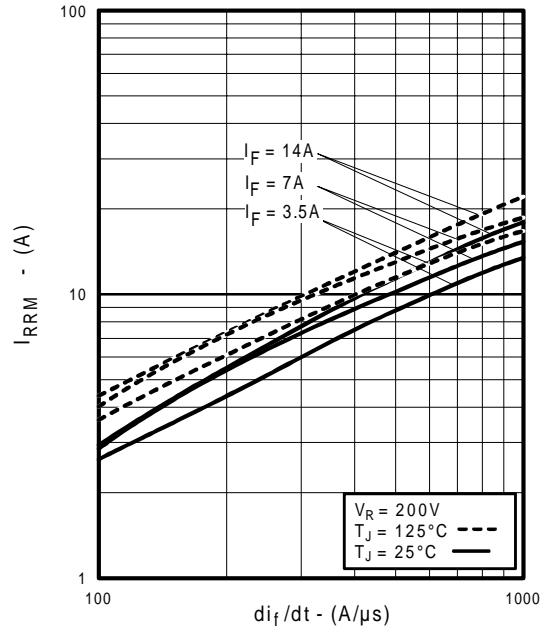


Fig. 6 - Typical Recovery Current vs.  $di_f/dt$

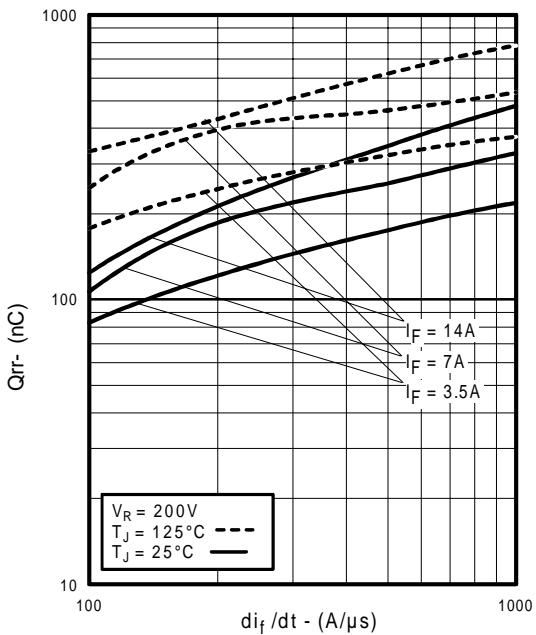


Fig. 7 - Typical Stored Charge vs.  $di_f/dt$

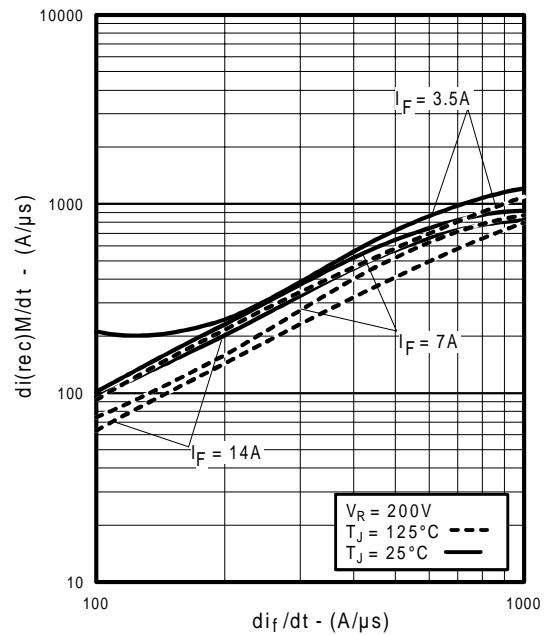
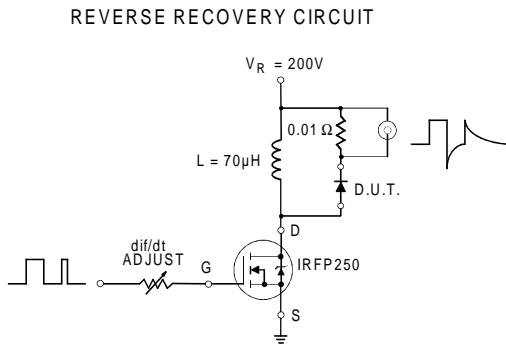
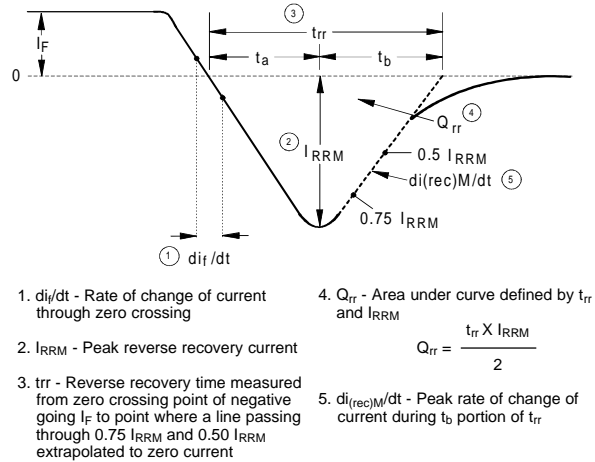


Fig. 8 - Typical  $di_{(rec)M}/dt$  vs.  $di_f/dt$



**Fig. 9 - Reverse Recovery Parameter Test Circuit**



**Fig. 10 - Reverse Recovery Waveform and Definitions**