

JRC SAW FILTER

NSVS680

Application

European keyless

Electrical Specification: (Table 1)

The device characteristics are measured in the circuit shown in Fig.1.

Table 1. Electrical Specifications

Item	Spec.	
Input and Output Impedance	50Ω	
Nominal Center Frequency (f0)	447 MHz	
Insertion Loss	446~448MHz	3.0dB max.
Response Variation	446~448MHz	1.5dB max.
Input and Output VSWR	446~448MHz	2.5 max.
Out of Band Rejection (Relative to Through Level)	425.3MHz	45dB min.

(Operating Temperature Range: -20~+70°C)

Maximum Rating: (Table 2)

Table 2. Maximum Ratings

Item	Rating
Maximum Input Power	+20dBm
Maximum DC Voltage	7.5V
Operating Temperature Range	-20~+70°C
Storage Temperature	-30~+80°C

Mechanical Specifications: (Fig.2)

Package is designed as small as 3.5x3.5x1.0[mm³] for SMD (Surface Mount Device) type.

Notice:

This part is electrostatic discharge sensitive and may be damaged by improper handling.

Communications and Device Group
Communications Equipment Marketing Department

Japan Radio Co., Ltd.

10-1, Nishi-Shinjuku 6-chome, Shinjuku-ku,

Tokyo, 160-8328 Japan

Tel. +81 3-3348-3845

Fax. +81 3-3348-3935

<http://www.jrc.co.jp/jp/product/device/saw/index.html> (Japanese)

http://www.jrc.co.jp/eng/product/comm/device/saw/saw_top_e.html (English)

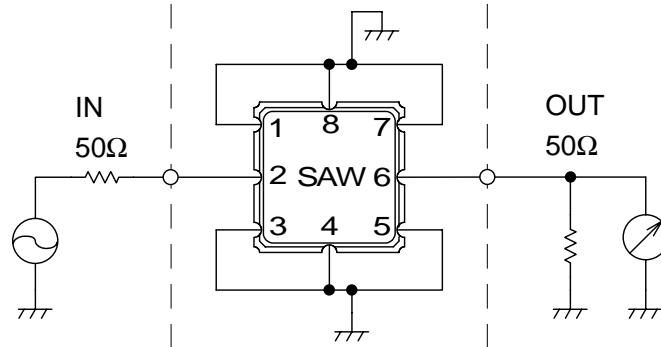
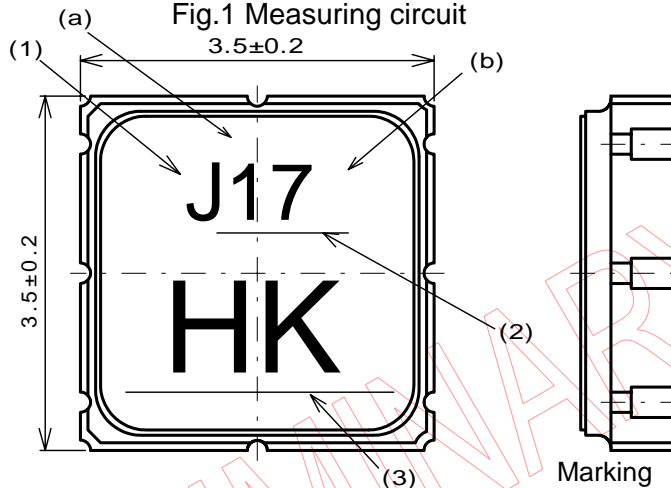

Fig.1 Measuring circuit



Marking

- (1) Manufacture's Mark
- (2) Lot Number
- (a) Year
- (b) Month

*Oct.--- X
 Nov.--- Y
 Dec.--- Z

- (3) Part number Mark

Pin no.	Connection
1	GND
2	IN/OUT
3	GND
4	GND
5	GND
6	OUT/IN
7	GND
8	GND

Fig.2 Package dimensions (in mm)

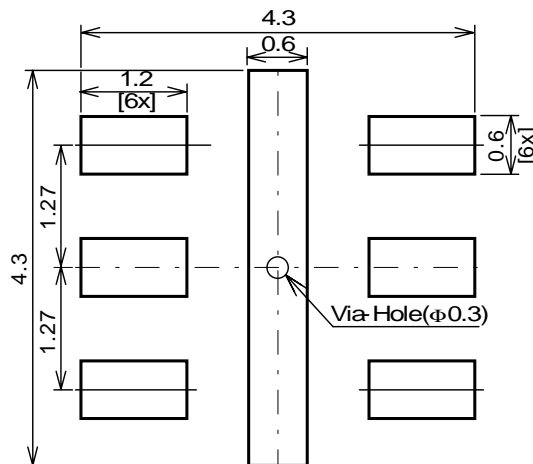

Fig.3 Desirable land area (in mm)

Notice

1. Use this component within operating temperature range. It might not be satisfied with electrical specification without operating temperature range. When it is used less than -20°C or more than $+70^{\circ}\text{C}$, it might be a cause of degradation or destruction of the component. Even if it endures during a short time, it causes degradation of qualification.
2. When soldering iron is used, solder with the temperature at the tip of soldering iron: 350°C max., the time of soldering: 10 seconds max., the power of soldering iron: 30W max..
3. Notice that the allowed time of soldering with soldering iron is accumulated time, when soldering is repeated.
4. As rapid temperature change for cleaning after reflow soldering might be a cause of destruction clean this component after confirming that temperature of this component goes down to room temperature.
5. Confirm that there are not any influence for qualification to this component in mounting on PCB when this component is cleaned.
6. As it might be a cause of degradation or destruction to apply static electricity to this component, do not apply static electricity or excessive voltage while assembling and measuring. And do not transport this component with bare hand.
7. As it might be a cause of degradation or destruction to apply D.C. voltage between each terminal, apply D.C. voltage 7.5V max. in actual circuit.

Note

1. This specification specifies the quality of this component as a single unit. Make sure that this component is evaluated and confirmed against this specification when it is mounted to your products.

12 May 2000 11:14:40

CH1 S₂₁ log MAG 1 dB/ REF 0 dB 1: -1.3276 dB
 CH2 S₂₁ log MAG 10 dB/ REF 0 dB

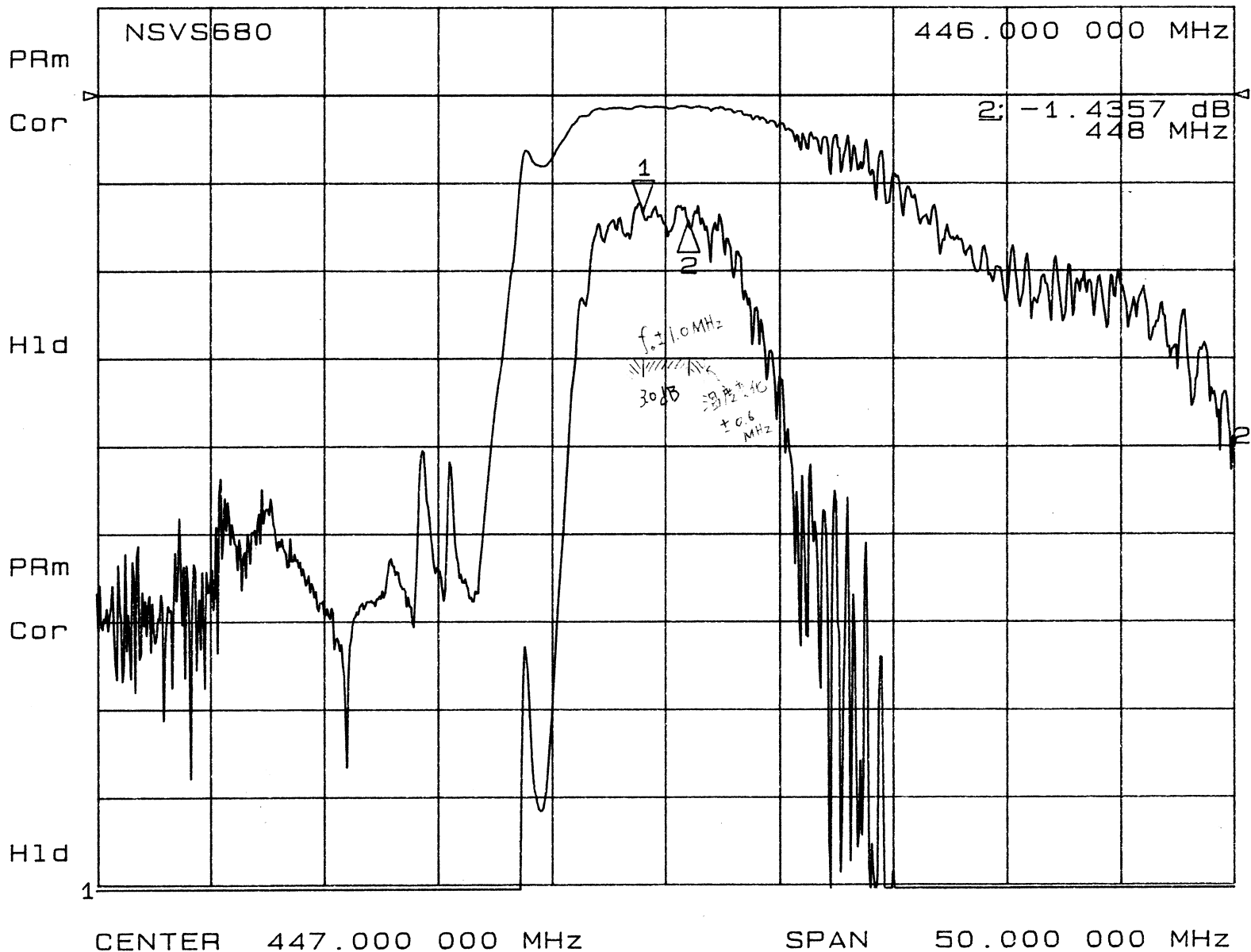

NSVS680
 447MHz SAWfilter
 特性図
 pass band

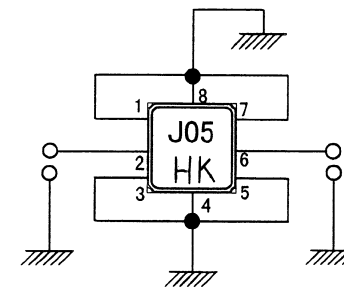

3.5mm□PKG
 2, 6 - IN/OUT
 1, 3, 4, 5, 7, 8 - GROUND

Japan Radio Co., Ltd.

12 May 2000 11:09:31

CH1 S₂₁ log MAG 1 dB/ REF 0 dB 1 -1.3187 dB
 CH2 S₂₁ log MAG 10 dB/ REF 0 dB

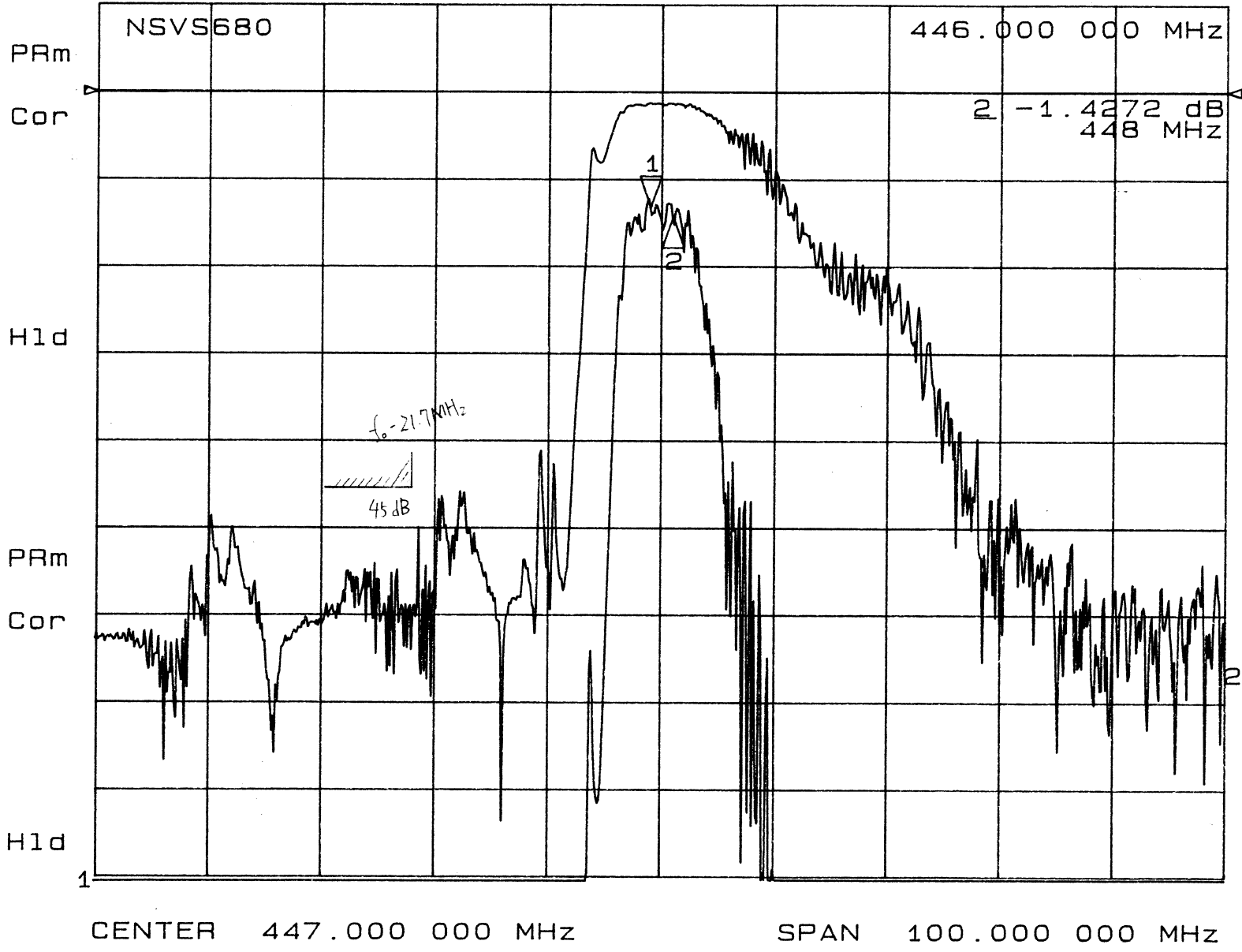

NSVS680
 447MHz SAWfilter
 特性図
 pass band

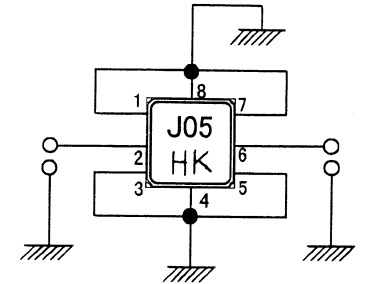

3.5mm□PKG
 2, 6 - IN/OUT
 1, 3, 4, 5, 7, 8 - GROUND

Japan Radio Co., Ltd.

12 May 2000 14:19:37
 CH1 S₁₁ 1 U FS 1: 46.555 n 6.8953 n 2.3892 nH
 NSVS680 446.000 000 MHz

PRm
 Cor

H1d

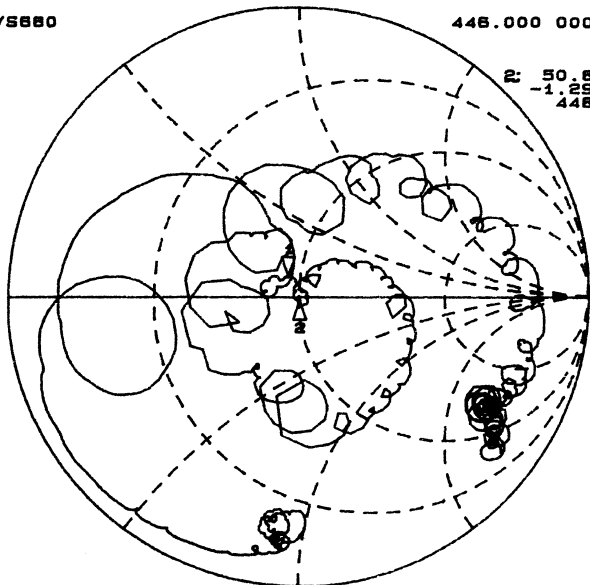

CENTER 447.000 000 MHz SPAN 50.000 000 MHz

12 May 2000 11:25:53
 CH2 S₂₂ 1 U FS 1: 44.867 n 6.2129 n 2.2171 nH
 446.000 000 MHz

PRm
 Cor

H1d

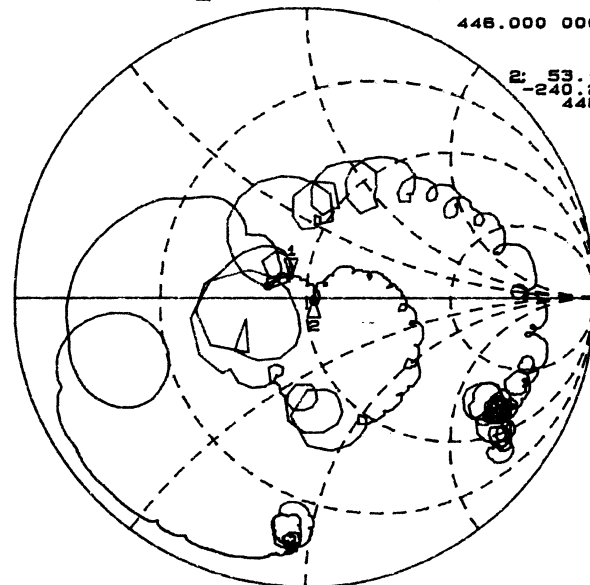

CENTER 447.000 000 MHz SPAN 50.000 000 MHz

NSVS680
 447MHz SAWfilter
 特性図
 smith-chart
 VSWR

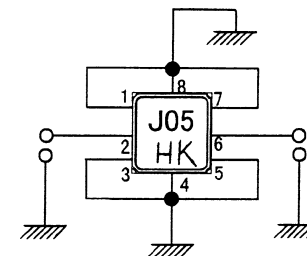

12 May 2000 11:23:01
 CH1 S₁₁ SWR 1 / REF 1 1: 1.1888
 NSVS680 446.000 000 MHz

PRm
 Cor

H1d

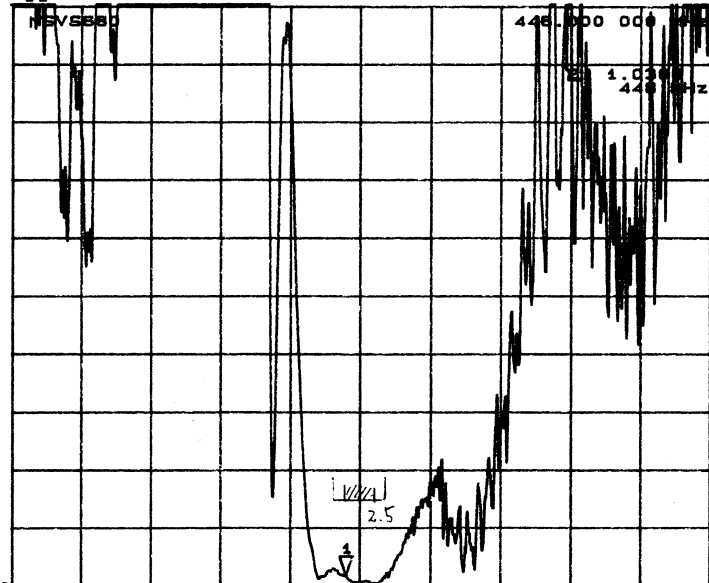

CENTER 447.000 000 MHz SPAN 50.000 000 MHz

12 May 2000 11:23:17
 CH2 S₂₂ SWR 1 / REF 1 1: 1.1852
 446.000 000 MHz

PRm
 Cor

H1d

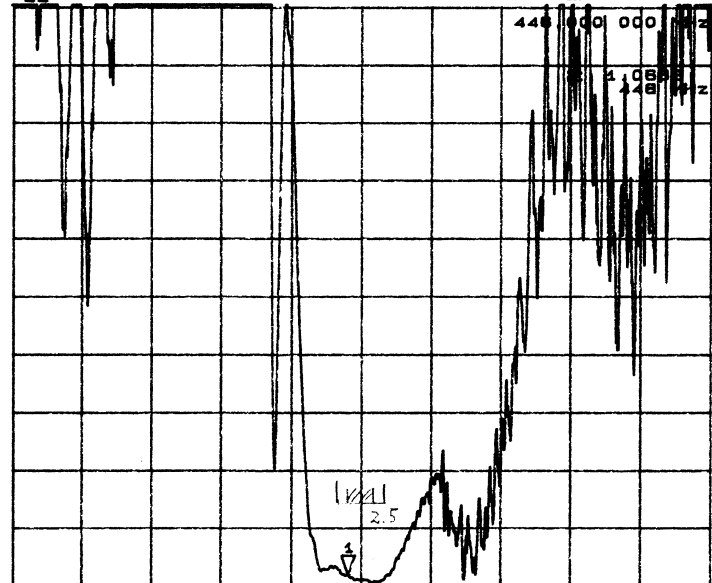

CENTER 447.000 000 MHz SPAN 50.000 000 MHz

Japan Radio Co., Ltd.

12 May 2000 11:32:27

CH1 S₂₁ log MAG 10 dB/ REF 0 dB

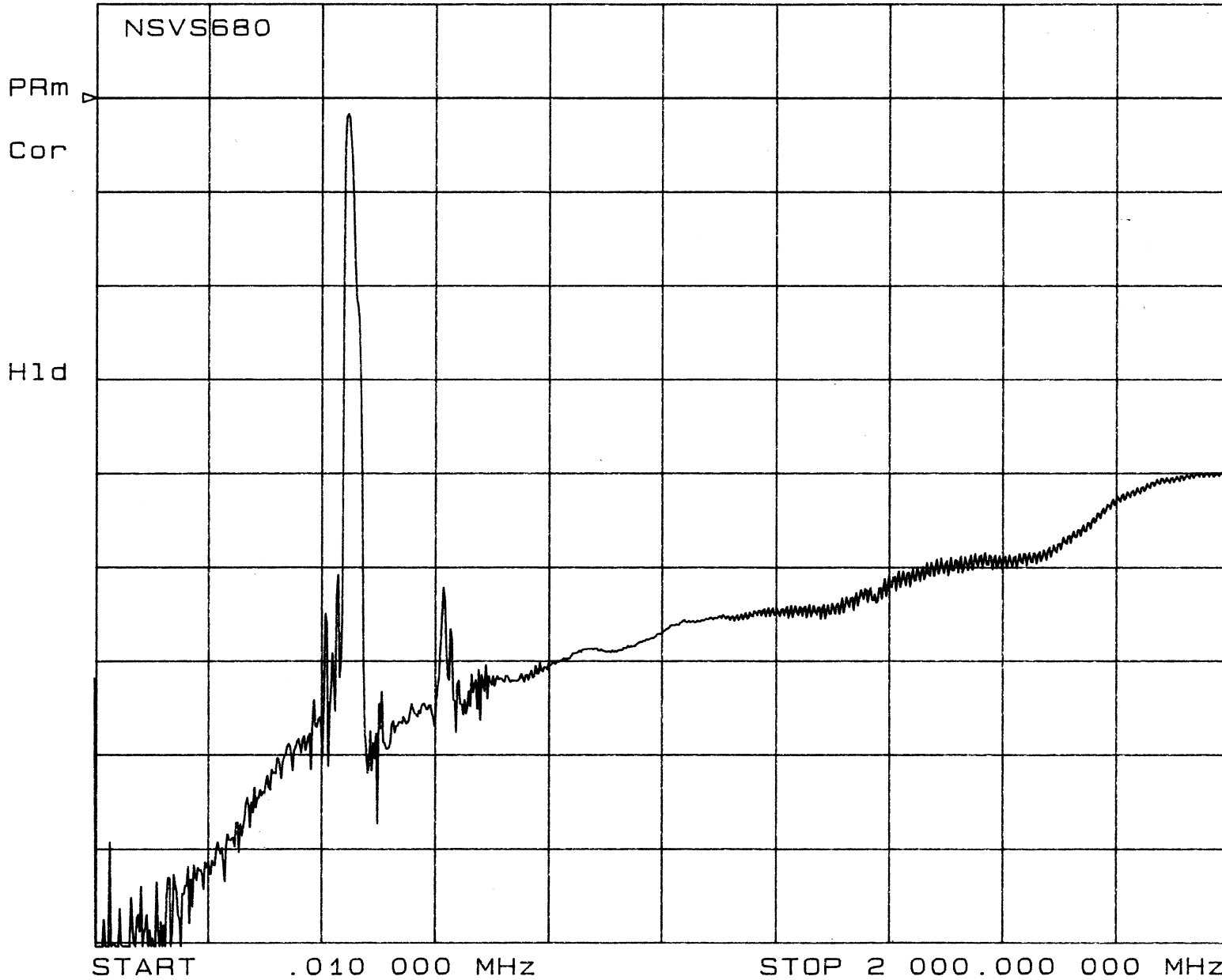

NSVS680
447MHz SAWfilter
特性図
100kHz~2.0GHz

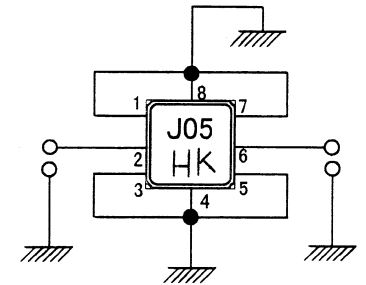

Japan Radio Co., Ltd.