

QSE213/QSE214 Plastic Silicon Infrared Phototransistor

Features

- NPN Silicon Phototransistor
- Package Type: Sidelooker
- Medium Reception Angle, 50°
- Daylight Filter
- Black Epoxy Package
- Matching Emitter: QEE213

Description

The QSE213/QSE214 is a silicon phototransistor encapsulated in a medium angle, infrared transparent, black thin plastic side-looker package.

Package Dimensions

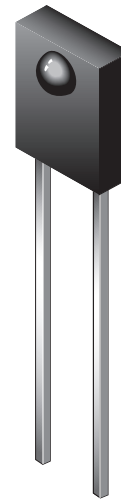
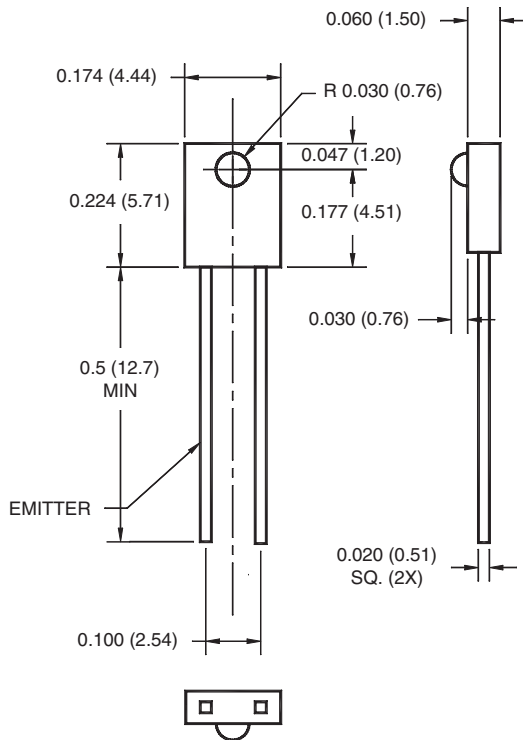

Schematic

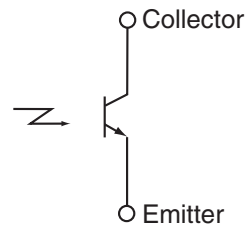

NOTES:

1. Dimensions for all drawings are in inches (mm).
2. Tolerance of $\pm .010$ (.25) on all non-nominal dimensions unless otherwise specified.

Absolute Maximum Ratings ($T_A = 25^\circ\text{C}$ unless otherwise specified)

Parameter	Symbol	Rating	Unit
Operating Temperature	T_{OPR}	-40 to +100	$^\circ\text{C}$
Storage Temperature	T_{STG}	-40 to +100	$^\circ\text{C}$
Soldering Temperature (Iron) ^(2,3,4)	$T_{\text{SOL-I}}$	240 for 5 sec	$^\circ\text{C}$
Soldering Temperature (Flow) ^(2,3)	$T_{\text{SOL-F}}$	260 for 10 sec	$^\circ\text{C}$
Collector-Emitter Voltage	V_{CE}	30	V
Emitter-Collector Voltage	V_{EC}	5	V
Power Dissipation ⁽¹⁾	P_{D}	100	mW

Electrical/Optical Characteristics ($T_A = 25^\circ\text{C}$ unless otherwise specified)

Parameter	Test Conditions	Symbol	Min	Typ	Max	Units	
Peak Sensitivity		λ_{PS}	—	880	—	nM	
Reception Angle		Q	—	± 25	—	Deg.	
Collector Emitter Dark Current	$V_{\text{CE}} = 10 \text{ V}, E_e = 0$	I_{D}	—	—	100	nA	
Collector Emitter Breakdown	$I_{\text{C}} = 1 \text{ mA}$	BV_{CEO}	30	—	—	V	
Emitter Collector Breakdown	$I_{\text{E}} = 100 \mu\text{A}$	BV_{ECO}	5	—	—	V	
On-State Collector Current	$E_e = 0.5 \text{ mW/cm}^2, V_{\text{CE}} = 5 \text{ V}$	$I_{\text{C(ON)}}$	(QSE213)	0.2	—	1.50	mA
			(QSE214)	1.00	—	—	
Saturation Voltage	$V_{\text{CE}} = 5 \text{ V}^{(5)}, E_e = 0.5 \text{ mW/cm}^2, I_{\text{C}} = 0.1 \text{ mA}^{(5)}$	$V_{\text{CE(SAT)}}$	—	—	0.4	V	
Rise Time	$V_{\text{CC}} = 5\text{V}, R_{\text{L}} = 100\Omega, I_{\text{C}} = 1\text{mA}$	t_{r}	—	8	—	μs	
Fall Time		t_{f}	—	8	—		

Notes:

1. Derate power dissipation linearly 1.33 mW/ $^\circ\text{C}$ above 25°C .
2. RMA flux is recommended.
3. Methanol or isopropyl alcohols are recommended as cleaning agents.
4. Soldering iron 1/16" (1.6 mm) minimum from housing.
5. $\lambda = 950 \text{ nm}$ GaAs.

Typical Performance Curves

Fig. 1 Dark Current vs. Collector Emitter Voltage

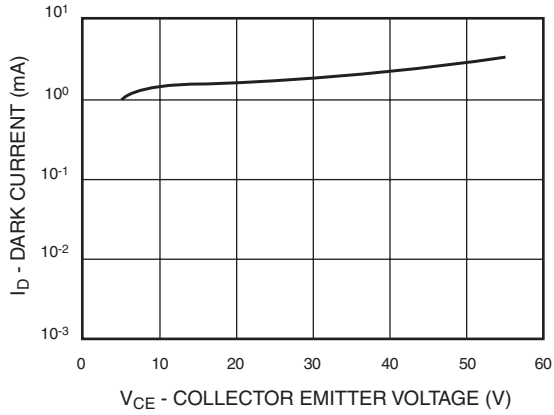

Fig. 2 Radiation Diagram

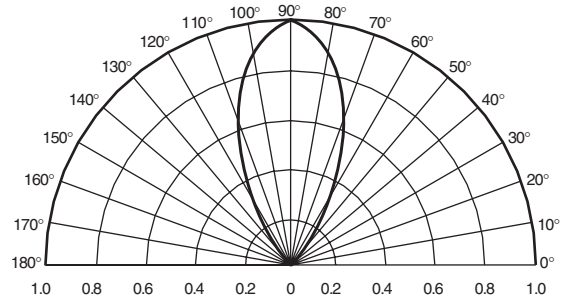

Fig. 3 Light Current vs. Ambient Temperature

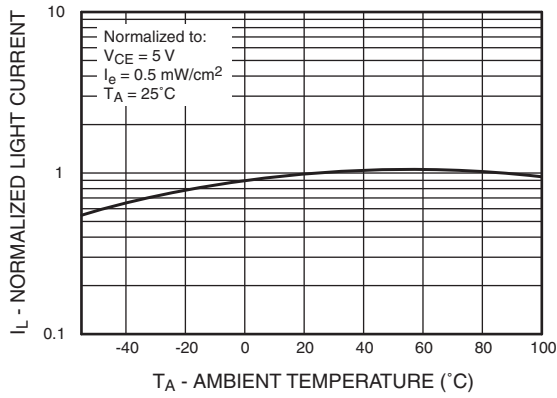

Fig. 4 Light Current vs. Collector to Emitter Voltage

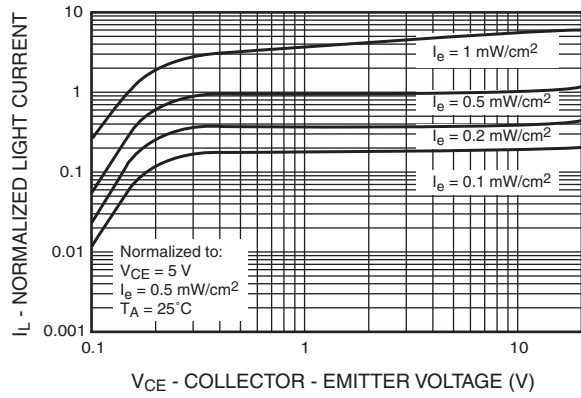
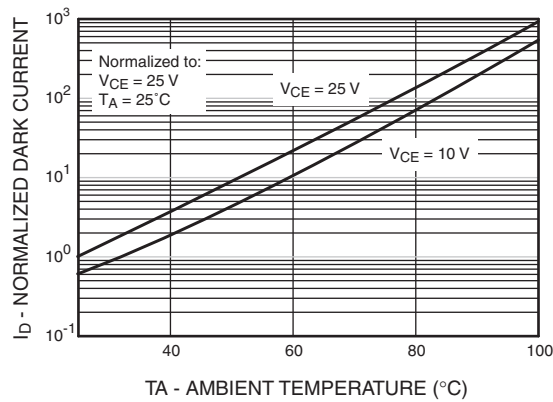

Fig. 5 Dark Current vs. Ambient Temperature



TRADEMARKS

The following are registered and unregistered trademarks Fairchild Semiconductor owns or is authorized to use and is not intended to be an exhaustive list of all such trademarks.

ACEx™	FAST®	IntelliMAX™	POP™	SPM™
ActiveArray™	FASTr™	ISOPLANAR™	Power247™	Stealth™
Bottomless™	FPS™	LittleFET™	PowerEdge™	SuperFET™
CoolFET™	FRFET™	MICROCOUPLER™	PowerSaver™	SuperSOT™-3
CROSSVOLT™	GlobalOptoisolator™	MicroFET™	PowerTrench®	SuperSOT™-6
DOME™	GTO™	MicroPak™	QFET®	SuperSOT™-8
EcoSPARK™	HiSeC™	MICROWIRE™	QS™	SyncFET™
E ² CMOS™	PC™	MSX™	QT Optoelectronics™	TinyLogic®
EnSigna™	i-Lo™	MSXPro™	Quiet Series™	TINYOPTO™
FACT™	ImpliedDisconnect™	OCX™	RapidConfigure™	TruTranslation™
FACT Quiet Series™		OCXPro™	RapidConnect™	UHC™
Across the board. Around the world.™		OPTOLOGIC®	µSerDes™	UltraFET®
The Power Franchise®		OPTOPLANAR™	SILENT SWITCHER®	UniFET™
Programmable Active Droop™		PACMAN™	SMART START™	VCX™

DISCLAIMER

FAIRCHILD SEMICONDUCTOR RESERVES THE RIGHT TO MAKE CHANGES WITHOUT FURTHER NOTICE TO ANY PRODUCTS HEREIN TO IMPROVE RELIABILITY, FUNCTION OR DESIGN. FAIRCHILD DOES NOT ASSUME ANY LIABILITY ARISING OUT OF THE APPLICATION OR USE OF ANY PRODUCT OR CIRCUIT DESCRIBED HEREIN; NEITHER DOES IT CONVEY ANY LICENSE UNDER ITS PATENT RIGHTS, NOR THE RIGHTS OF OTHERS.

LIFE SUPPORT POLICY

FAIRCHILD'S PRODUCTS ARE NOT AUTHORIZED FOR USE AS CRITICAL COMPONENTS IN LIFE SUPPORT DEVICES OR SYSTEMS WITHOUT THE EXPRESS WRITTEN APPROVAL OF FAIRCHILD SEMICONDUCTOR CORPORATION. As used herein:

1. Life support devices or systems are devices or systems which, (a) are intended for surgical implant into the body, or (b) support or sustain life, or (c) whose failure to perform when properly used in accordance with instructions for use provided in the labeling, can be reasonably expected to result in significant injury to the user.
2. A critical component is any component of a life support device or system whose failure to perform can be reasonably expected to cause the failure of the life support device or system, or to affect its safety or effectiveness.

PRODUCT STATUS DEFINITIONS**Definition of Terms**

Datasheet Identification	Product Status	Definition
Advance Information	Formative or In Design	This datasheet contains the design specifications for product development. Specifications may change in any manner without notice.
Preliminary	First Production	This datasheet contains preliminary data, and supplementary data will be published at a later date. Fairchild Semiconductor reserves the right to make changes at any time without notice in order to improve design.
No Identification Needed	Full Production	This datasheet contains final specifications. Fairchild Semiconductor reserves the right to make changes at any time without notice in order to improve design.
Obsolete	Not In Production	This datasheet contains specifications on a product that has been discontinued by Fairchild semiconductor. The datasheet is printed for reference information only.

Rev. 115