

**Descriptions**

- General purpose application
- Switching application

**Features**

- High voltage :  $V_{CEO} = -55V$
- Complementary pair with SBC546

**Ordering Information**

Type NO.	Marking	Package Code
SBC556	SBC556	TO-92

**Outline Dimensions**

unit : mm

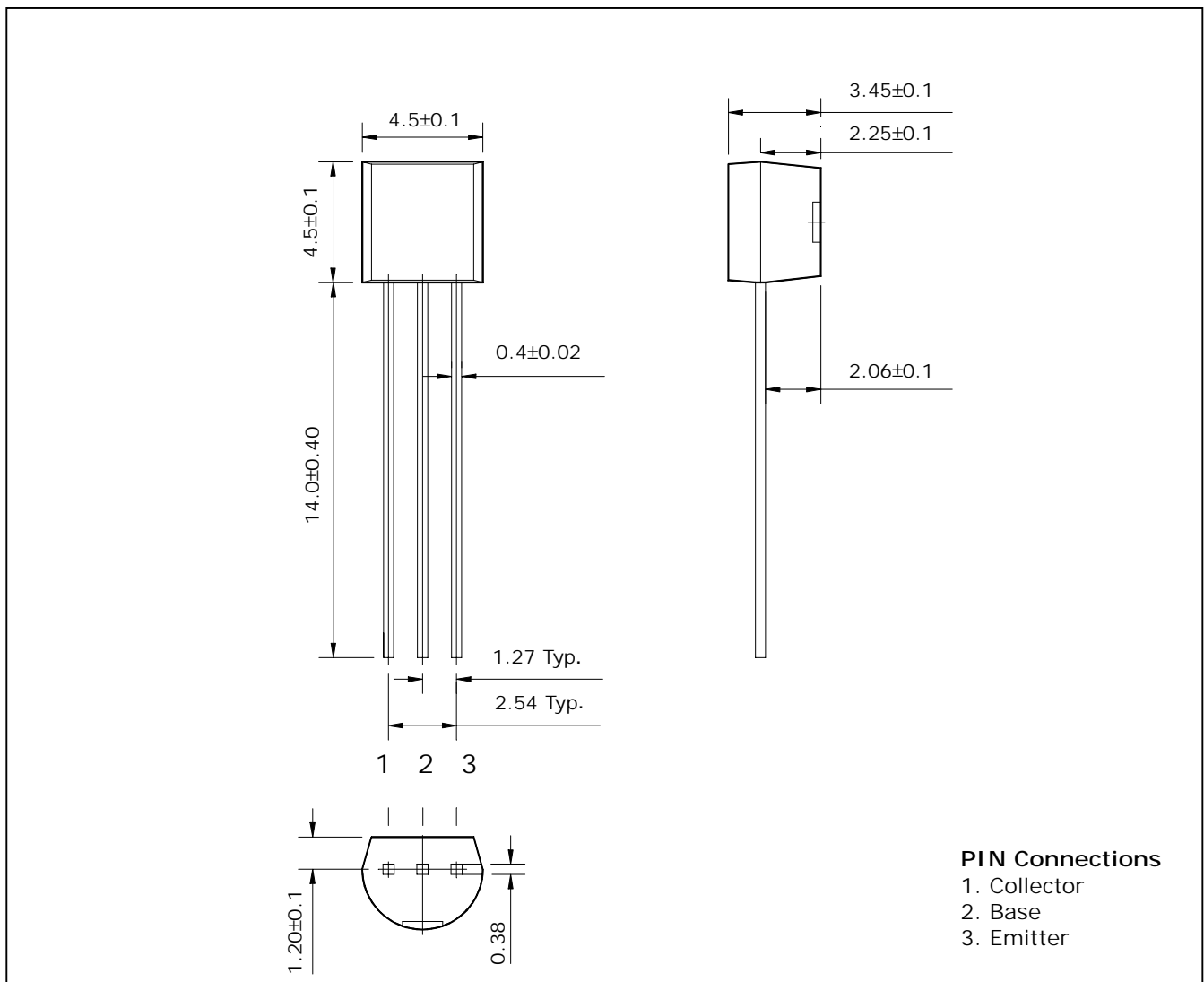

## Absolute maximum ratings

(Ta=25°C)

Characteristic	Symbol	Ratings	Unit
Collector-Base voltage	$V_{CBO}$	-80	V
Collector-Emitter voltage	$V_{CEO}$	-55	V
Emitter-Base voltage	$V_{EBO}$	-5	V
Collector current	$I_C$	-100	mA
Collector dissipation	$P_C$	625	mW
Junction temperature	$T_J$	150	°C
Storage temperature	$T_{stg}$	-55 ~ 150	°C

## Electrical Characteristics

(Ta=25°C)

Characteristic	Symbol	Test Condition	Min.	Typ.	Max.	Unit
Collector-Emitter breakdown voltage	$BV_{CEO}$	$I_C = -2mA, I_B = 0$	-55	-	-	V
Base-Emitter turn on voltage	$V_{BE(ON)}$	$V_{CE} = -5V, I_C = -2mA$	-	-	-700	mV
Base-Emitter saturation voltage	$V_{BE(sat)}$	$I_C = -100mA, I_B = -5mA$	-	-900	-	mV
Collector-Emitter saturation voltage	$V_{CE(sat)}$	$I_C = -100mA, I_B = -5mA$	-	-	-650	mV
Collector cut-off current	$I_{CBO}$	$V_{CB} = -35V, I_E = 0$	-	-	-15	nA
DC current gain	$h_{FE}^*$	$V_{CE} = -5V, I_C = -2mA$	110	-	800	-
Transition frequency	$f_T$	$V_{CB} = -5V, I_C = -10mA$	-	150	-	MHz
Collector output capacitance	$C_{ob}$	$V_{CB} = -10V, I_E = 0, f = 1MHz$	-	-	4.5	pF
Noise figure	NF	$V_{CE} = -5V, I_C = -200\mu A, f = 1KHz, R_g = 2K\Omega$	-	-	10	dB

\* :  $h_{FE}$  rank / A : 110 ~ 220, B : 200 ~ 450, C : 420 ~ 800

Electrical Characteristic Curves

Fig. 1  $P_C$ - $T_a$

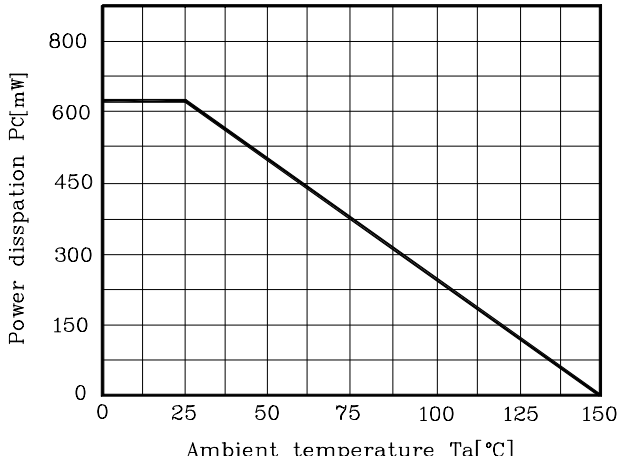

Fig. 2  $I_C$ - $V_{BE}$

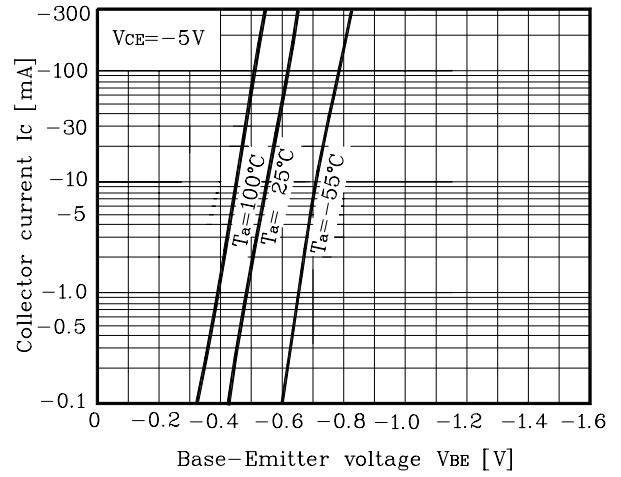

Fig. 3  $I_C$ - $V_{CE}$

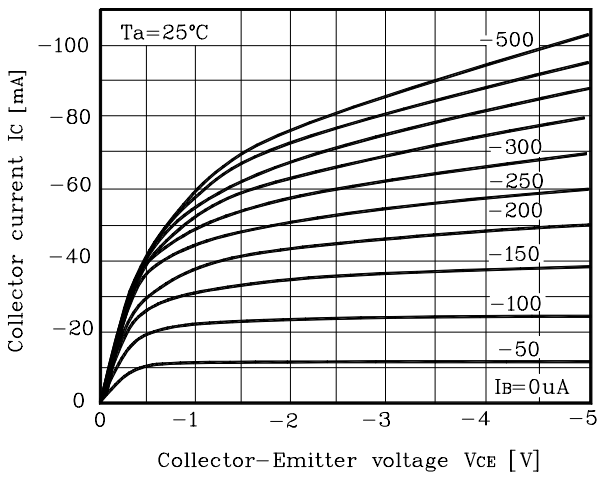

Fig. 4  $h_{FE}$ - $I_C$

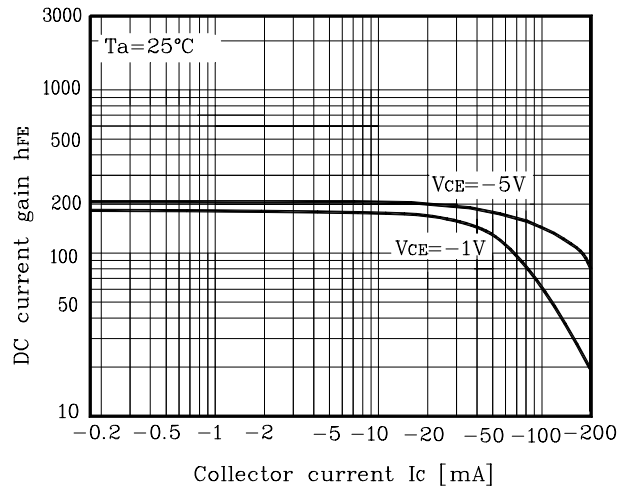

Fig. 5  $V_{CE(sat)}$ - $I_C$

