



P-Channel 12-V (D-S) MOSFET

PRODUCT SUMMARY		
V_{DS} (V)	$r_{DS(on)}$ (Ω)	I_D (A)
-12	0.016 @ $V_{GS} = -4.5$ V	-12.6
	0.022 @ $V_{GS} = -2.5$ V	-10.8
	0.029 @ $V_{GS} = -1.8$ V	-3.5

FEATURES

- TrenchFET® Power MOSFETS: 1.8-V Rated
- New PowerPAK® Package
 - Low Thermal Resistance, R_{thJC}
 - Low 1.07-mm Profile

APPLICATIONS

- Load Switch
- PA Switch
- Battery Switch

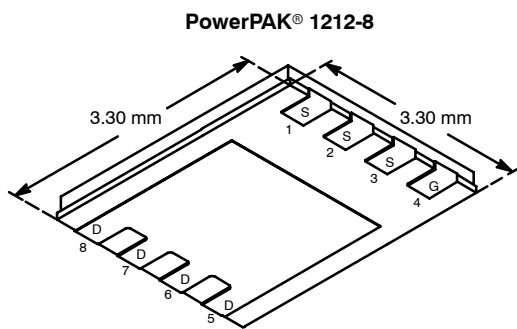

Bottom View

Ordering Information: Si7425DN-T1—E3

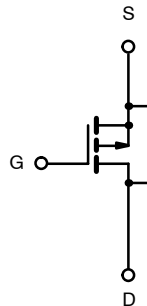

P-Channel MOSFET

ABSOLUTE MAXIMUM RATINGS ($T_A = 25^\circ\text{C}$ UNLESS OTHERWISE NOTED)					
Parameter	Symbol	10 secs	Steady State	Unit	
Drain-Source Voltage	V_{DS}	-12		V	
Gate-Source Voltage	V_{GS}	± 8			
Continuous Drain Current ($T_J = 150^\circ\text{C}$) ^a	I_D	$T_A = 25^\circ\text{C}$	-12.6	-8.3	A
		$T_A = 85^\circ\text{C}$	-9.1	-6.0	
Pulsed Drain Current	I_{DM}	-25			
continuous Source Current (Diode Conduction) ^a	I_S	-3.0	-1.3		
Maximum Power Dissipation ^a	P_D	$T_A = 25^\circ\text{C}$	3.6	1.5	W
		$T_A = 85^\circ\text{C}$	1.9	0.8	
Operating Junction and Storage Temperature Range	T_J, T_{stg}	-55 to 150		$^\circ\text{C}$	

THERMAL RESISTANCE RATINGS					
Parameter	Symbol	Typical	Maximum	Unit	
Maximum Junction-to-Ambient ^a	R_{thJA}	$t \leq 10$ sec	28	35	$^\circ\text{C/W}$
		Steady State	65	81	
Maximum Junction-to-Case	R_{thJC}	2.9	3.8		

Notes

a. Surface Mounted on 1" x 1" FR4 Board.

SPECIFICATIONS (T_J = 25 °C UNLESS OTHERWISE NOTED)

Parameter	Symbol	Test Condition	Min	Typ	Max	Unit
Static						
Gate Threshold Voltage	V _{GS(th)}	V _{DS} = V _{GS} , I _D = -300 μA	-0.40		-1.0	V
Gate-Body Leakage	I _{GSS}	V _{DS} = 0 V, V _{GS} = ±8 V			±100	nA
Zero Gate Voltage Drain Current	I _{DSS}	V _{DS} = -12 V, V _{GS} = 0 V			-1	μA
		V _{DS} = -12 V, V _{GS} = 0 V, T _J = 85 °C			-5	
On-State Drain Current ^a	I _{D(on)}	V _{DS} ≤ -5 V, V _{GS} = -4.5 V	-25			A
Drain-Source On-State Resistance ^a	r _{DS(on)}	V _{GS} = -4.5 V, I _D = -12.6 A		0.013	0.016	Ω
		V _{GS} = -2.5 V, I _D = -10.8 A		0.017	0.022	
		V _{GS} = -1.8 V, I _D = -3.5 A		0.023	0.029	
Forward Transconductance ^a	g _{fs}	V _{DS} = -6 V, I _D = -12.6 A		38		S
Diode Forward Voltage ^a	V _{SD}	I _S = -3.0 A, V _{GS} = 0 V		-0.7	-1.2	V
Dynamic^b						
Total Gate Charge	Q _g	V _{DS} = -6 V, V _{GS} = -4.5 V, I _D = -12.6 A		26	39	nC
Gate-Source Charge	Q _{gs}		4.1			
Gate-Drain Charge	Q _{gd}		7.0			
Gate Resistance	R _g	f = 1 MHz		5.0		Ω
Turn-On Delay Time	t _{d(on)}	V _{DD} = -6 V, R _L = 6 Ω I _D ≅ -1 A, V _{GEN} = -4.5 V, R _G = 6 Ω		30	45	ns
Rise Time	t _r		55	75		
Turn-Off Delay Time	t _{d(off)}		130	260		
Fall Time	t _f		100	225		
Source-Drain Reverse Recovery Time	t _{rr}		I _F = -3.2 A, di/dt = 100 A/μs		52	

Notes

- a. Pulse test; pulse width ≤ 300 μs, duty cycle ≤ 2%.
b. Guaranteed by design, not subject to production testing.

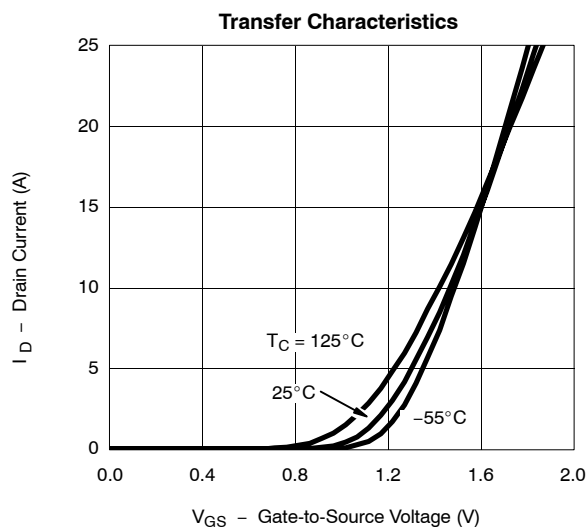
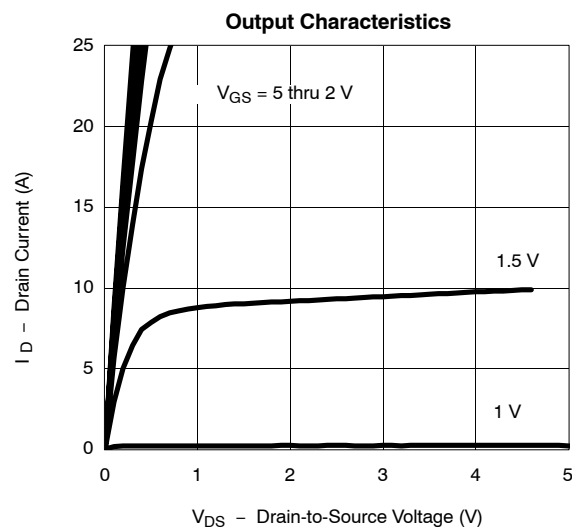
TYPICAL CHARACTERISTICS (25 °C UNLESS NOTED)



TYPICAL CHARACTERISTICS (25 °C UNLESS NOTED)

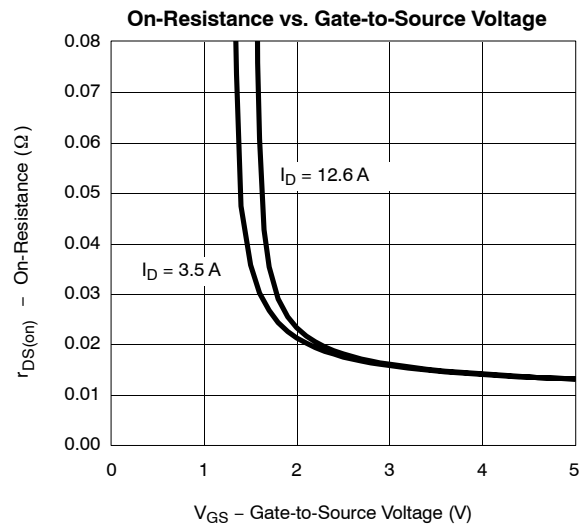
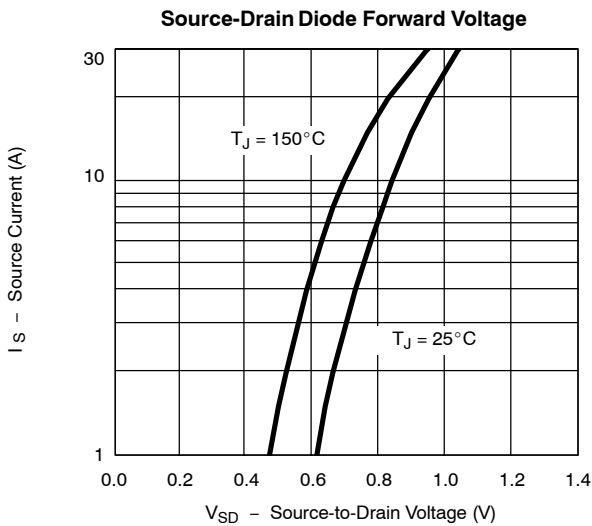
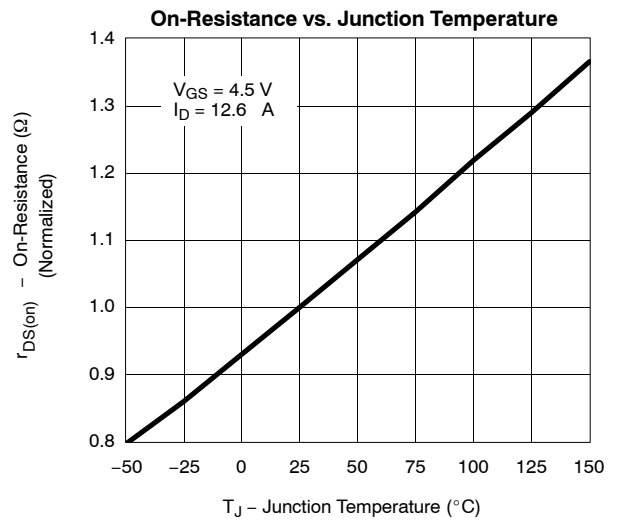
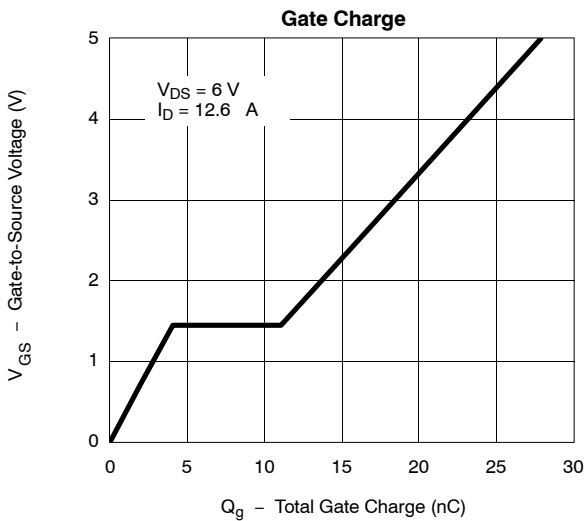
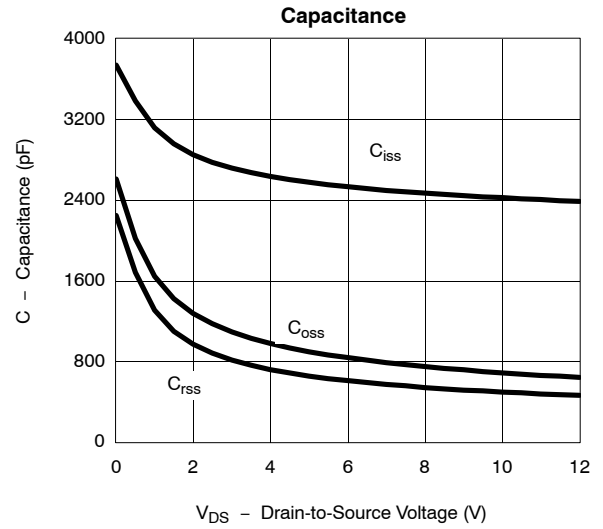
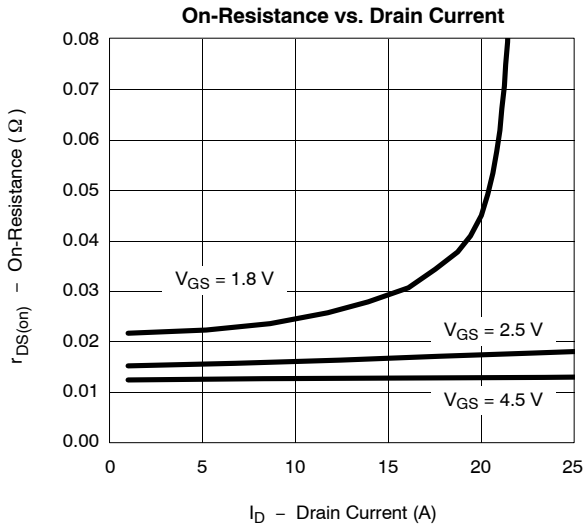

TYPICAL CHARACTERISTICS (25 °C UNLESS NOTED)

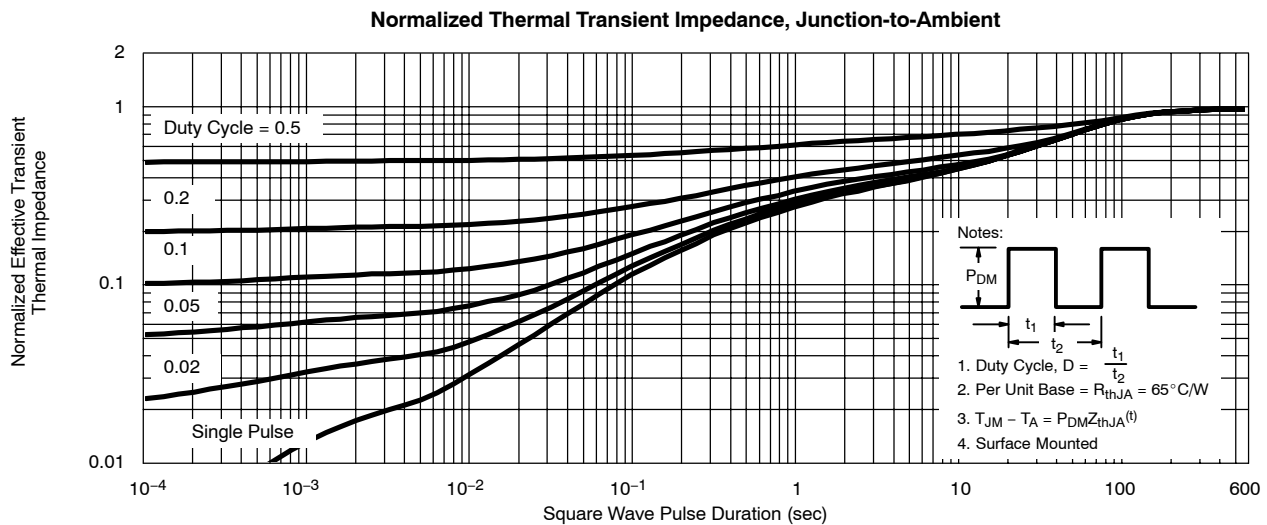
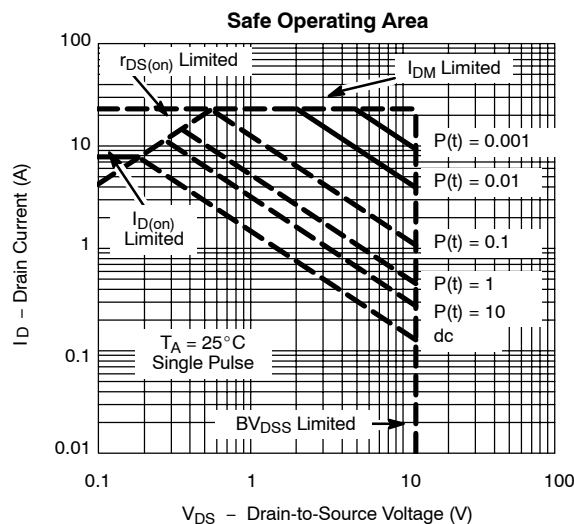
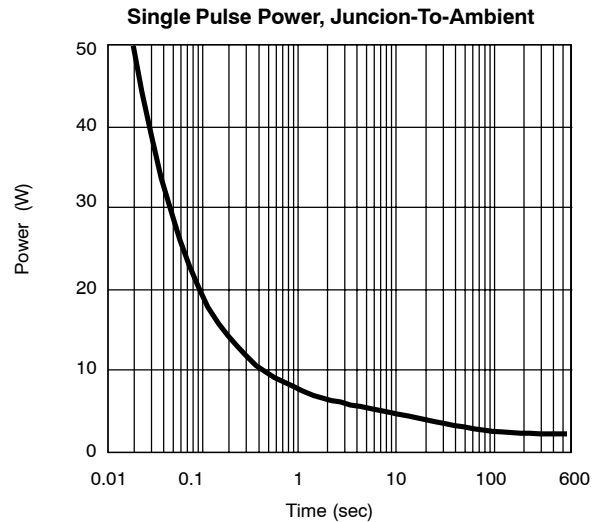
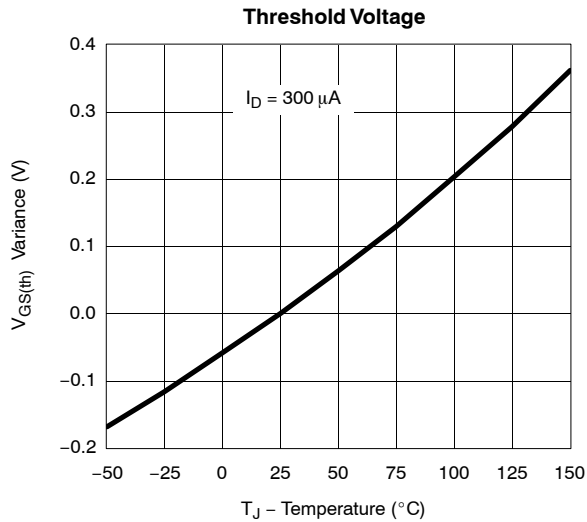



TYPICAL CHARACTERISTICS (25 °C UNLESS NOTED)

