

SKM 121AR



SEMITRANS™ M1

Power MOSFET Modules

SKM 121AR

Features

- N Channel, enhancement mode
- Avalanche characteristics
- Short internal connections avoid oscillations
- Isolated copper baseplates
- All electrical connections on top for easy busbaring
- Large clearance (10mm) and creepage distances (13mm)
- UL recognized, file no. E 63 532

Typical Applications

- Switched mode power supplies
- DC servo and robot drives
- DC choppers
- UPS equipment
- Plasma cutting
- Not suitable for linear amplification



MA

Absolute Maximum Ratings		$T_c = 25\text{ }^\circ\text{C}$, unless otherwise specified	
Symbol	Conditions	Values	Units
V_{DS}		200	V
I_D	$T_s = 25\text{ (80) }^\circ\text{C}$	130 (95)	A
I_{DM}	1 ms	390	A
V_{GS}		± 20	V
T_{vj} (T_{stg})		- 40 ... + 150 (125)	$^\circ\text{C}$
V_{isol}	AC, 1 min.	2500	V
Inverse diode			
$I_F = -I_S$		130	A
$I_{FM} = -I_{SM}$		390	A

Characteristics		$T_c = 25\text{ }^\circ\text{C}$, unless otherwise specified			
Symbol	Conditions	min.	typ.	max.	Units
$V_{(BR)DSS}$	$V_{GS} = 0\text{ V}$, $I_D = 0,25\text{ mA}$	200			V
$V_{GS(th)}$	$V_{GS} = V_{DS}$, $I_D = 1\text{ mA}$	2,1	3	4	V
I_{DSS}	$V_{GS} = 0\text{ V}$, $V_{DS} = 200\text{ V}$, $T_j = 25\text{ (125) }^\circ\text{C}$		50 (300)	250 (1000)	μA
I_{GSS}	$V_{GS} = 20\text{ V}$, $V_{DS} = 0\text{ V}$		10	100	nA
$R_{DS(on)}$	$V_{GS} = 10\text{ V}$, $I_D = 80\text{ A}$		18	20	m Ω
g_{fs}	$V_{DS} = 25\text{ V}$, $I_D = 80\text{ A}$	60	75		S
C_{CHC}	$V_{GS} = 0$, $V_{DS} = 25\text{ V}$, $f = 1\text{ MHz}$			160	pF
C_{iss}			10	13	nF
C_{oss}			3	4,5	nF
C_{rss}			0,7	1	nF
L_{DS}				20	nH
$t_{d(on)}$	$V_{DD} = 100\text{ V}$, $I_D = 80\text{ A}$,		60		ns
t_r	$V_{GS} = 10\text{ V}$, $R_G = 3,3\text{ }\Omega$		60		ns
$t_{d(off)}$			240		ns
t_f			70		ns
Inverse diode					
V_{SD}	$I_F = 260\text{ A}$; $V_{GS} = 0\text{ V}$		1,05	1,4	V
t_{rr}	$T_j = 25\text{ (150) }^\circ\text{C}$		400		ns
Q_{rr}	$T_j = 25\text{ }^\circ\text{C}$		4,3		μC
I_{rr}	$T_j = \text{ }^\circ\text{C}$				A
Thermal characteristics					
$R_{th(j-c)}$	per MOSFET			0,18	K/W
$R_{th(c-s)}$	M_s , surface $10\text{ }\mu\text{m}$, per module			0,05	K/W
Mechanical data					
M_s	to heatsink (M6)	4		5	Nm
M_t	for terminals (M5)	2,5		3,5	Nm
w				130	g

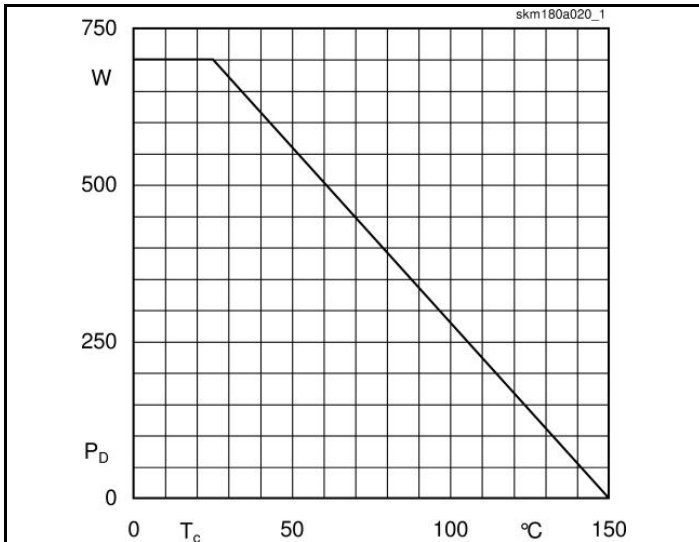

Fig. 1 Rated power dissipation vs. temperature

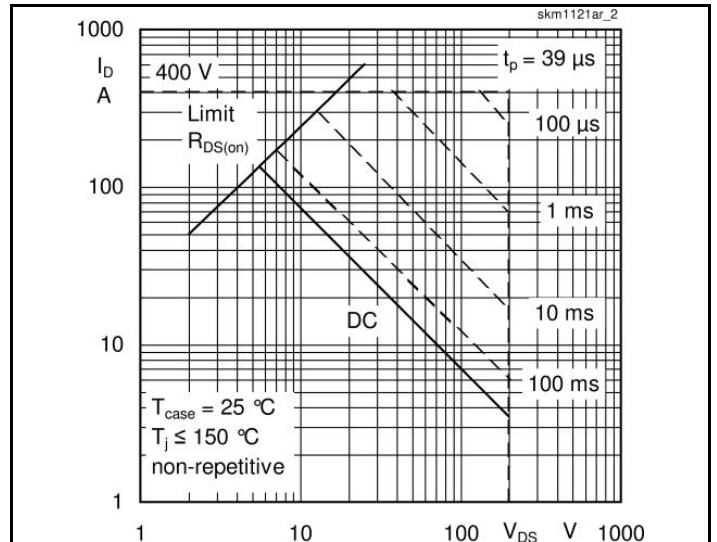

Fig. 2 Maximum safe operating area

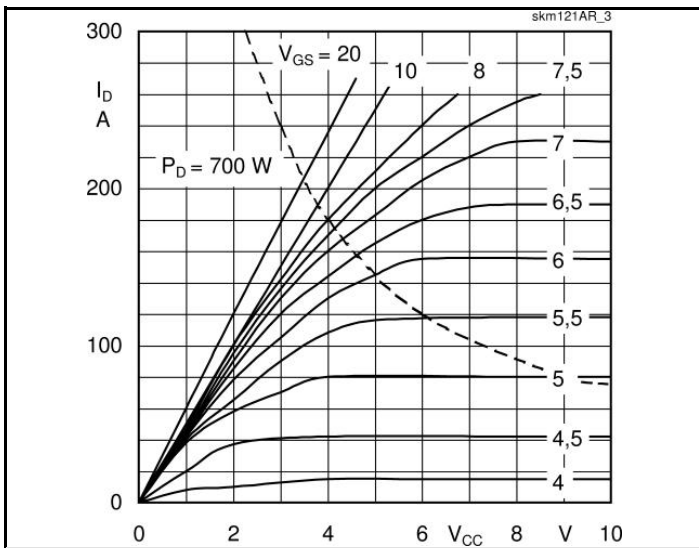

Fig. 3 Output characteristic

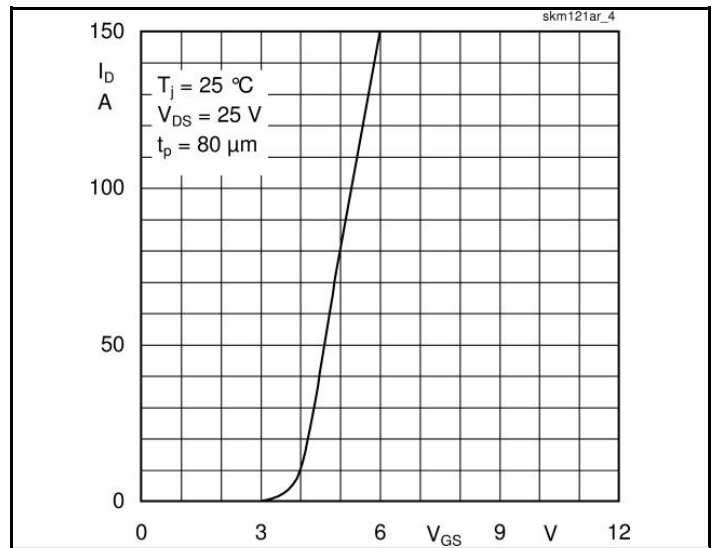

Fig. 4 Transfer characteristic

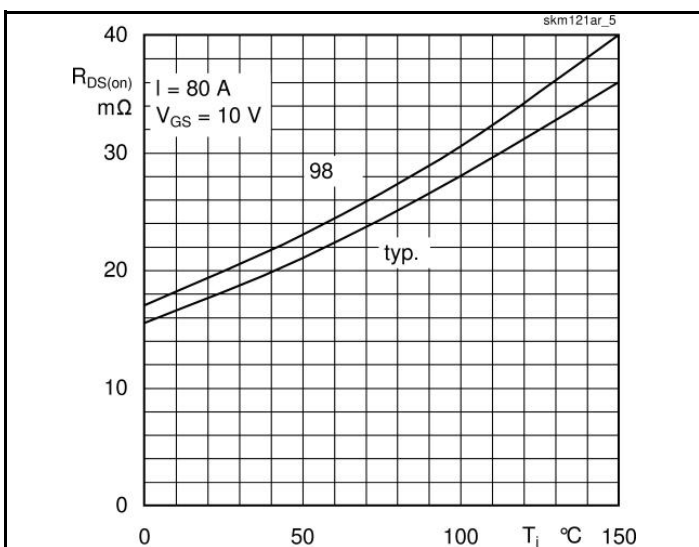

Fig. 5 On-resistance vs. temperature

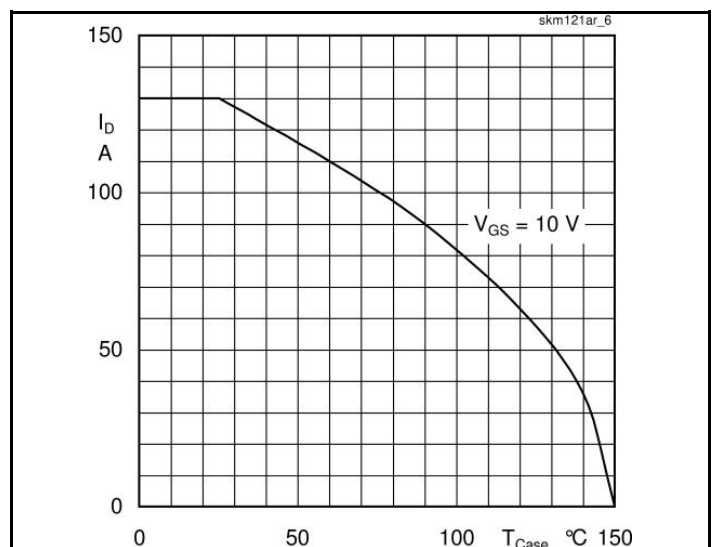
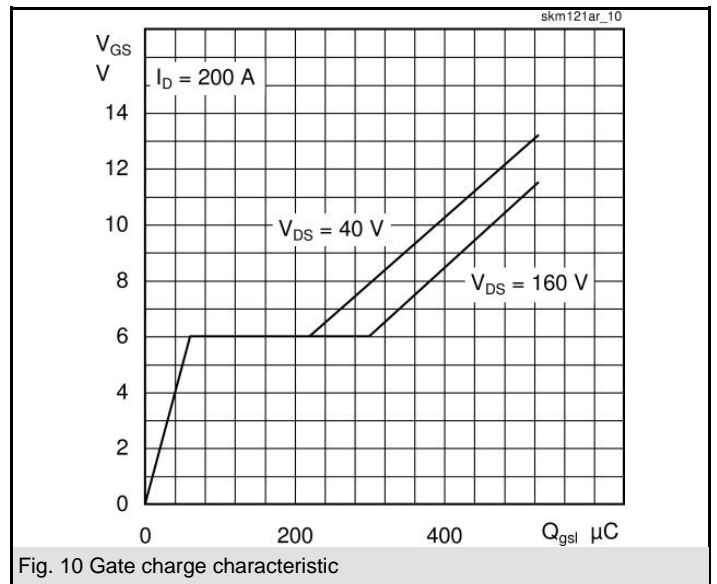
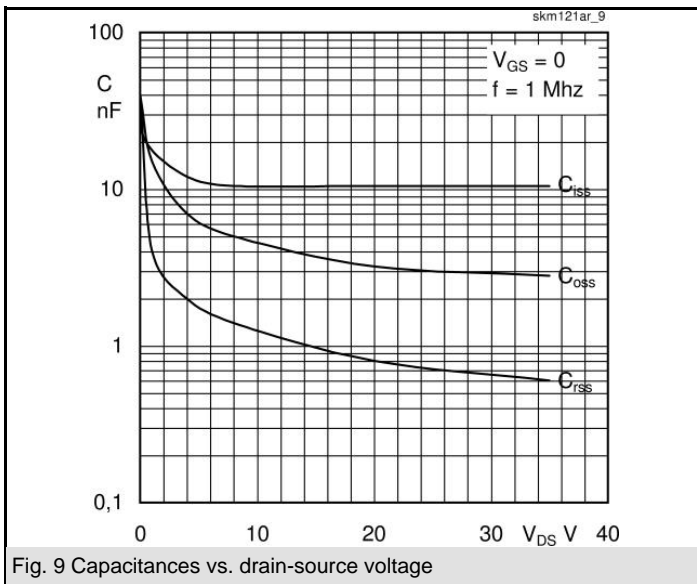
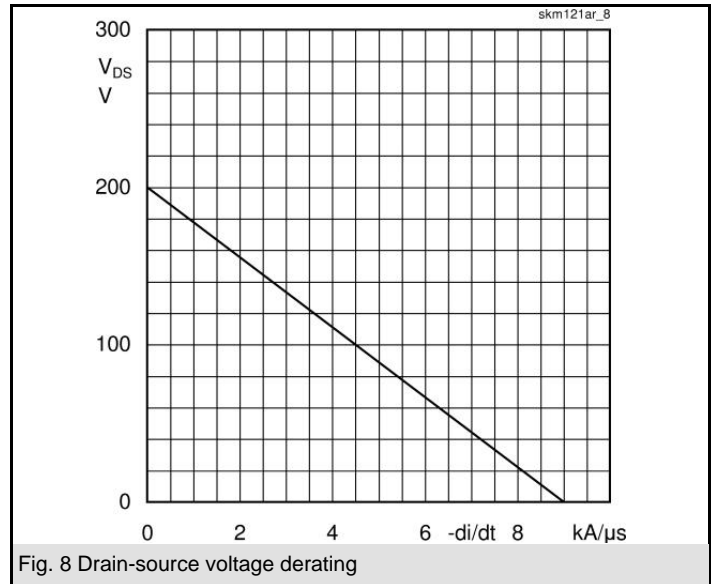
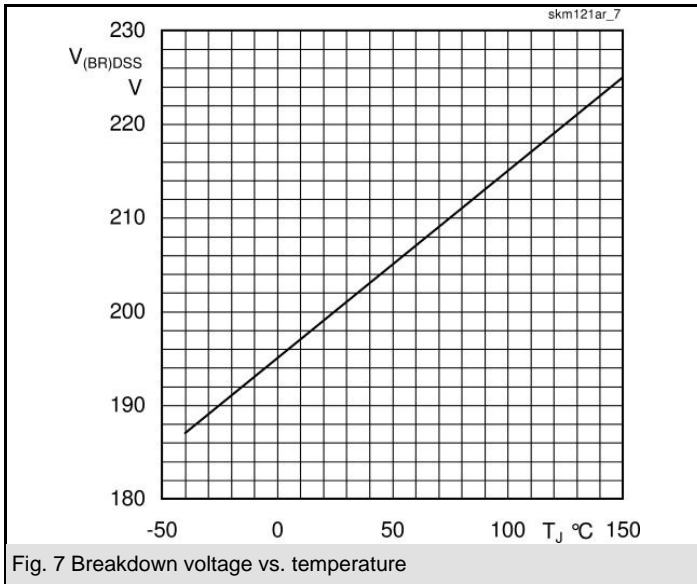

Fig. 6 Rated current vs. temperature



SKM 121AR

UL Recognized
File no. E 63 532

Dimensions in mm

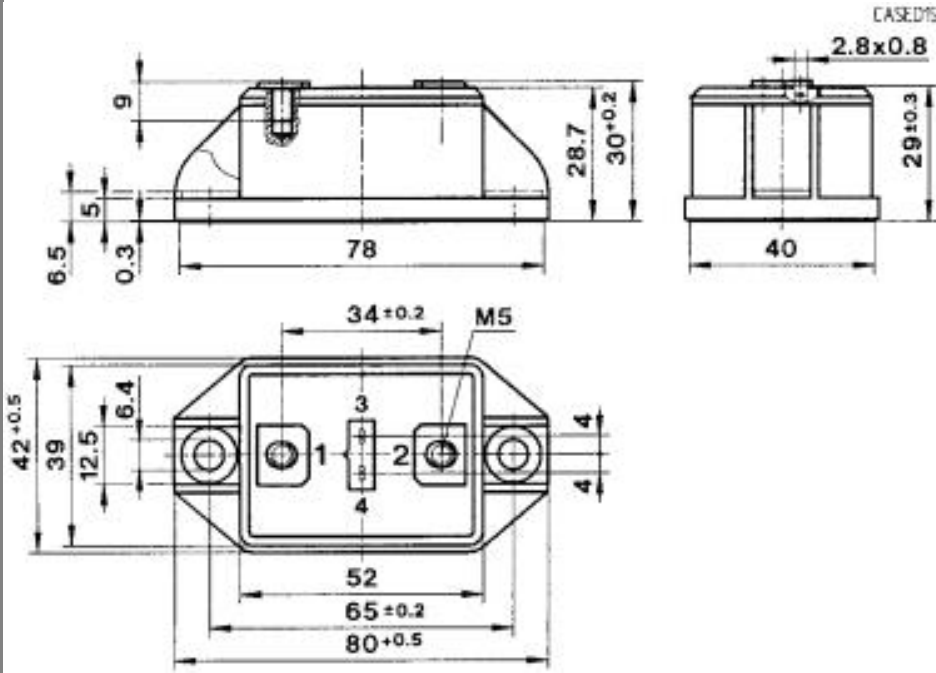

Case D 15

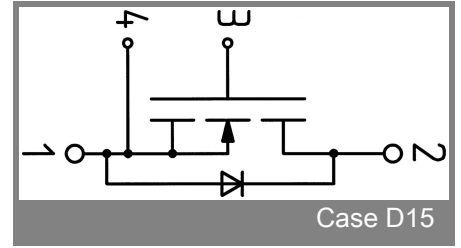

This is an electrostatic discharge sensitive device (ESDS), international standard IEC 60747-1, Chapter IX.

This technical information specifies semiconductor devices but promises no characteristics. No warranty or guarantee expressed or implied is made regarding delivery, performance or suitability.