

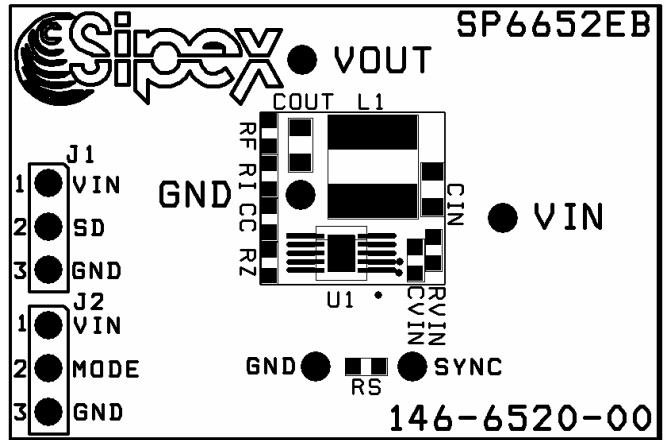

SP6652EB Evaluation Board Manual

- High Efficiency Synchronous Step-Down Converter with up to 97% efficiency
- 1000mA Output Current
- 2.7V-5.5V Input Voltage range, Output Adjustable down to 0.8V
- μ SOIC Package & Ceramic Capacitors for small, low profile Power Supply
- Ideal for PDAs, Digital Cameras, Wireless Modems, Cellular Telephones



DESCRIPTION

The **SP6652 Evaluation Board** is designed to help the user evaluate the performance of the SP6652 for use as a single Li-Ion battery Step-Down DC-DC Converter. The SP6652 operates from 2.7V to 6.5V input, with the highest efficiency in the range 3.0V to 4.2V where the Li-Ion battery has the most energy. The SP6652EB evaluation board is a complete power supply circuit to provide ease of evaluation for the DC/DC Converter performance.

SP6652 3.3V OUTPUT EVALUATION BOARD SCHEMATIC

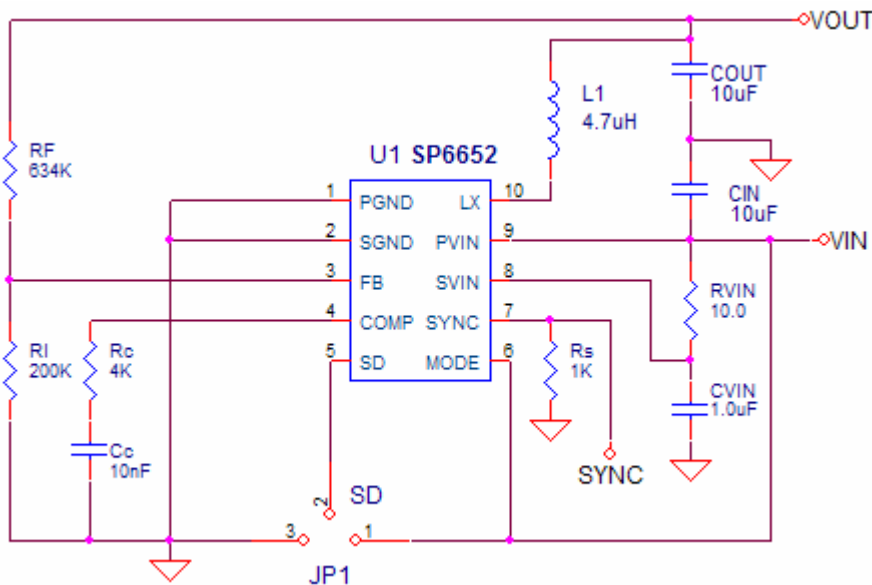

USING THE EVALUATION BOARD

1) Powering up the SP6652 Circuit & Programming the UVLO threshold

The SP6652 Evaluation Board can be powered from a single Li-Ion battery or a +2.7 to +5.0V power supply. Connect with short leads directly to the “Vin” and “Gnd” posts. Note the SP6652 will remain in “shutdown” until SD pin Jumper J1 is applied to the VIN position pin 1 to 2.

2) VOUT PROGRAMMING

The SP6652 requires 2 feedback resistors to control the output voltage. Connect the appropriate resistors RF and RI (Table 2) from pin 3 SP6652 FB to Vout and to the GND.

For Vout different from that shown in the schematic, use equation:

$$RF = \left(\frac{V_{out}}{0.80} - 1 \right) \cdot RI$$

SP6652EB BILL OF MATERIALS

Component	Vo = 3.3V
L1	4.7uH, Wurth Elektronik 744042004, 0.07ohm, 1.7A, 4.8x4.8x1.8mm
CIN	10uF, TDK C2012X5R0J106M, 0.005ohm, 6.3V, X5R, 0805
COUT	10uF, TDK C2012X5R0J106M, 0.005ohm, 6.3V, X5R, 0805
CVIN	1uF, TDK C1608X5R0J105M, 0.03ohm, .3V, X5R, 0603
Cc	10nF ceramic, 0603
RVIN	10 Ohm 5%, 0603
RI	200k 1%, 0603
RF	634k 1%, 0603
Rz	4.02k 1%, 0603
U1	SP6652EU, 10 pin uSOIC

3) POWER SUPPLY DATA

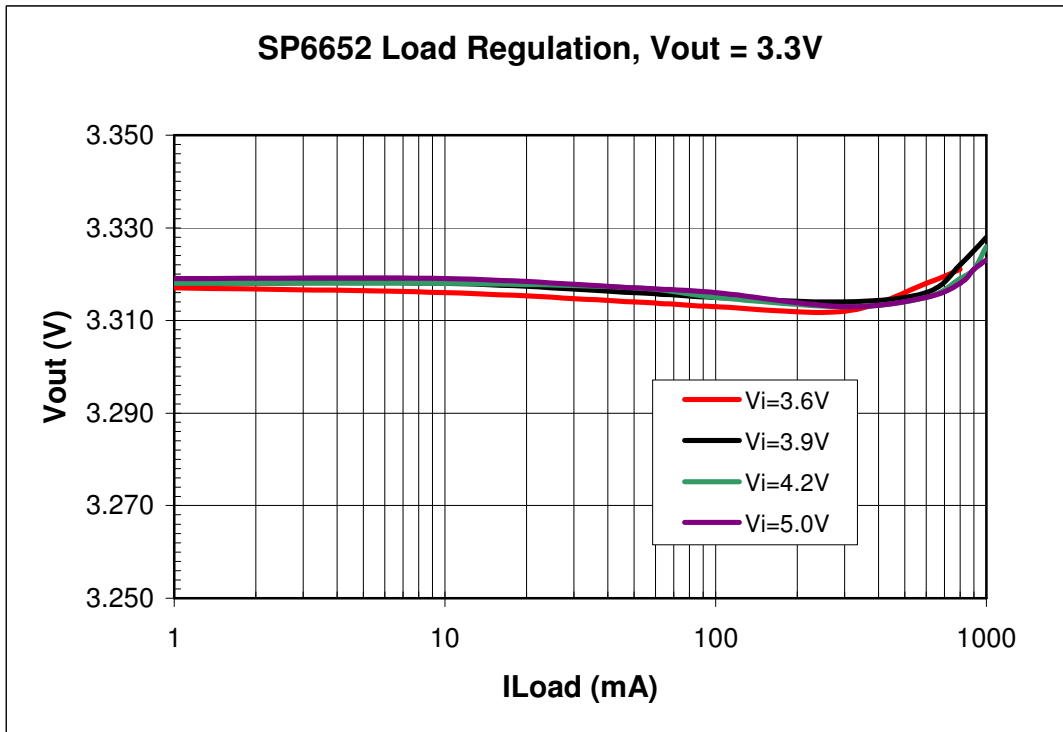
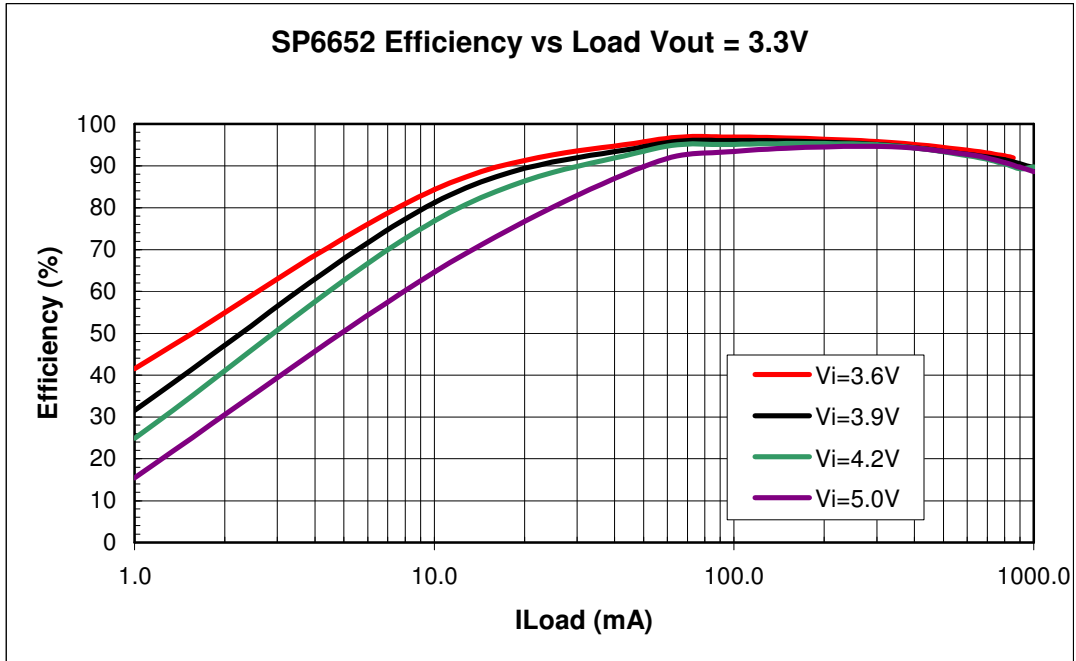

4) EVALUATION BOARD LAYOUT

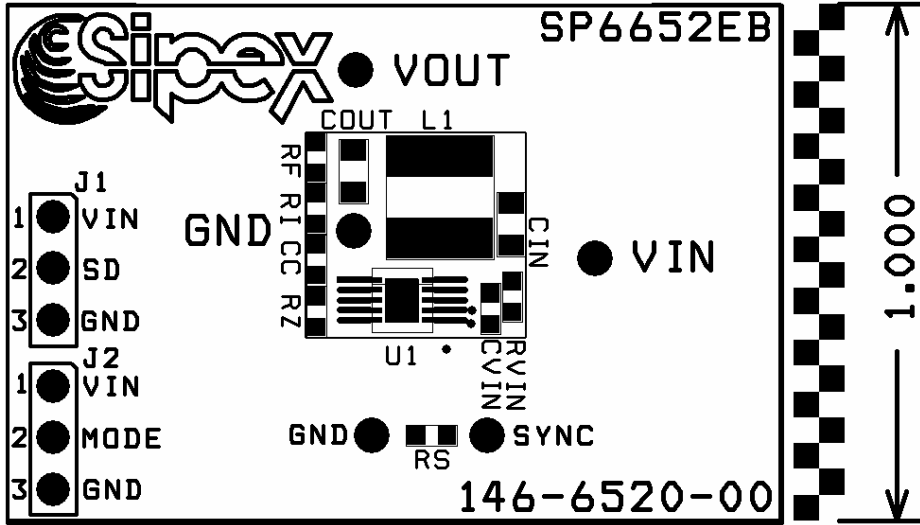

SP6652EB COMPONENT PLACEMENT

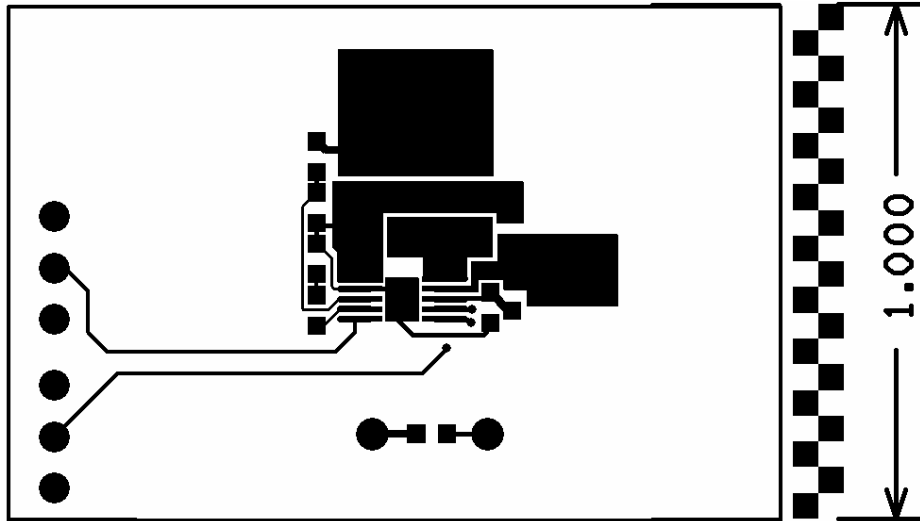

SP6652EB PC LAYOUT TOP SIDE

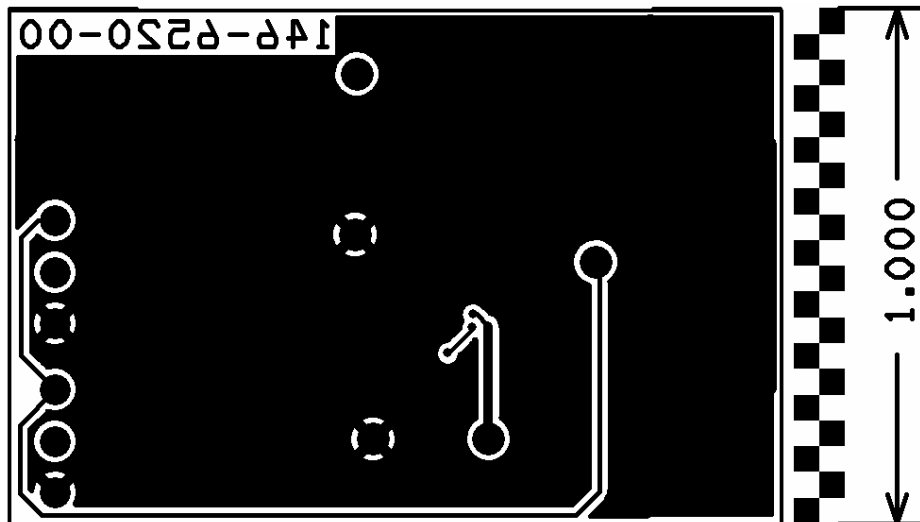

SP6652EB PC LAYOUT BOTTOM SIDE