

Rail-to-rail CMOS quad operational amplifier

Features

- Rail-to-rail input and output voltage ranges
- Single (or dual) supply operation from 2.7V to 16V
- Extremely low input bias current: 1pA typ
- Low input offset voltage: 5mV max.
- Specified for 600Ω and 100Ω loads
- Low supply current: 200μA/ampli ($V_{CC} = 3V$)
- Latch-up immunity
- Spice macromodel included in this specification

Description

The TS914 is a rail-to-rail CMOS quad operational amplifier designed to operate with a single or dual supply voltage.

The input voltage range V_{icm} includes the two supply rails V_{CC}^+ and V_{CC}^- .

The output reaches:

- $V_{CC}^- + 50mV$, $V_{CC}^+ - 50mV$, with $R_L = 10k\Omega$
- $V_{CC}^- + 350mV$, $V_{CC}^+ - 350mV$, with $R_L = 600\Omega$

This product offers a broad supply voltage operating range from 2.7V to 16V and a supply current of only 200μA/amp ($V_{CC} = 3V$).

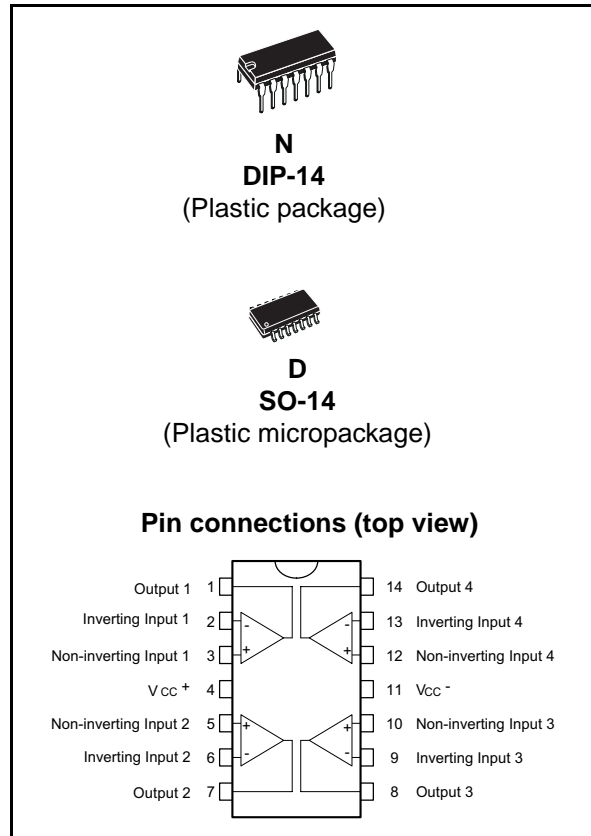

Source and sink output current capability is typically 40mA (at $V_{CC} = 3V$), fixed by an internal limitation circuit.

Order codes

Part number	Temperature range	Package	Packing	Marking
TS914IN	-40, +125°C	DIP14	Tube	TS914IN
TS914ID/IDT		SO-14	Tube or tape & reel	914I
TS914AIN		DIP14	Tube	TS914AIN
TS914AID/AIDT		SO-14	Tube or tape & reel	914AI
TS914IYD/IYDT		SO-14 (automotive grade level)	Tube or tape & reel	914IY
TS914AIYD/AIYDT				914AIY

Contents

- 1 Absolute maximum ratings and operating conditions 3**
- 2 Typical application information 4**
- 3 Electrical characteristics 5**
- 4 Macromodels 12**
 - 4.1 Important note concerning this macromodel 12
 - 4.2 Macromodel code 13
- 5 Package mechanical data 15**
 - 5.1 DIP-14 package 16
 - 5.2 SO-14 package 17
- 6 Revision history 18**

1 Absolute maximum ratings and operating conditions

Table 1. Absolute maximum ratings

Symbol	Parameter	Test conditions	Value	Unit
V_{CC}	Supply voltage ⁽¹⁾		18	V
V_{id}	Differential input voltage ⁽²⁾		± 18	V
V_i	Input voltage ⁽³⁾		-0.3 to 18	V
I_{in}	Current on inputs		± 50	mA
I_o	Current on outputs		± 130	mA
T_j	Maximum junction temperature		150	°C
T_{stg}	Storage temperature		-65 to +150	°C
R_{thja}	Thermal resistance junction to ambient ⁽⁴⁾	DIP-14	83	°C/W
		SO-14	103	
R_{thjc}	Thermal resistance junction to case	DIP-14	33	°C/W
		SO-14	31	
ESD	HBM: human body model ⁽⁵⁾		1	kV
	MM: machine model ⁽⁶⁾		50	V
	CDM: charged device model ⁽⁷⁾		1.5	kV

- All voltage values, except differential voltage are with respect to network ground terminal.
- Differential voltages are the non-inverting input terminal with respect to the inverting input terminal.
- The magnitude of input and output voltages must never exceed $V_{CC}^+ + 0.3V$.
- Short-circuits can cause excessive heating. Destructive dissipation can result from simultaneous short-circuit on all amplifiers. These are typical values.
- Human body model: A 100pF capacitor is charged to the specified voltage, then discharged through a 1.5k Ω resistor between two pins of the device. This is done for all couples of connected pin combinations while the other pins are floating.
- Machine model: A 200pF capacitor is charged to the specified voltage, then discharged directly between two pins of the device with no external series resistor (internal resistor < 5 Ω). This is done for all couples of connected pin combinations while the other pins are floating.
- Charged device model: all pins and the package are charged together to the specified voltage and then discharged directly to the ground through only one pin. This is done for all pins.

Table 2. Operating conditions

Symbol	Parameter	Value	Unit
V_{CC}	Supply voltage	2.7 to 16	V
V_{icm}	Common mode input voltage range	$V_{CC}^- - 0.2$ to $V_{CC}^+ + 0.2$	V
T_{oper}	Operating free air temperature range	-40 to + 125	°C

2 Typical application information

Figure 1. Typical application information

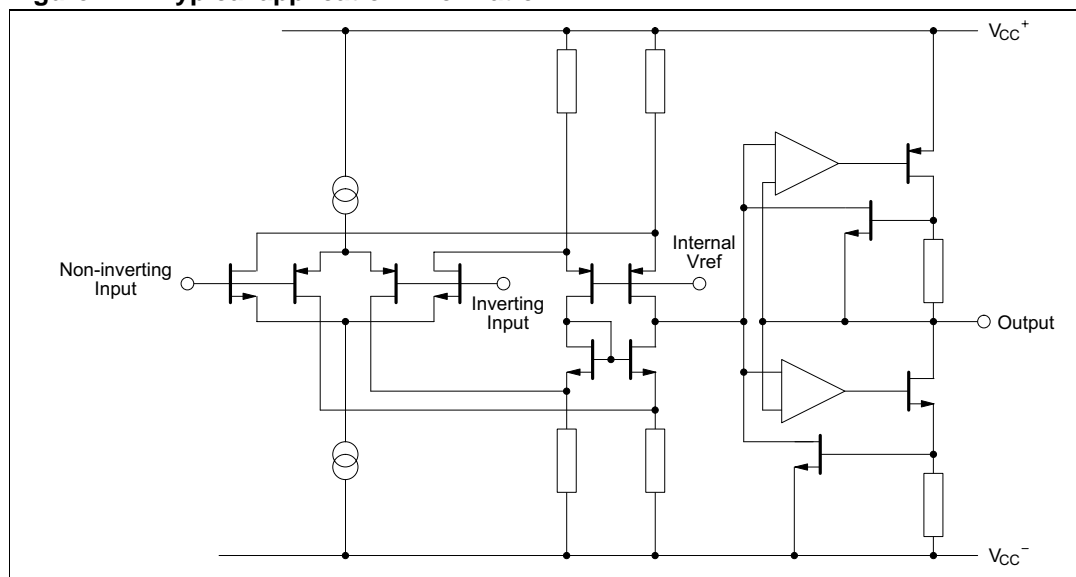

3 Electrical characteristics

Table 3. $V_{CC}^+ = 3V$, $V_{CC}^- = 0V$, R_L , C_L connected to $V_{CC}/2$, $T_{amb} = 25^\circ C$ (unless otherwise specified)

Symbol	Parameter	Test conditions	Min.	Typ.	Max.	Unit
V_{io}	Input offset voltage ($V_{icm} = V_o = V_{CC}/2$)	T_{amb} TS914 T_{amb} TS914A $T_{min} \leq T_{amb} \leq T_{max}$, TS914 $T_{min} \leq T_{amb} \leq T_{max}$, TS914A			10 5 12 7	mV
ΔV_{io}	Input offset voltage drift			5		$\mu V/^\circ C$
I_{io}	Input offset current ⁽¹⁾	T_{amb} $T_{min} \leq T_{amb} \leq T_{max}$		1	100 200	pA
I_{ib}	Input bias current ⁽¹⁾	T_{amb} $T_{min} \leq T_{amb} \leq T_{max}$		1	150 300	pA
I_{CC}	Supply current	per amplifier, $A_{VCL} = 1$, no load T_{amb} $T_{min} \leq T_{amb} \leq T_{max}$		200	300 400	μA
CMR	Common mode rejection ratio	$V_{ic} = 0$ to $3V$, $V_o = 1.5V$		70		dB
SVR	Supply voltage rejection ratio	$V_{CC}^+ = 2.7$ to $3.3V$, $V_o = V_{CC}/2$		80		dB
A_{vd}	Large signal voltage gain	$R_L = 10k\Omega$, $V_o = 1.2V$ to $1.8V$ T_{amb} $T_{min} \leq T_{amb} \leq T_{max}$	3 2	10		V/mV
V_{OH}	High level output voltage	$V_{id} = 1V$, T_{amb} $R_L = 10k\Omega$ $R_L = 600\Omega$ $R_L = 100\Omega$ $V_{id} = 1V$, $T_{min} \leq T_{amb} \leq T_{max}$ $R_L = 10k\Omega$ $R_L = 600\Omega$	2.9 2.2	2.97 2.7 2		V
V_{OL}	Low level output voltage	$V_{id} = -1V$, T_{amb} $R_L = 10k\Omega$ $R_L = 600\Omega$ $R_L = 100\Omega$ $V_{id} = -1V$, $T_{min} \leq T_{amb} \leq T_{max}$ $R_L = 10k\Omega$ $R_L = 600\Omega$		50 300 900	100 600	mV
I_o	Output short circuit current	$V_{id} = \pm 1V$ Source ($V_o = V_{CC}$) Sink ($V_o = V_{CC}^+$)		40 40		mA
GBP	Gain bandwidth product	$A_{VCL} = 100$, $R_L = 10k\Omega$, $C_L = 100pF$, $f = 100kHz$		0.8		MHz
SR	Slew rate	$A_{VCL} = 1$, $R_L = 10k\Omega$, $C_L = 100pF$, $V_i = 1.3V$ to $1.7V$		0.5		V/ μs
ϕ_m	Phase margin			30		$^\circ$
e_n	Equivalent input noise voltage	$R_s = 100\Omega$, $f = 1kHz$		30		nV/ \sqrt{Hz}
V_{O1}/V_{O2}	Channel separation	$f = 1kHz$		120		dB

1. Maximum values include unavoidable inaccuracies of the industrial tests.

Table 4. $V_{CC}^+ = 5V, V_{CC}^- = 0V, R_L, C_L$ connected to $V_{CC}/2, T_{amb} = 25^\circ C$ (unless otherwise specified)

Symbol	Parameter	Test conditions	Min.	Typ.	Max.	Unit
V_{io}	Input offset voltage ($V_{icm} = V_o = V_{CC}/2$)	$T_{amb}, TS914$ $T_{amb}, TS914A$ $T_{min} \leq T_{amb} \leq T_{max}, TS914$ $T_{min} \leq T_{amb} \leq T_{max}, TS914A$			10 5 12 7	mV
ΔV_{io}	Input offset voltage drift			5		$\mu V/^\circ C$
I_{io}	Input offset current ⁽¹⁾	T_{amb} $T_{min} \leq T_{amb} \leq T_{max}$		1	100 200	pA
I_{ib}	Input bias current ⁽¹⁾	T_{amb} $T_{min} \leq T_{amb} \leq T_{max}$		1	150 300	pA
I_{CC}	Supply current	per amplifier, $A_{VCL} = 1$, no load T_{amb} $T_{min} \leq T_{amb} \leq T_{max}$		230	350 450	μA
CMR	Common mode rejection ratio	$V_{ic} = 1.5$ to $3V, V_o = 2.5V$		85		dB
SVR	Supply voltage rejection ratio	$V_{CC}^+ = 3$ to $5V, V_o = V_{CC}/2$		80		dB
A_{vd}	Large signal voltage gain	$R_L = 10k\Omega, V_o = 1.5V$ to $3.5V$ T_{amb} $T_{min} \leq T_{amb} \leq T_{max}$	10 7	40		V/mV
V_{OH}	High level output voltage	$V_{id} = 1V, T_{amb}$ $R_L = 10k\Omega$ $R_L = 600\Omega$ $R_L = 100\Omega$ $V_{id} = 1V, T_{min} \leq T_{amb} \leq T_{max}$ $R_L = 10k\Omega$ $R_L = 600\Omega$	4.85 4.20	4.95 4.65 3.7		V
V_{OL}	Low level output voltage	$V_{id} = -1V, T_{amb}$ $R_L = 10k\Omega$ $R_L = 600\Omega$ $R_L = 100\Omega$ $V_{id} = -1V, T_{min} \leq T_{amb} \leq T_{max}$ $R_L = 10k\Omega$ $R_L = 600\Omega$		50 350 1400	100 680	mV
I_o	Output short circuit current	$V_{id} = \pm 1V$ Source ($V_o = V_{CC}$) Sink ($V_o = V_{CC}^+$)		60 60		mA
GBP	Gain bandwidth product	$A_{VCL} = 100, R_L = 10k\Omega, C_L = 100pF,$ $f = 100kHz$		1		MHz
SR	Slew rate	$A_{VCL} = 1, R_L = 10k\Omega, C_L = 100pF,$ $V_i = 1V$ to $4V$		0.8		V/ μs
ϕ_m	Phase margin			30		$^\circ$
e_n	Equivalent input noise voltage	$R_s = 100\Omega, f = 1kHz$		30		nV/ \sqrt{Hz}
V_{O1}/V_{O2}	Channel separation	$f = 1kHz$		120		dB

1. Maximum values include unavoidable inaccuracies of the industrial tests.

Table 5. $V_{CC}^+ = 10V$, $V_{DD} = 0V$, R_L , C_L connected to $V_{CC}/2$, $T_{amb} = 25^\circ C$ (unless otherwise specified)

Symbol	Parameter	Test Conditions	Min.	Typ.	Max.	Unit
V_{io}	Input offset voltage ($V_{icm} = V_o = V_{CC}/2$)	T_{amb} , TS914 T_{amb} , TS914A $T_{min} \leq T_{amb} \leq T_{max}$, TS914 $T_{min} \leq T_{amb} \leq T_{max}$, TS914A			10 5 12 7	mV
ΔV_{io}	Input offset voltage drift			5		$\mu V/^\circ C$
I_{io}	Input offset current ⁽¹⁾	T_{amb} $T_{min} \leq T_{amb} \leq T_{max}$		1	100 200	pA
I_{ib}	Input bias current ⁽¹⁾	T_{amb} $T_{min} \leq T_{amb} \leq T_{max}$		1	150 300	pA
V_{icm}	Common mode input voltage range	Per amplifier, $A_{VCL} = 1$, no load T_{amb} $T_{min} \leq T_{amb} \leq T_{max}$	$V_{DD} - 0.2$ to $V_{CC} + 0.2$			V
CMR	Common mode rejection ratio	$V_{ic} = 3$ to $7V$, $V_o = 5V$ $V_{ic} = 0$ to $10V$, $V_o = 5V$		90 75		dB
SVR	Supply voltage rejection ratio	$V_{CC}^+ = 5$ to $10V$, $V_o = V_{CC}/2$		90		dB
A_{vd}	Large signal voltage gain	$R_L = 10k\Omega$, $V_o = 2.5V$ to $7.5V$ T_{amb} $T_{min} \leq T_{amb} \leq T_{max}$	15 10	60		V/mV
V_{OH}	High level output voltage	$V_{id} = 1V$, T_{amb} $R_L = 10k\Omega$ $R_L = 600\Omega$ $R_L = 100\Omega$ $V_{id} = 1V$, $T_{min} \leq T_{amb} \leq T_{max}$ $R_L = 10k\Omega$ $R_L = 600\Omega$	9.85 9 9.8 9	9.95 9.35 7.8		V
V_{OL}	Low level output voltage	$V_{id} = -1V$, T_{amb} $R_L = 10k\Omega$ $R_L = 600\Omega$ $R_L = 100\Omega$ $V_{id} = -1V$, $T_{min} \leq T_{amb} \leq T_{max}$ $R_L = 10k\Omega$ $R_L = 600\Omega$		50 650 2300	180 800	mV
I_o	Output short circuit current	$V_{id} = \pm 1V$		60		mA
I_{CC}	Supply current	Per amplifier, $A_{VCL} = 1$, no load, T_{amb} Per amp., $A_{VCL} = 1$, no load, $T_{min} \leq T_{amb} \leq T_{max}$		400	600 700	μA
GBP	Gain bandwidth product	$A_{VCL} = 100$, $R_L = 10k\Omega$, $C_L = 100pF$, $f = 100kHz$		1.4		MHz
SR	Slew rate	$A_{VCL} = 1$, $R_L = 10k\Omega$, $C_L = 100pF$, $V_i = 2.5V$ to $7.5V$		1		V/ μs
ϕ_m	Phase margin	$R_s = 100\Omega$, $f = 1kHz$		40		$^\circ$
e_n	Equivalent input noise voltage	$R_s = 100\Omega$, $f = 1kHz$		30		nV/ \sqrt{Hz}

Table 5. $V_{CC^+} = 10V$, $V_{DD} = 0V$, R_L , C_L connected to $V_{CC}/2$, $T_{amb} = 25^{\circ}C$ (unless otherwise specified)

Symbol	Parameter	Test Conditions	Min.	Typ.	Max.	Unit
THD	Total harmonic distortion	$A_{VCL} = 1$, $R_L = 10k\Omega$, $C_L = 100pF$, $V_o = 4.75$ to $5.25V$, $f = 1kHz$		0.02		%
C_{in}	Input capacitance			1.5		pF
R_{in}	Input resistance			>10		Tera Ω
V_{O1}/V_{O2}	Channel separation	$f = 1kHz$		120		dB

1. Maximum values include unavoidable inaccuracies of the industrial tests.

Figure 2. Supply current (each amplifier) vs. supply voltage

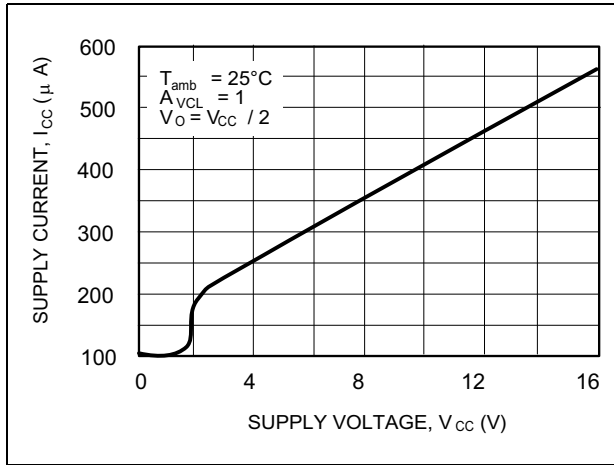

Figure 3. High level output voltage vs. high level output current

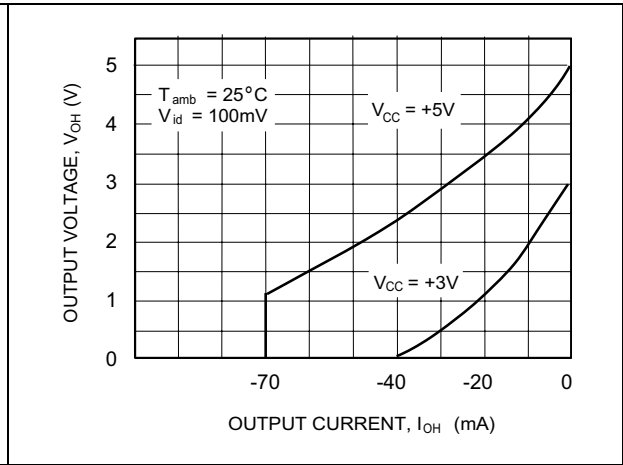

Figure 4. Low level output voltage vs. low level output current

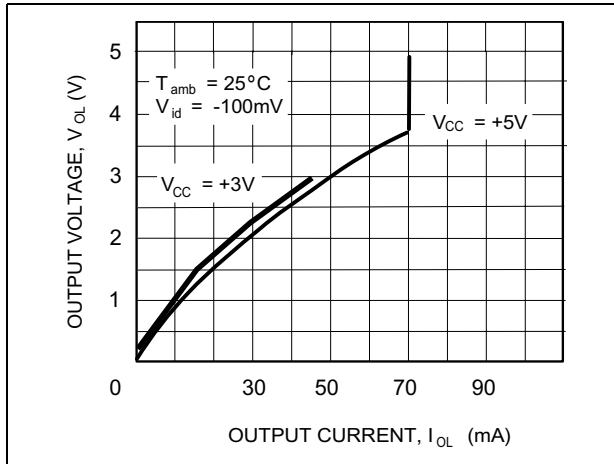

Figure 5. Input bias current vs. temperature

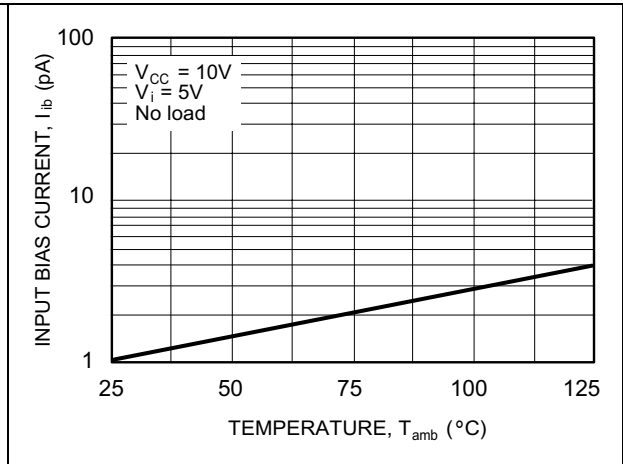

Figure 6. High level output voltage vs. high level output current

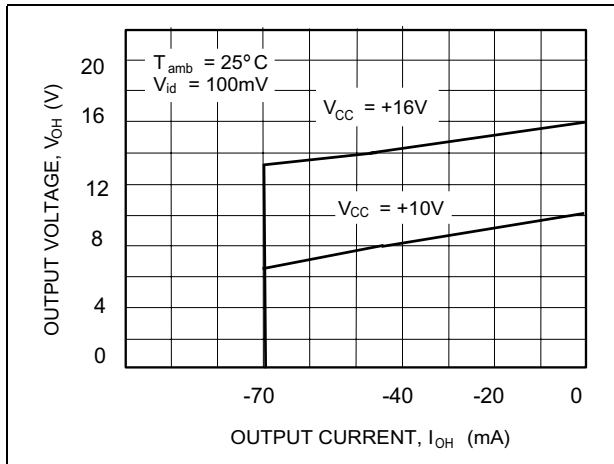

Figure 7. Low level output voltage vs. low level output current

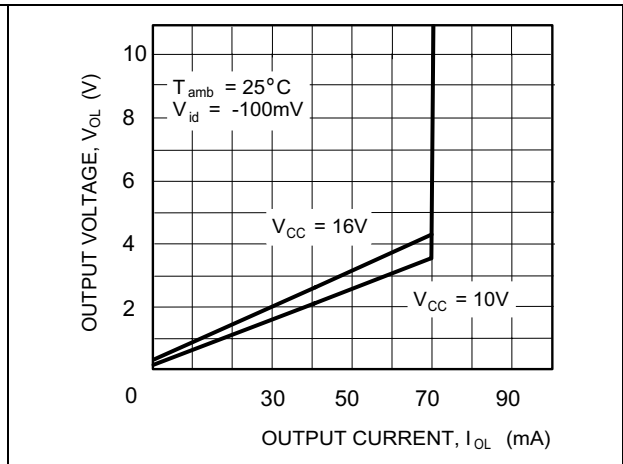

Figure 8. Gain and phase vs. frequency

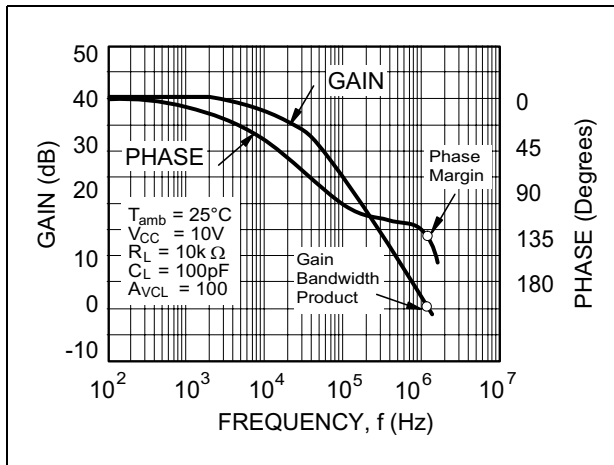

Figure 9. Gain bandwidth product vs. supply voltage

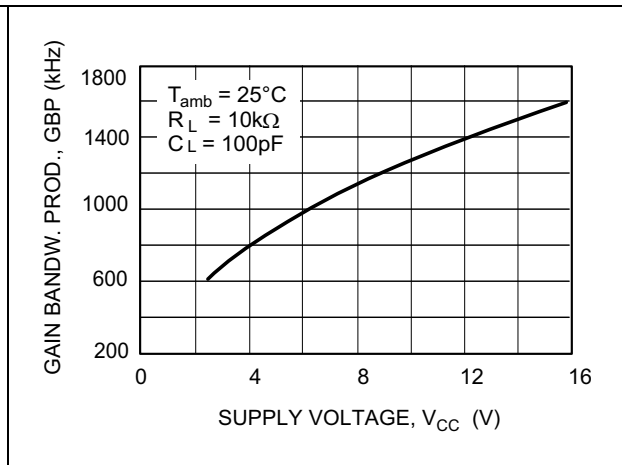

Figure 10. Phase margin vs. supply voltage

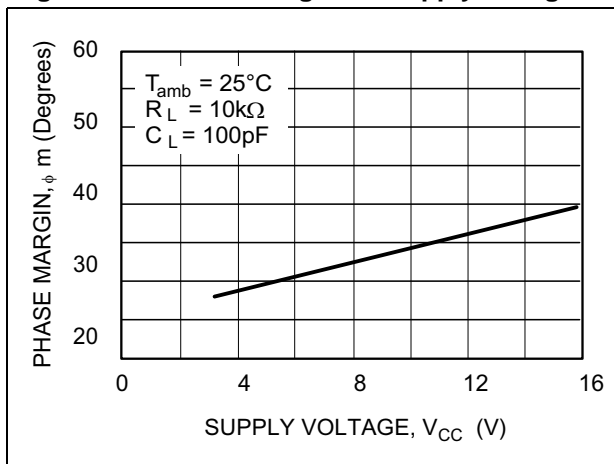

Figure 11. Gain and phase vs. frequency

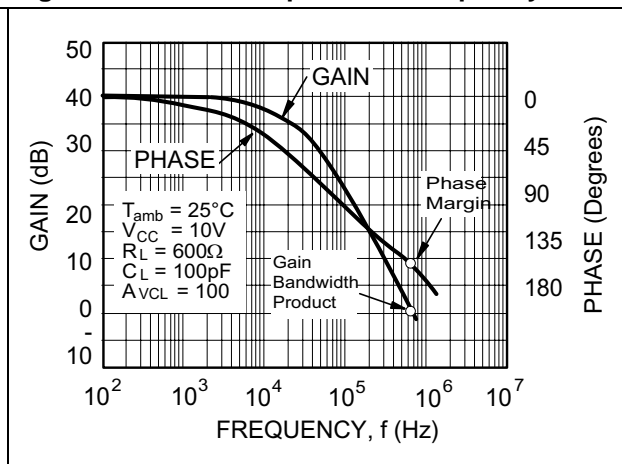

Figure 12. Gain bandwidth product vs. supply voltage

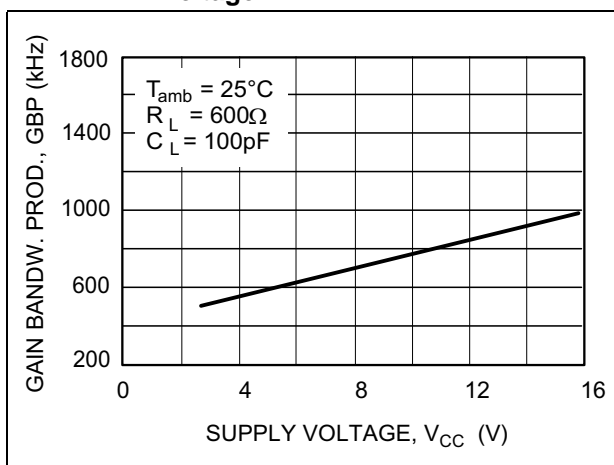

Figure 13. Phase margin vs. supply voltage

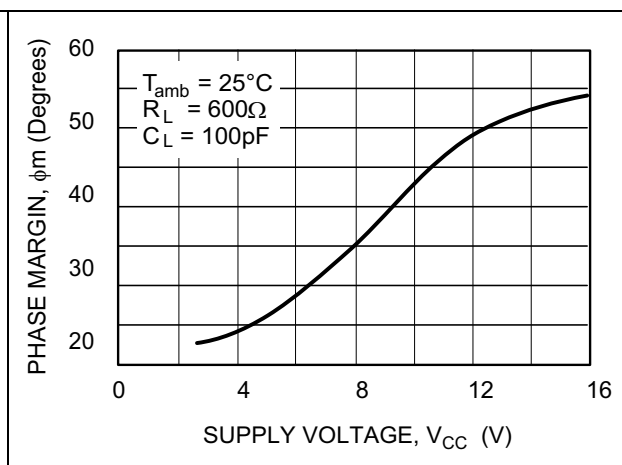
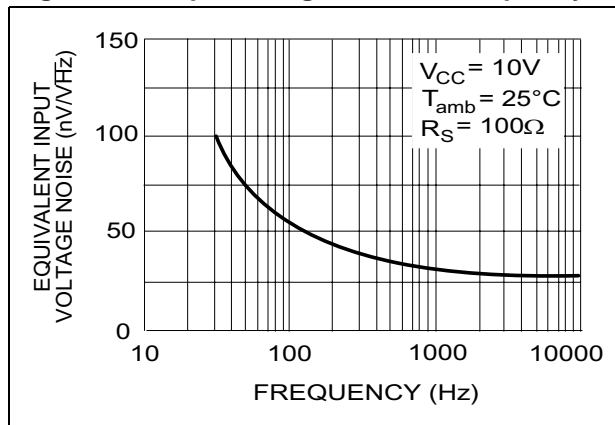

Figure 14. Input voltage noise vs. frequency

4 Macromodels

4.1 Important note concerning this macromodel

Please consider the following remarks before using this macromodel:

- All models are a trade-off between accuracy and complexity (i.e. simulation time). Macromodels are not a substitute for breadboarding; rather, they confirm the validity of a design approach and help to select surrounding component values.
- A macromodel emulates the **nominal** performance of a **typical** device within **specified operating conditions** (such as temperature or supply voltage, etc). Thus, the macromodel is often not as exhaustive as the datasheet, its purpose is to illustrate the main parameters of the product.
- Data derived from macromodels used outside of the specified conditions (such as V_{CC} , or temperature) or even worse, outside of the device's operating conditions (such as V_{CC} or V_{icm}) is not reliable in any way.

The values provided in [Table 6](#) are derived from this macromodel.

Table 6. $V_{CC}^+ = 3V$, $V_{CC}^- = 0V$, R_L , C_L connected to $V_{CC}/2$, $T_{amb} = 25^\circ C$ (unless otherwise specified)

Symbol	Conditions	Value	Unit
V_{io}		0	mV
A_{vd}	$R_L = 10k\Omega$	10	V/mV
I_{CC}	No load, per operator	100	μA
V_{icm}		-0.2 to 3.2	V
V_{OH}	$R_L = 600\Omega$	2.96	V
V_{OL}	$R_L = 60\Omega$	300	mV
I_{sink}	$V_O = 3V$	40	mA
I_{source}	$V_O = 0V$	40	mA
GBP	$R_L = 10k\Omega$, $C_L = 100pF$	0.8	MHz
SR	$R_L = 10k\Omega$, $C_L = 100pF$	0.3	V/ μs
ϕ_m	Phase margin	30	Degrees

4.2 Macromodel code

```

* Standard Linear Ics Macromodels, 1993.
** CONNECTIONS :
* 1 INVERTING INPUT
* 2 NON-INVERTING INPUT
* 3 OUTPUT
* 4 POSITIVE POWER SUPPLY
* 5 NEGATIVE POWER SUPPLY
*
.SUBCKT TS914 1 2 3 4 5
*****
.MODEL MDTH D IS=1E-8 KF=6.564344E-14 CJO=10F
CIP 2 5 1.000000E-12
CIN 1 5 1.000000E-12
EIP 10 5 2 5 1
EIN 16 5 1 5 1
RIP 10 11 6.500000E+00
RIN 15 16 6.500000E+00
RIS 11 15 7.322092E+00
DIP 11 12 MDTH 400E-12
DIN 15 14 MDTH 400E-12
VOFP 12 13 DC 0.000000E+00
VOFN 13 14 DC 0
IPOL 13 5 4.000000E-05
CPS 11 15 2.498970E-08
DINN 17 13 MDTH 400E-12
VIN 17 5 0.000000E+00
DINR 15 18 MDTH 400E-12
VIP 4 18 0.000000E+00
FCP 4 5 VOFP 5.750000E+00
FCN 5 4 VOFN 5.750000E+00
* AMPLIFYING STAGE
FIP 5 19 VOFP 4.400000E+02
FIN 5 19 VOFN 4.400000E+02
RG1 19 5 4.904961E+05
RG2 19 4 4.904961E+05
CC 19 29 2.200000E-08
HZTP 30 29 VOFP 1.8E+03
HZTN 5 30 VOFN 1.8E+03
DOPM 19 22 MDTH 400E-12
DONM 21 19 MDTH 400E-12
HOPM 22 28 VOUT 3800
VIPM 28 4 230
HONM 21 27 VOUT 3800
VINM 5 27 230
EOUT 26 23 19 5 1
VOUT 23 5 0
ROUT 26 3 82
COUT 3 5 1.000000E-12
DOP 19 68 MDTH 400E-12
VOP 4 25 1.724

```

```
HSCP 68 25 VSCP1 0.8E+8
DON 69 19 MDTH 400E-12
VON 24 5 1.7419107
HSCN 24 69 VSCN1 0.8E+8
VSCTHP 60 61 0.0875
DSCP1 61 63 MDTH 400E-12
VSCP1 63 64 0
ISCP 64 0 1.000000E-8
DSCP2 0 64 MDTH 400E-12
DSCN2 0 74 MDTH 400E-12
ISCN 74 0 1.000000E-8
VSCN1 73 74 0
DSCN1 71 73 MDTH 400E-12
VSCTHN 71 70 -0.55
ESCP 60 0 2 1 500
ESCN 70 0 2 1 -2000
.ENDS
```

5 Package mechanical data

In order to meet environmental requirements, STMicroelectronics offers these devices in ECOPACK[®] packages. These packages have a lead-free second level interconnect. The category of second level interconnect is marked on the package and on the inner box label, in compliance with JEDEC Standard JESD97. The maximum ratings related to soldering conditions are also marked on the inner box label. ECOPACK is an STMicroelectronics trademark. ECOPACK specifications are available at: www.st.com.

5.1 DIP-14 package

Ref.	Dimensions					
	Millimeters			Inches		
	Min.	Typ.	Max.	Min.	Typ.	Max.
a1	0.51			0.020		
B	1.39		1.65	0.055		0.065
b		0.5			0.020	
b1		0.25			0.010	
D			20			0.787
E		8.5			0.335	
e		2.54			0.100	
e3		15.24			0.600	
F			7.1			0.280
l			5.1			0.201
L		3.3			0.130	
Z	1.27		2.54	0.050		0.100

The figure contains three mechanical drawings of the DIP-14 package. The top drawing is a perspective view showing the package with its leads. Dimensions labeled include: a1 (lead height), B (lead pitch), b (lead thickness), b1 (lead width), e (lead spacing), e3 (total lead length), F (package height), l (lead length), and Z (lead diameter). The middle drawing is a side view showing the package width E and lead width b1. The bottom drawing is a top-down view showing the package length D and height F, with pin numbers 1, 7, 8, and 14 indicated.

5.2 SO-14 package

Ref.	Dimensions					
	Millimeters			Inches		
	Min.	Typ.	Max.	Min.	Typ.	Max.
A			1.75			0.068
a1	0.1		0.2	0.003		0.007
a2			1.65			0.064
b	0.35		0.46	0.013		0.018
b1	0.19		0.25	0.007		0.010
C		0.5			0.019	
c1	45° (typ.)					
D	8.55		8.75	0.336		0.344
E	5.8		6.2	0.228		0.244
e		1.27			0.050	
e3		7.62			0.300	
F	3.8		4.0	0.149		0.157
G	4.6		5.3	0.181		0.208
L	0.5		1.27	0.019		0.050
M			0.68			0.026
S	8° (max.)					

The image contains three mechanical drawings of the SO-14 package:

- Top View:** Shows the package footprint with dimensions D (total length), M (lead length), and F (width). Pin numbers 1, 7, 8, and 14 are indicated.
- Side View:** Shows the package height with dimensions A (total height), a2 (lead height), e (lead thickness), and b (lead width).
- Perspective View:** Shows the package with dimensions L (lead length), G (lead width), C (lead thickness), c1 (lead angle), E (package length), a1 (lead thickness), and b1 (lead width).

6 Revision history

Date	Revision	Changes
1-Dec-2001	1	First release.
1-Nov-2004	2	V_{io} max on 1st page from 2mV to 5mV.
1-Jun-2005	3	PIPAP references inserted in the datasheet see order code table on cover page.
1-Feb-2006	4	Parameters added in Table 1. on page 3 (T_j , ESD, R_{thja} , R_{thjc}).
8-Jan-2007	5	Correction to package name in order code table on cover page. Addition of a table of contents. Corrections to macromodel.

Please Read Carefully:

Information in this document is provided solely in connection with ST products. STMicroelectronics NV and its subsidiaries ("ST") reserve the right to make changes, corrections, modifications or improvements, to this document, and the products and services described herein at any time, without notice.

All ST products are sold pursuant to ST's terms and conditions of sale.

Purchasers are solely responsible for the choice, selection and use of the ST products and services described herein, and ST assumes no liability whatsoever relating to the choice, selection or use of the ST products and services described herein.

No license, express or implied, by estoppel or otherwise, to any intellectual property rights is granted under this document. If any part of this document refers to any third party products or services it shall not be deemed a license grant by ST for the use of such third party products or services, or any intellectual property contained therein or considered as a warranty covering the use in any manner whatsoever of such third party products or services or any intellectual property contained therein.

UNLESS OTHERWISE SET FORTH IN ST'S TERMS AND CONDITIONS OF SALE ST DISCLAIMS ANY EXPRESS OR IMPLIED WARRANTY WITH RESPECT TO THE USE AND/OR SALE OF ST PRODUCTS INCLUDING WITHOUT LIMITATION IMPLIED WARRANTIES OF MERCHANTABILITY, FITNESS FOR A PARTICULAR PURPOSE (AND THEIR EQUIVALENTS UNDER THE LAWS OF ANY JURISDICTION), OR INFRINGEMENT OF ANY PATENT, COPYRIGHT OR OTHER INTELLECTUAL PROPERTY RIGHT.

UNLESS EXPRESSLY APPROVED IN WRITING BY AN AUTHORIZED ST REPRESENTATIVE, ST PRODUCTS ARE NOT RECOMMENDED, AUTHORIZED OR WARRANTED FOR USE IN MILITARY, AIR CRAFT, SPACE, LIFE SAVING, OR LIFE SUSTAINING APPLICATIONS, NOR IN PRODUCTS OR SYSTEMS WHERE FAILURE OR MALFUNCTION MAY RESULT IN PERSONAL INJURY, DEATH, OR SEVERE PROPERTY OR ENVIRONMENTAL DAMAGE. ST PRODUCTS WHICH ARE NOT SPECIFIED AS "AUTOMOTIVE GRADE" MAY ONLY BE USED IN AUTOMOTIVE APPLICATIONS AT USER'S OWN RISK.

Resale of ST products with provisions different from the statements and/or technical features set forth in this document shall immediately void any warranty granted by ST for the ST product or service described herein and shall not create or extend in any manner whatsoever, any liability of ST.

ST and the ST logo are trademarks or registered trademarks of ST in various countries.

Information in this document supersedes and replaces all information previously supplied.

The ST logo is a registered trademark of STMicroelectronics. All other names are the property of their respective owners.

© 2007 STMicroelectronics - All rights reserved

STMicroelectronics group of companies

Australia - Belgium - Brazil - Canada - China - Czech Republic - Finland - France - Germany - Hong Kong - India - Israel - Italy - Japan - Malaysia - Malta - Morocco - Singapore - Spain - Sweden - Switzerland - United Kingdom - United States of America

www.st.com