

UG8FT AND UG8GT

ULTRAFAST SOFT RECOVERY RECTIFIER

Reverse Voltage - 300 to 400 Volts Forward Current - 8.0 Amperes

TO-220AC

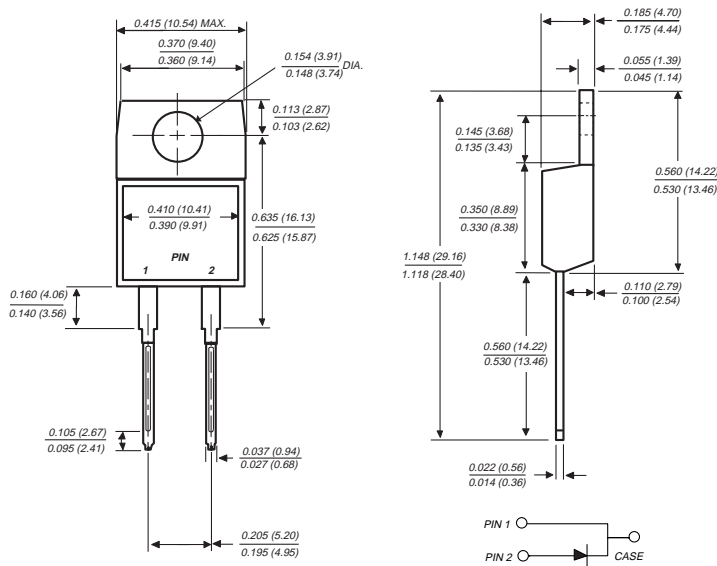

FEATURES

- ◆ Plastic package has Underwriters Laboratories Flammability Classification 94V-0
- ◆ Ideally suited for freewheeling diode power factor correction applications
- ◆ Soft recovery characteristics
- ◆ Excellent high temperature switching
- ◆ Optimized to reduce switching losses
- ◆ High temperature soldering in accordance with CECC 802 / Reflow guaranteed
- ◆ Glass passivated chip junction

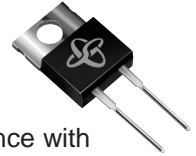

MECHANICAL DATA

Case: JEDEC TO-220AC molded plastic body

Terminals: Plated leads, solderable per MIL-STD-750, Method 2026

Polarity: As marked

Mounting Position: Any

Weight: 0.08 ounce, 2.24 grams

MAXIMUM RATINGS AND ELECTRICAL CHARACTERISTICS

Ratings at 25°C ambient temperature unless otherwise specified.

	SYMBOLS	UG8FT	UG8GT	UNITS
Maximum repetitive peak reverse voltage	V_{RRM}	300	400	Volts
Working peak reverse voltage	V_{RWM}	225	300	Volts
Maximum RMS voltage	V_{RMS}	210	280	Volts
Maximum DC blocking voltage	V_{DC}	300	400	Volts
Maximum average forward rectified current at $T_C=100^\circ\text{C}$	$I_{(AV)}$	8.0		Amps
Peak forward surge current 8.3ms single half sine-wave superimposed on rated load (JEDEC Method)	I_{FSM}	100.0		Amps
Maximum instantaneous forward voltage at $I_F=8\text{A}$ (NOTE 1)	V_F	1.30	1.00	Volts
		$T_J=25^\circ\text{C}$	$T_J=150^\circ\text{C}$	
Maximum reverse leakage current at working peak reverse voltage	I_R	10	350	μA
		$T_C=25^\circ\text{C}$	$T_C=100^\circ\text{C}$	
Maximum reverse recovery time at $I_F=0.5\text{A}$, $I_R=1.0\text{A}$, $I_{rr}=0.25\text{A}$	t_{rr}	35		ns
Maximum Reverse recovery time at $I_F=1.0\text{A}$, $di/dt=100\text{A}/\mu\text{s}$, $V_R=30\text{V}$, $I_{rr}=0.1 I_{RM}$	t_{rr}	50		ns
Maximum reverse recovery current at $I_F=10\text{A}$, $di/dt=50\text{A}/\mu\text{s}$, $V_R=30\text{V}$	I_{RM}	5.5		Amps
		$T_C=100^\circ\text{C}$		
Maximum stored charge $I_F=2\text{A}$, $di/dt=20\text{A}/\mu\text{s}$, $V_R=30\text{V}$, $I_{rr}=0.1 I_{RM}$	Q_{rr}	55		nC
Typical thermal resistance from junction to case	$R_{\theta JC}$	2.2		$^\circ\text{C}/\text{W}$
Operating junction and storage temperature range	T_J, T_{STG}	-40 to +150		$^\circ\text{C}$

NOTE: (1) Pulse test: 300 μs pulse width, 1% duty cycle

NOTICE: Advanced product information is subject to change without notice

RATINGS AND CHARACTERISTIC CURVES UG8FT AND UG8GT

FIG. 1 - FORWARD CURRENT DERATING CURVE

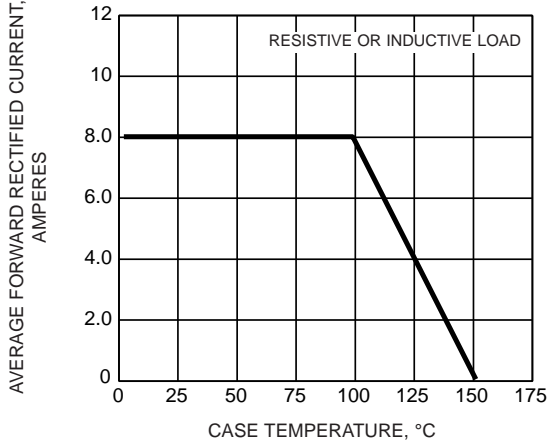

FIG. 2 - MAXIMUM NON-REPETITIVE PEAK FORWARD SURGE CURRENT

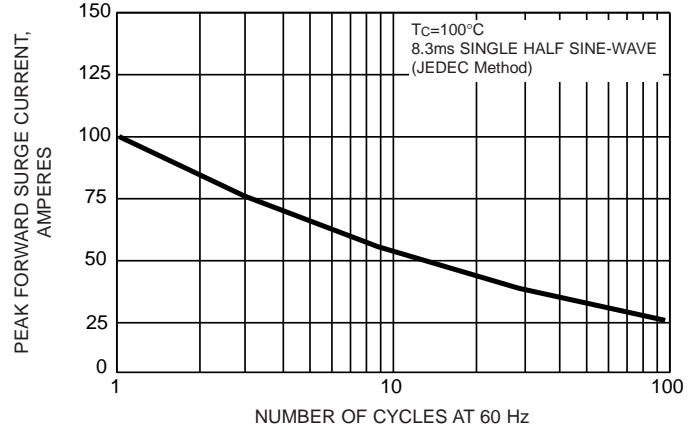

FIG. 3 - TYPICAL INSTANTANEOUS FORWARD CHARACTERISTICS

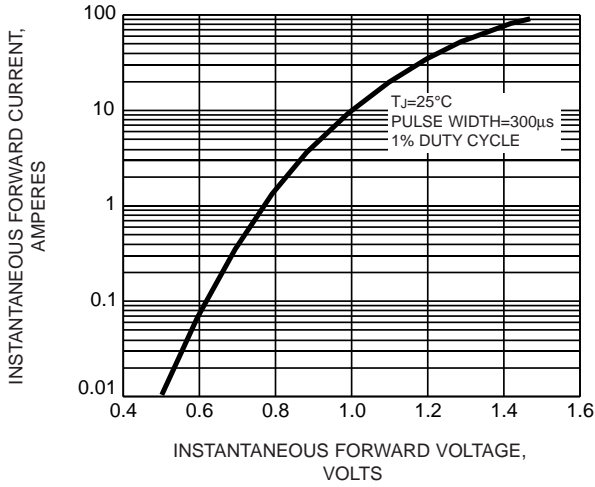

FIG. 4 - TYPICAL REVERSE CHARACTERISTICS

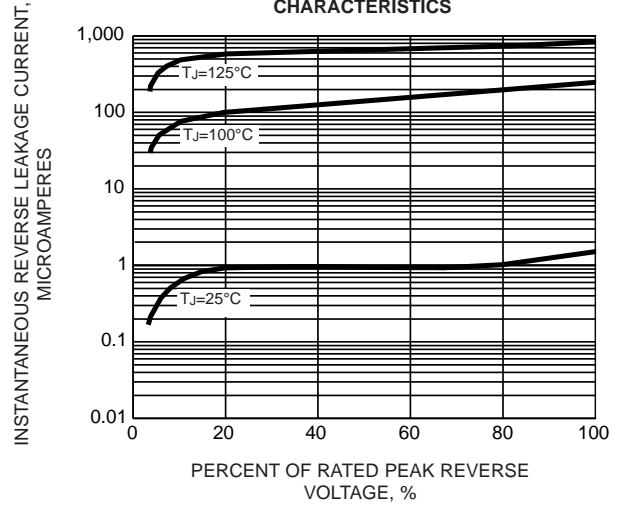

FIG. 5 - REVERSE SWITCHING CHARACTERISTICS

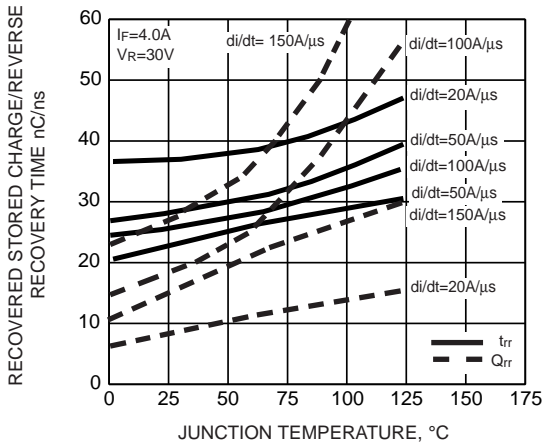

FIG. 6 - TYPICAL JUNCTION CAPACITANCE

