

SEMITOP® 3

IGBT Module

SK60GB128

Preliminary Data

Features

- Compact design
- One screw mounting
- Heat transfer and isolation through direct copper bonded aluminium oxide ceramic (DCB)
- High short circuit capability
- SPT= Soft-Punch-Through technology
- $V_{ce,sat}$ with positive coefficient

Typical Applications

- Switching (not for linear use)
- Inverter
- Switched mode power supplies
- UPS

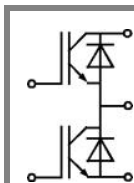

GB

Absolute Maximum Ratings		$T_s = 25\text{ °C}$, unless otherwise specified		
Symbol	Conditions	Values		Units
IGBT				
V_{CES}	$T_j = 25\text{ °C}$	1200		V
I_C	$T_j = 125\text{ °C}$	$T_s = 25\text{ °C}$	63	A
		$T_s = 80\text{ °C}$	44	A
I_{CRM}	$I_{CRM} = 2 \times I_{Cnom}$	100		A
V_{GES}		± 20		V
t_{psc}	$V_{CC} = 600\text{ V}; V_{GE} \leq 20\text{ V}; T_j = 125\text{ °C}$ $V_{CES} < 1200\text{ V}$	10		µs
Inverse Diode				
I_F	$T_j = 150\text{ °C}$	$T_s = 25\text{ °C}$	57	A
		$T_s = 80\text{ °C}$	38	A
I_{FRM}	$I_{FRM} = 2 \times I_{Fnom}$			A
I_{FSM}	$t_p = 10\text{ ms}; \text{half sine wave } T_j = 150\text{ °C}$	550		A
Module				
$I_{t(RMS)}$				A
T_{vj}		-40 ... +150		°C
T_{stg}		-40 ... +125		°C
V_{isol}	AC, 1 min.	2500		V

Characteristics		$T_s = 25\text{ °C}$, unless otherwise specified				
Symbol	Conditions	min.	typ.	max.	Units	
IGBT						
$V_{GE(th)}$	$V_{GE} = V_{CE}, I_C = 2\text{ mA}$	4,5	5,5	6,5	V	
I_{CES}	$V_{GE} = 0\text{ V}, V_{CE} = V_{CES}$	$T_j = 25\text{ °C}$		0,1	mA	
		$T_j = 125\text{ °C}$		0,2	mA	
I_{GES}	$V_{CE} = 0\text{ V}, V_{GE} = 20\text{ V}$	$T_j = 25\text{ °C}$		200	nA	
		$T_j = 125\text{ °C}$			nA	
V_{CE0}		$T_j = 25\text{ °C}$	1,1	1,3	V	
		$T_j = 125\text{ °C}$	1	1,2	V	
r_{CE}	$V_{GE} = 15\text{ V}$	$T_j = 25\text{ °C}$	16		mΩ	
		$T_j = 125\text{ °C}$	18		mΩ	
$V_{CE(sat)}$	$I_{Cnom} = 50\text{ A}, V_{GE} = 15\text{ V}$	$T_j = 25\text{ °C}_{chiplev.}$	1,7	1,9	2,3	V
		$T_j = 125\text{ °C}_{chiplev.}$		1,9	2,3	V
C_{ies}	$V_{CE} = 25, V_{GE} = 0\text{ V}$	$f = 1\text{ MHz}$	4,46		nF	
C_{oes}			0,33		nF	
C_{res}			0,21		nF	
$t_{d(on)}$	$R_{Gon} = 15\text{ } \Omega$	$V_{CC} = 600\text{ V}$ $I_{Cnom} = 50\text{ A}$	80		ns	
t_r			50		ns	
E_{on}	$R_{Goff} = 15\text{ } \Omega$	$T_j = 125\text{ °C}$ $V_{GE} = \pm 15\text{ V}$	5,8		mJ	
$t_{d(off)}$			420		ns	
t_f			40		ns	
E_{off}			4,8		mJ	
$R_{th(j-s)}$	per IGBT			0,6	K/W	

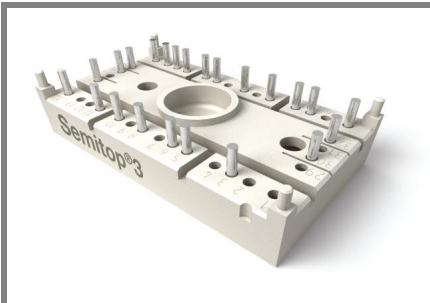

SEMITOP[®] 3

IGBT Module

SK60GB128

Preliminary Data

Features

- Compact design
- One screw mounting
- Heat transfer and isolation through direct copper bonded aluminium oxide ceramic (DCB)
- High short circuit capability
- SPT= Soft-Punch-Through technology
- $V_{ce,sat}$ with positive coefficient

Typical Applications

- Switching (not for linear use)
- Inverter
- Switched mode power supplies
- UPS



GB

Characteristics

Symbol	Conditions	min.	typ.	max.	Units
Inverse Diode					
$V_F = V_{EC}$	$I_{Fnom} = 50 \text{ A}; V_{GE} = 0 \text{ V}$	$T_j = 25 \text{ }^\circ\text{C}_{chiplev.}$	2	2,5	V
		$T_j = 125 \text{ }^\circ\text{C}_{chiplev.}$	1,8	2,3	V
V_{F0}			1	1,2	V
r_F			18	22	m Ω
I_{RRM}	$I_{Fnom} = 50 \text{ A}$		40		A
Q_{rr}	$di/dt = -800 \text{ A}/\mu\text{s}$		8		μC
E_{rr}	$V_{CC} = 600\text{V}$		2		mJ
$R_{th(j-s)D}$	per diode			0,9	K/W
M_s	to heat sink M1	2,25		2,5	Nm
w			29		g

This is an electrostatic discharge sensitive device (ESDS), international standard IEC 60747-1, Chapter IX.

This technical information specifies semiconductor devices but promises no characteristics. No warranty or guarantee expressed or implied is made regarding delivery, performance or suitability.

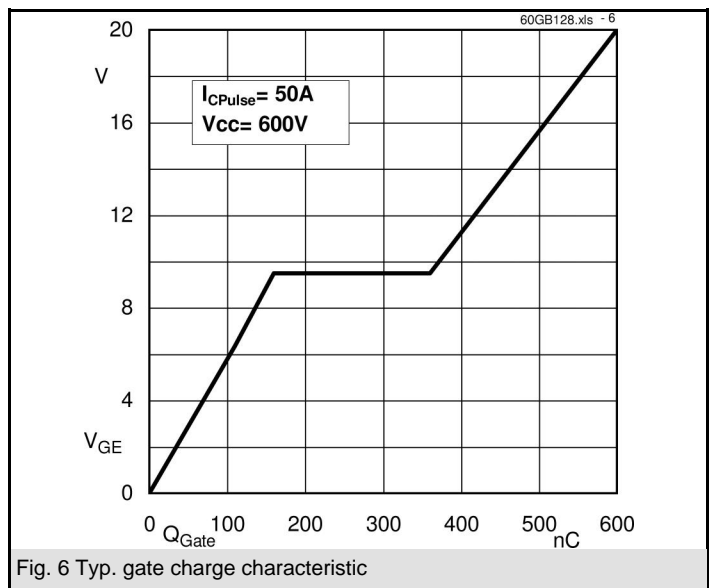
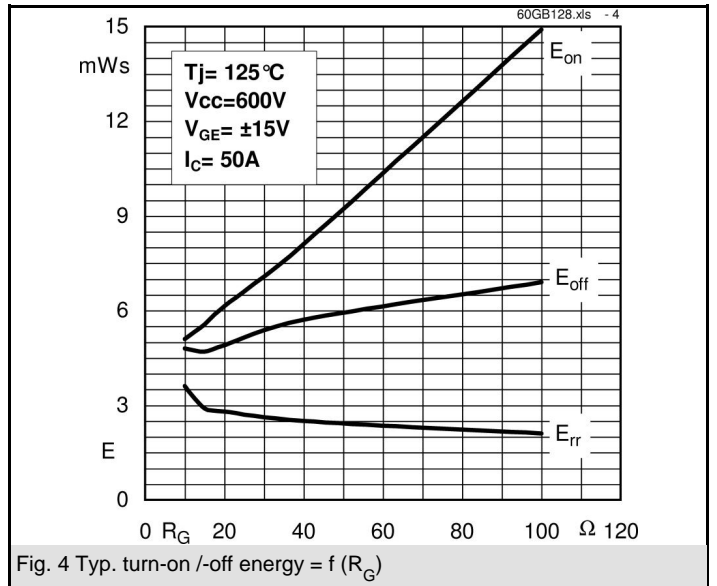
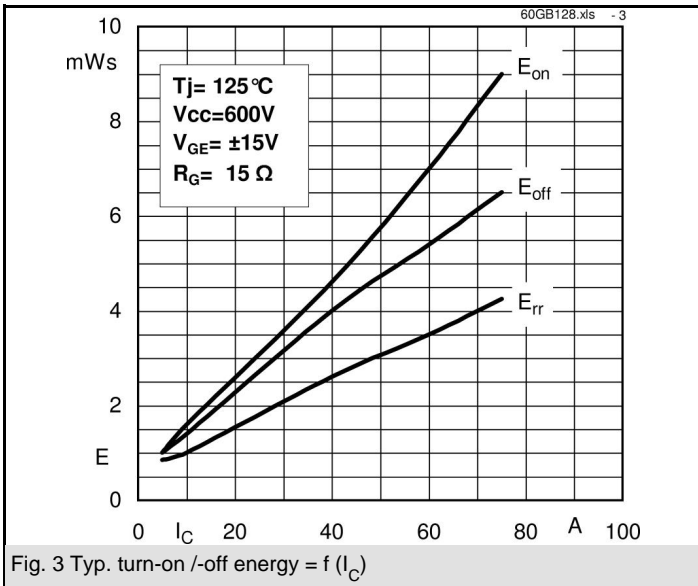
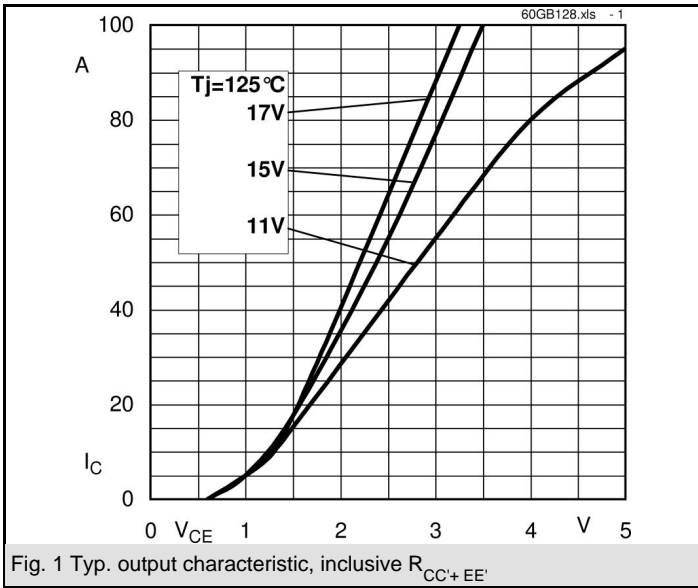

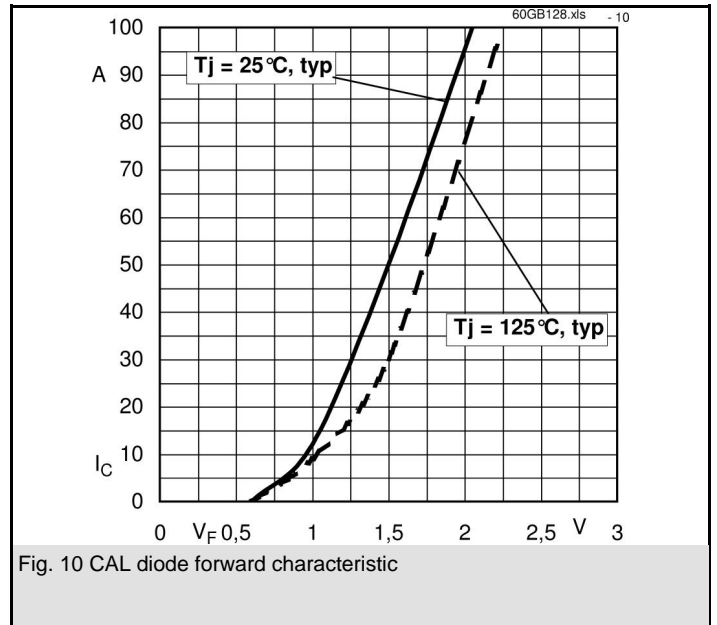
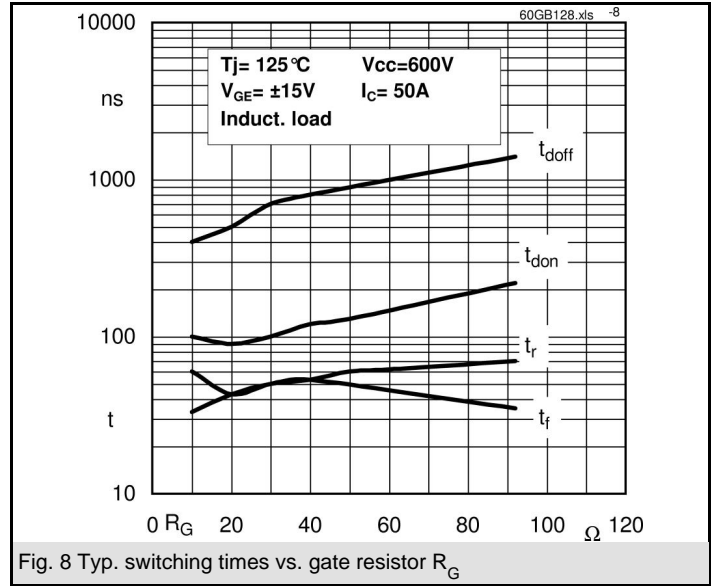
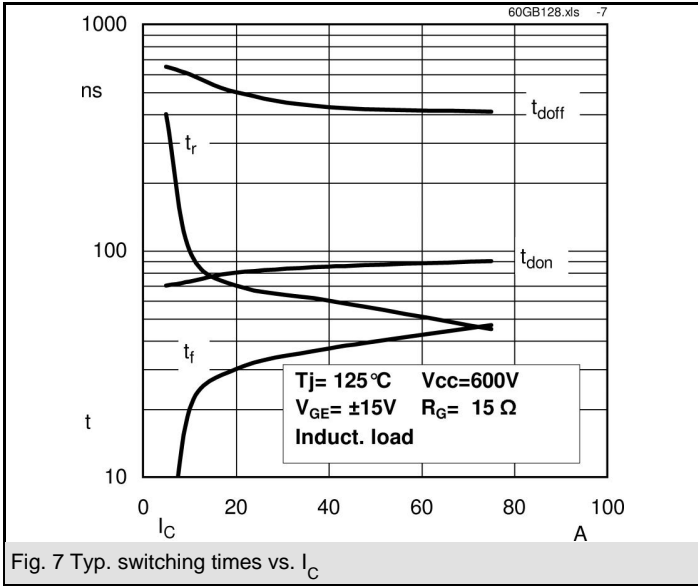

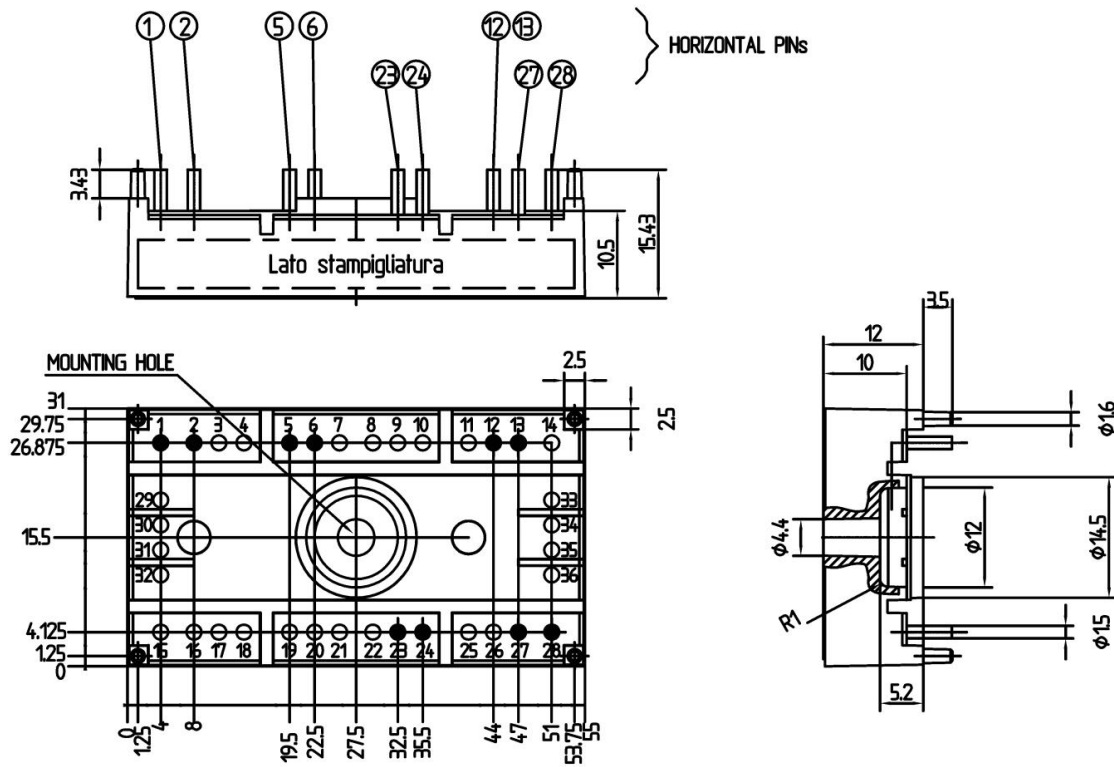

Case T27 (Suggested hole diameter, in the PCB, for solder pins and plastic mounting pins: 2mm)

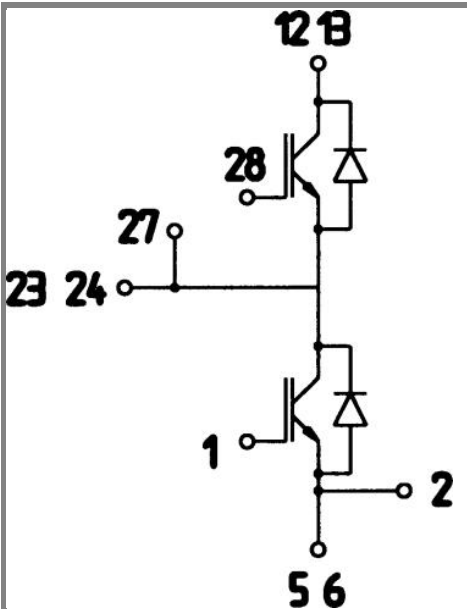

Case T27

GB