



## DESCRIPTION

- 9.9mm (0.39") Single digit numeric display series.
- Standard brightness.
- Low current operation.
- Excellent character appearance.
- Easy mounting on P.C.boards or sockets

## Package Dimensions & Internal Circuit Diagram

FYS-3914 Series

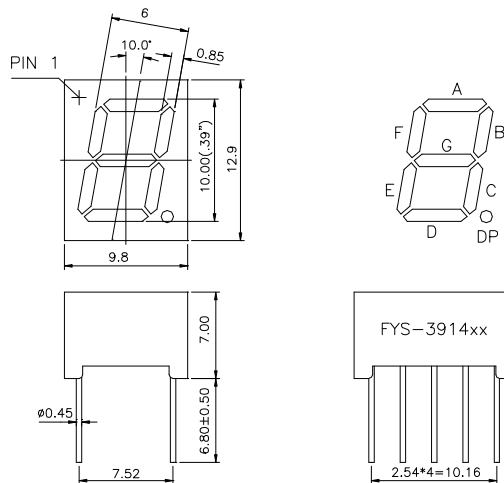

FYS-3914Ax

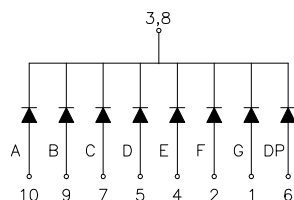

FYS-3914Bx

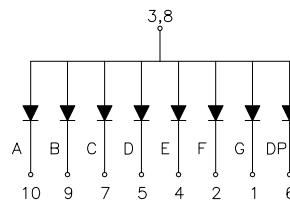

### Notes:

- All dimensions are in millimeters (inches)
- Tolerance is  $\pm 0.25(0.01)$  unless otherwise noted.
- Specifications are subject to change without notice.



**PartNO.: FYS-3914AX/BX-XX**

: Absolute maximum ratings (Ta=25°C)

| Parameter             | Symbol | Test Condition      | Value |       | Unit |
|-----------------------|--------|---------------------|-------|-------|------|
|                       |        |                     | Min   | Max   |      |
| Reverse Voltage       | VR     | IR=30μA             | 5     | ----- | V    |
| Forward Current       | IF     | -----               | ----- | 30    | mA   |
| Power Dissipation     | Pd     | -----               | ----- | 100   | mW   |
| Pulse Current         | Ipeak  | Duty=0.1mS,<br>1KHz | ----- | 150   | mA   |
| Operating Temperature | Topr   | -----               | -40   | +85   | ° C  |
| Storage Temperature   | Tstr   | -----               | -40   | +85   | ° C  |

■ **Description:**

• Color Code & Chip characteristics: (Test Condition: IF=20mA)

| Emitting Color |           | Dice Material       | Peak Wave Length (λp) | Spectral Line halfwidth(Δλ1/2) | Forward Voltage(VF) Unit:V |      | Luminous Intensity (lv) Unit:ucd |
|----------------|-----------|---------------------|-----------------------|--------------------------------|----------------------------|------|----------------------------------|
|                |           |                     |                       |                                | Typ                        | Max  |                                  |
| H              | Red       | GaP/GaP             | 700nm                 | 90nm                           | 2.25                       | 2.50 | 500                              |
| S              | Hi Red    | GaAlAs/GaAs,SH      | 660nm                 | 20nm                           | 1.85                       | 2.20 | 3500                             |
| D              | Super Red | GaAlAs/GaAs,DH      | 660nm                 | 20nm                           | 1.85                       | 2.20 | 6000                             |
| UR             | Ultra Red | GaAlAs/GaAs,DD<br>H | 660nm                 | 20nm                           | 1.85                       | 2.20 | 12000                            |
| E              | Orange    | GaAsP/GaP           | 635nm                 | 35nm                           | 2.10                       | 2.50 | 2500                             |
| Y              | Yellow    | GaAsP/GaP           | 585nm                 | 35nm                           | 2.10                       | 2.50 | 2000                             |
| G              | Green     | GaP/GaP             | 570nm                 | 30nm                           | 2.20                       | 2.50 | 2500                             |

• -XX: Surface / Lens color:

| Number            | 0           | 1              | 2            | 3              | 4               | 5 |
|-------------------|-------------|----------------|--------------|----------------|-----------------|---|
| Ref Surface Color | White       | Black          | Gray         | Red            | Green           |   |
| Epoxy Color       | Water clear | White diffused | Red Diffused | Green Diffused | Yellow Diffused |   |



**PartNO.: FYS-3914AX/BX-XX**

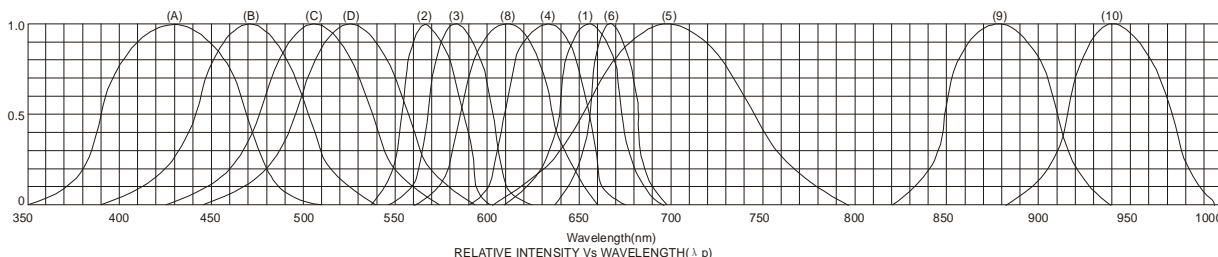

- |   |                                      |
|---|--------------------------------------|
| (1) - GaAsP/GaAs 655nm/Red                | (9) - GaAlAs 880nm                   |
| (2) - GaP 570nm/Yellow Green              | (10) - GaAs/GaAs & GaAlAs/GaAs 940nm |
| (3) - GaAsP/GaP 585nm/Yellow              | (A) - GaN/SiC 430nm/Blue             |
| (4) - GaAsP/GaP 635nm/Orange & Hi-Eff Red | (B) - InGaN/SiC 470nm/Blue           |
| (5) - GaP 700nm/Bright Red                | (C) - InGaN/SiC 505nm/Ultra Green    |
| (6) - GaAlAs/GaAs 660nm/Super Red         | (D) - InGaAl/SiC 525nm/Ultra Green   |
| (8) - GaAsP/GaP 610nm/Super Red           |                                      |

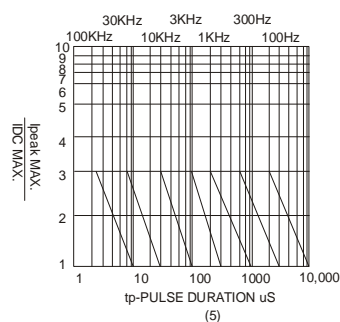
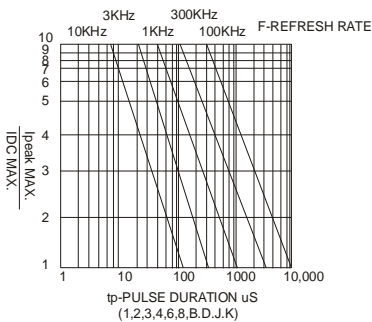
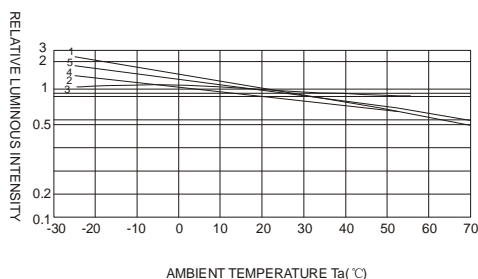
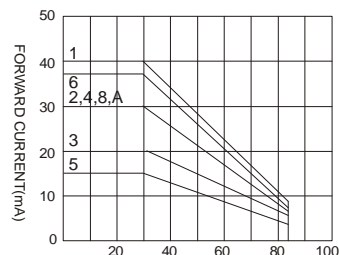
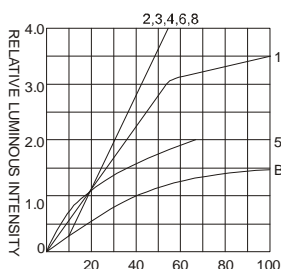
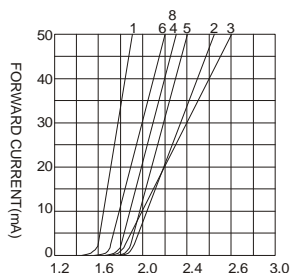

NOTE:25°C free air temperature unless otherwise specified



**NINGBO FORYARD OPTO  
ELECTRONICS CO.,LTD.**

# LED DIGIT DISPLAY

**PartNO.: FYS-3914AX/BX-XX**



| tapy           | QTY/foam(pcs) | QTY /Bundle (pcs) | QTY /CARTONDimension |
|----------------|---------------|-------------------|----------------------|
| FYS-3914A/B-xx | 14*19=266     | 266*16=4256       | 4256*4=17024         |
|                |               |                   |                      |
|                |               |                   |                      |

ADD: NO.115 QiXin Road NingBo Zhejiang China ZIP: 315051  
 TEL: 0086-574-87927870 87933652 FAX:0086-574-87927917  
[Http://www.foryard.com](http://www.foryard.com) E-mail:sales@foryard.com