

❖ MYK

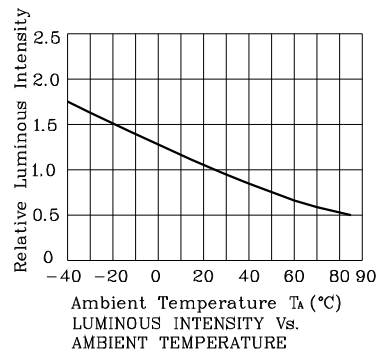
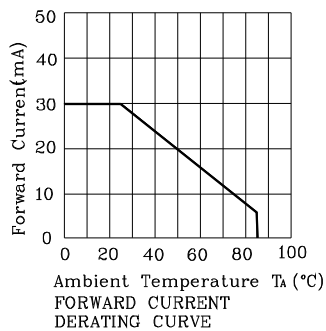
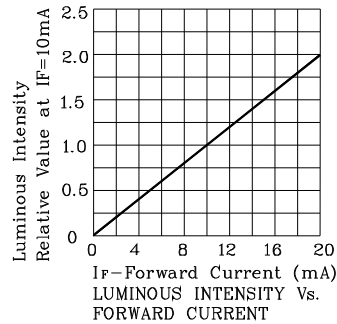
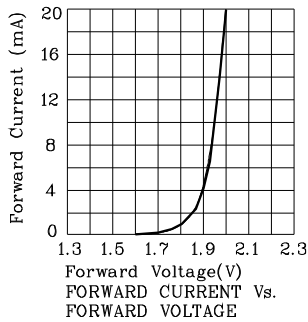

Remarks:

If special sorting is required (e.g. binning based on forward voltage, Luminous intensity / luminous flux, or wavelength), the typical accuracy of the sorting process is as follows:

1. Wavelength: +/-1nm
2. Luminous intensity / luminous flux: +/-15%
3. Forward Voltage: +/-0.1V

Note: Accuracy may depend on the sorting parameters.

Reflow Soldering Profile For Lead-free SMT Process.

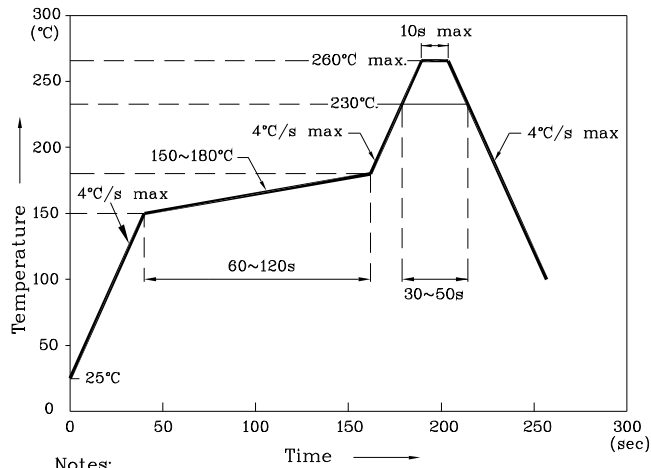

Notes:

1. Maximum soldering temperature should not exceed 260°C.
2. Recommended reflow temperature: 145°C-260°C.
3. Do not put stress to the epoxy resin during high temperatures conditions.

❖ Recommended Soldering Pattern (Units : mm;Tolerance:± 0.15)

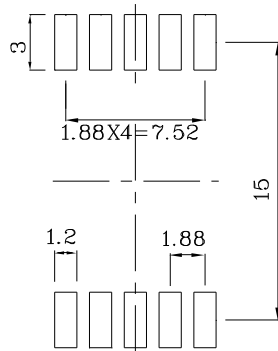

❖ Tape Specification (Units : mm)

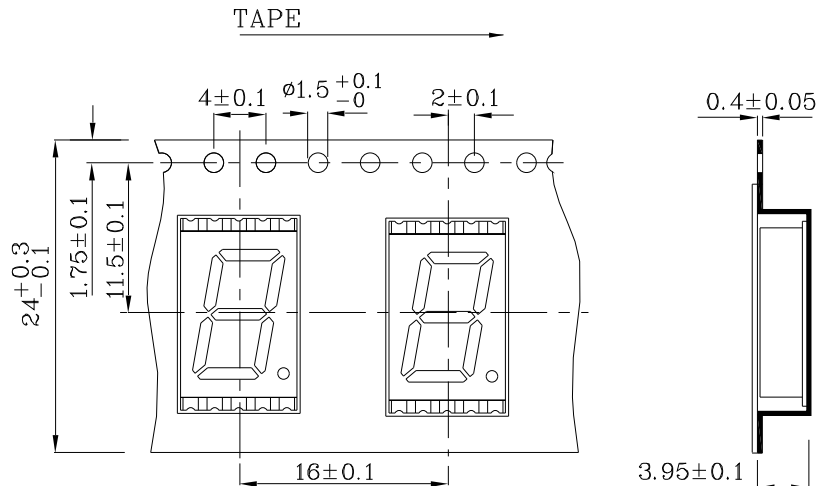

PACKING & LABEL SPECIFICATIONS

ZFMYK10C

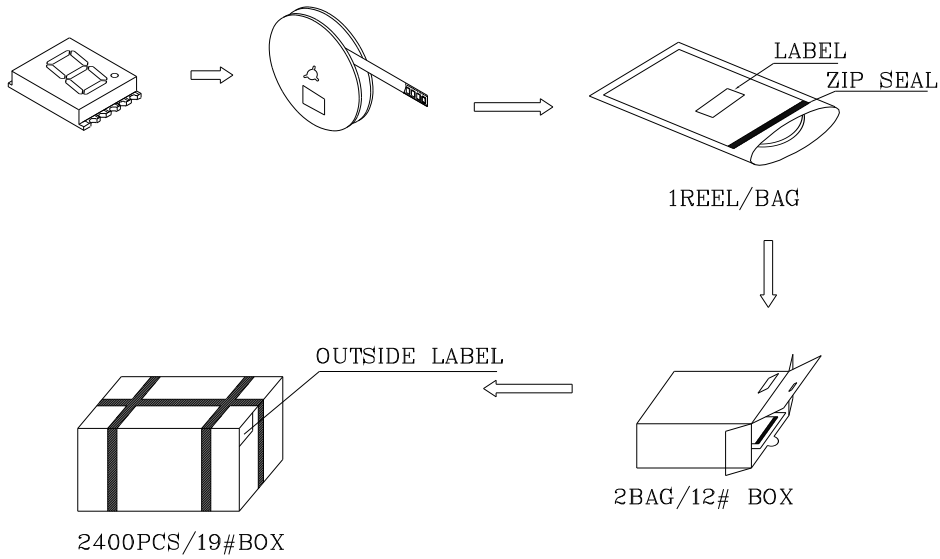

Outside LABEL Paste On The BAG

Inside LABEL Paste On The TAPE

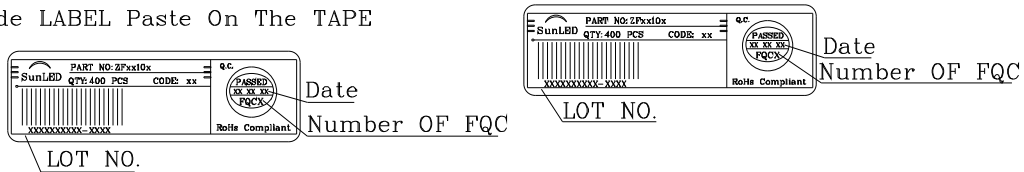

Outside LABEL Paste On The 19#Box

Outside LABEL Paste On The 12#Box

