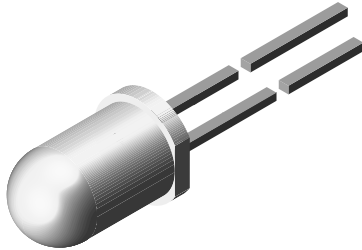


High Speed Infrared Emitting Diode, RoHS Compliant, 850 nm, GaAlAs Double Hetero



94 8389

DESCRIPTION

TSHG6210 is an infrared, 850 nm emitting diode in GaAlAs double hetero (DH) technology with high radiant power and high speed, molded in a clear, untinted plastic package.

FEATURES

- Package type: leaded
- Package form: T-1 $\frac{3}{4}$
- Dimensions (in mm): \varnothing 5
- Peak wavelength: $\lambda_p = 850$ nm
- High reliability
- High radiant power
- High radiant intensity
- Angle of half intensity: $\varphi = \pm 10^\circ$
- Low forward voltage
- Suitable for high pulse current operation
- High modulation bandwidth: $f_c = 18$ MHz
- Good spectral matching with CMOS cameras
- Lead (Pb)-free component in accordance with RoHS 2002/95/EC and WEEE 2002/96/EC


RoHS
COMPLIANT

APPLICATIONS

- Infrared radiation source for operation with CMOS cameras
- High speed IR data transmission
- Smoke-automatic fire detectors

PRODUCT SUMMARY

COMPONENT	I_e (mW/sr)	φ (deg)	λ_p (nm)	t_r (ns)
TSHG6210	230	± 10	850	20

Note

Test conditions see table "Basic Characteristics"

ORDERING INFORMATION

ORDERING CODE	PACKAGING	REMARKS	PACKAGE FORM
TSHG6210	Bulk	MOQ: 4000 pcs, 4000 pcs/bulk	T-1 $\frac{3}{4}$

Note

MOQ: minimum order quantity

ABSOLUTE MAXIMUM RATINGS

PARAMETER	TEST CONDITION	SYMBOL	VALUE	UNIT
Reverse voltage		V_R	5	V
Forward current		I_F	100	mA
Peak forward current	$t_p/T = 0.5$, $t_p = 100$ μ s	I_{FM}	200	mA
Surge forward current	$t_p = 100$ μ s	I_{FSM}	1	A
Power dissipation		P_V	180	mW
Junction temperature		T_j	100	$^\circ$ C
Operating temperature range		T_{amb}	- 40 to + 85	$^\circ$ C
Storage temperature range		T_{stg}	- 40 to + 100	$^\circ$ C
Soldering temperature	$t \leq 5$ s, 2 mm from case	T_{sd}	260	$^\circ$ C
Thermal resistance junction/ambient	J-STD-051, leads 7 mm, soldered on PCB	R_{thJA}	230	K/W

Note

$T_{amb} = 25$ $^\circ$ C, unless otherwise specified

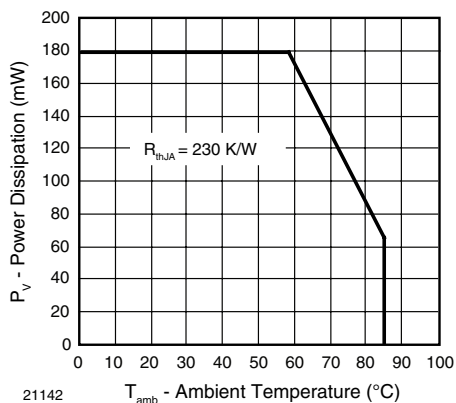


Fig. 1 - Power Dissipation Limit vs. Ambient Temperature

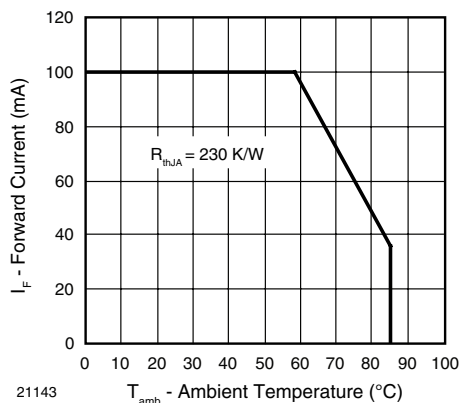


Fig. 2 - Forward Current Limit vs. Ambient Temperature

BASIC CHARACTERISTICS						
PARAMETER	TEST CONDITION	SYMBOL	MIN.	TYP.	MAX.	UNIT
Forward voltage	I _F = 100 mA, t _p = 20 ms	V _F		1.5	1.8	V
	I _F = 1 A, t _p = 100 μs	V _F		2.3		V
Temperature coefficient of V _F	I _F = 1 mA	TK _{V_F}		- 1.8		mV/K
Reverse current	V _R = 5 V	I _R			10	μA
Junction capacitance	V _R = 0 V, f = 1 MHz, E = 0	C _j		125		pF
Radiant intensity	I _F = 100 mA, t _p = 20 ms	I _e	140	230	420	mW/sr
	I _F = 1 A, t _p = 100 μs	I _e		2300		mW/sr
Radiant power	I _F = 100 mA, t _p = 20 ms	φ _e		55		mW
Temperature coefficient of φ _e	I _F = 100 mA	TKφ _e		- 0.35		%/K
Angle of half intensity		φ		± 10		deg
Peak wavelength	I _F = 100 mA	λ _p	820	850	880	nm
Spectral bandwidth	I _F = 100 mA	Δλ		40		nm
Temperature coefficient of λ _p	I _F = 100 mA	TKλ _p		0.25		nm/K
Rise time	I _F = 100 mA	t _r		20		ns
Fall time	I _F = 100 mA	t _f		13		ns
Cut-off frequency	I _{DC} = 70 mA, I _{AC} = 30 mA pp	f _c		18		MHz
Virtual source diameter		d		3.7		mm

Note

T_{amb} = 25 °C, unless otherwise specified

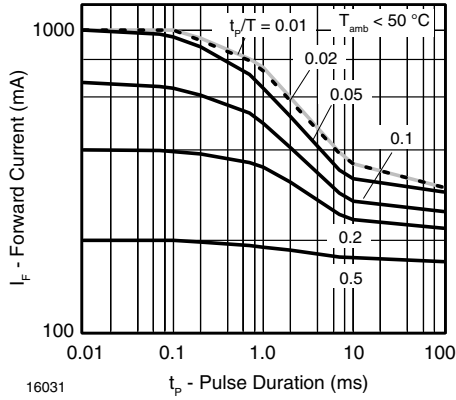
BASIC CHARACTERISTICS
 $T_{amb} = 25\text{ }^{\circ}\text{C}$, unless otherwise specified


Fig. 3 - Pulse Forward Current vs. Pulse Duration

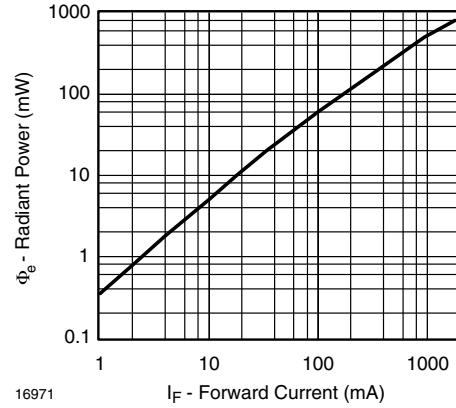


Fig. 6 - Radiant Power vs. Forward Current

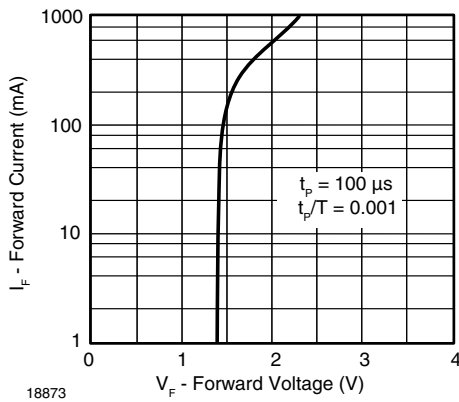


Fig. 4 - Forward Current vs. Forward Voltage

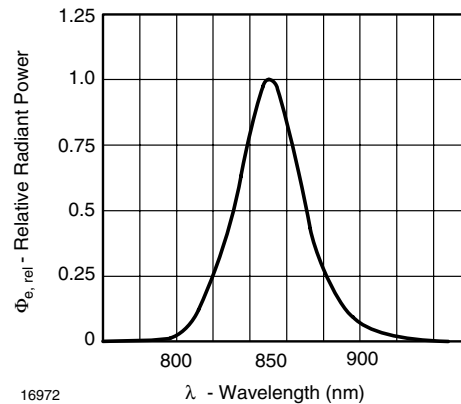


Fig. 7 - Relative Radiant Power vs. Wavelength

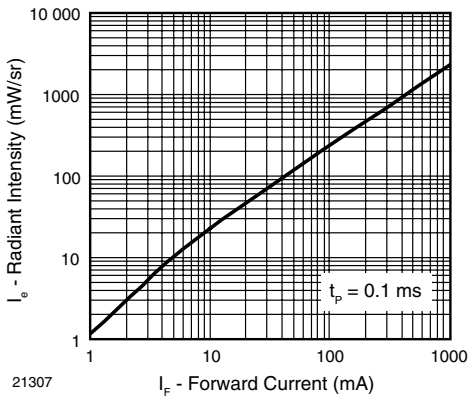


Fig. 5 - Radiant Intensity vs. Forward Current

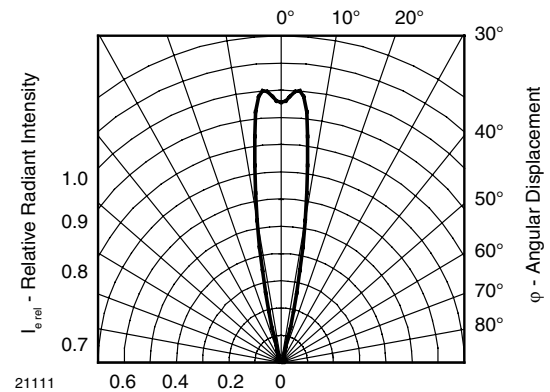


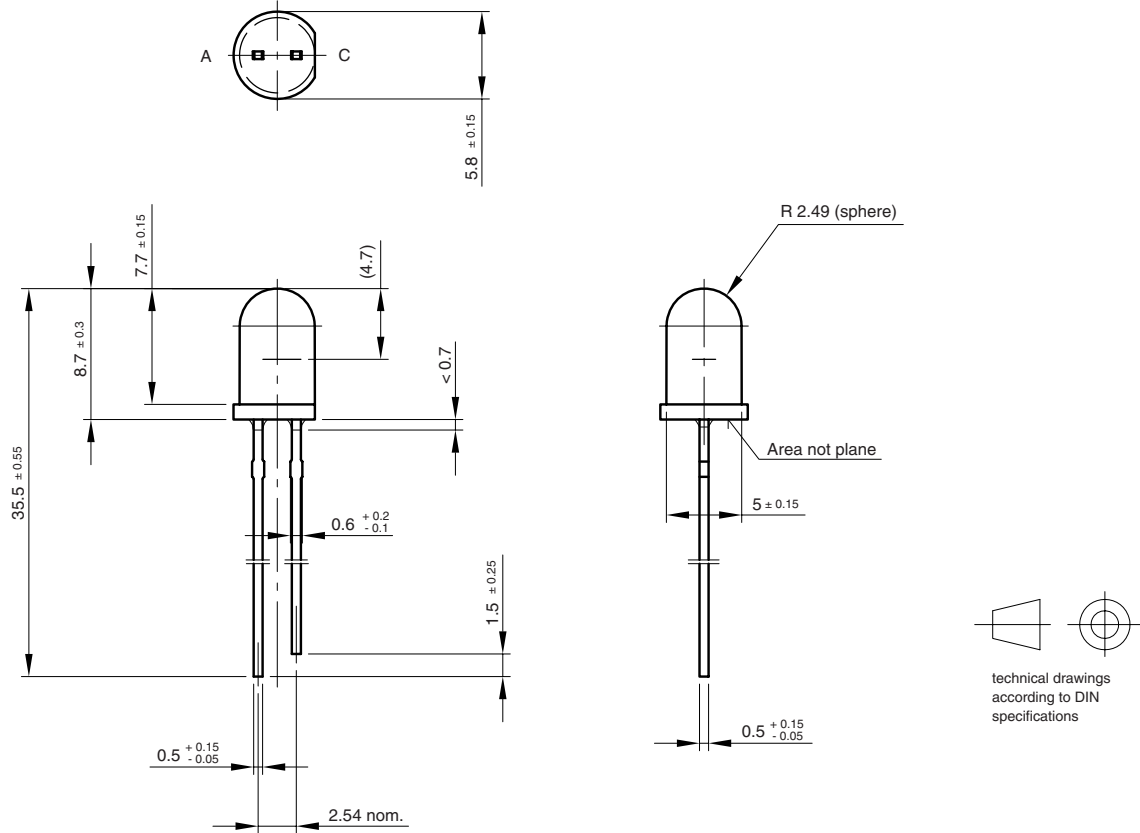
Fig. 8 - Relative Radiant Intensity vs. Angular Displacement

TSHG6210

Vishay Semiconductors High Speed Infrared Emitting Diode, RoHS Compliant, 850 nm, GaAlAs Double Hetero



PACKAGE DIMENSIONS in millimeters



6.544-5259.02-4
Issue: 7; 29.10.02
95 10917



Disclaimer

All product specifications and data are subject to change without notice.

Vishay Intertechnology, Inc., its affiliates, agents, and employees, and all persons acting on its or their behalf (collectively, "Vishay"), disclaim any and all liability for any errors, inaccuracies or incompleteness contained herein or in any other disclosure relating to any product.

Vishay disclaims any and all liability arising out of the use or application of any product described herein or of any information provided herein to the maximum extent permitted by law. The product specifications do not expand or otherwise modify Vishay's terms and conditions of purchase, including but not limited to the warranty expressed therein, which apply to these products.

No license, express or implied, by estoppel or otherwise, to any intellectual property rights is granted by this document or by any conduct of Vishay.

The products shown herein are not designed for use in medical, life-saving, or life-sustaining applications unless otherwise expressly indicated. Customers using or selling Vishay products not expressly indicated for use in such applications do so entirely at their own risk and agree to fully indemnify Vishay for any damages arising or resulting from such use or sale. Please contact authorized Vishay personnel to obtain written terms and conditions regarding products designed for such applications.

Product names and markings noted herein may be trademarks of their respective owners.