

Silicon PNP Power Transistors

2SA963

DESCRIPTION

- With TO-126 package
- Complement to type 2SC2209
- High collector power dissipation

APPLICATIONS

- For low-frequency power amplification

PINNING

PIN	DESCRIPTION
1	Emitter
2	Collector;connected to mounting base
3	Base

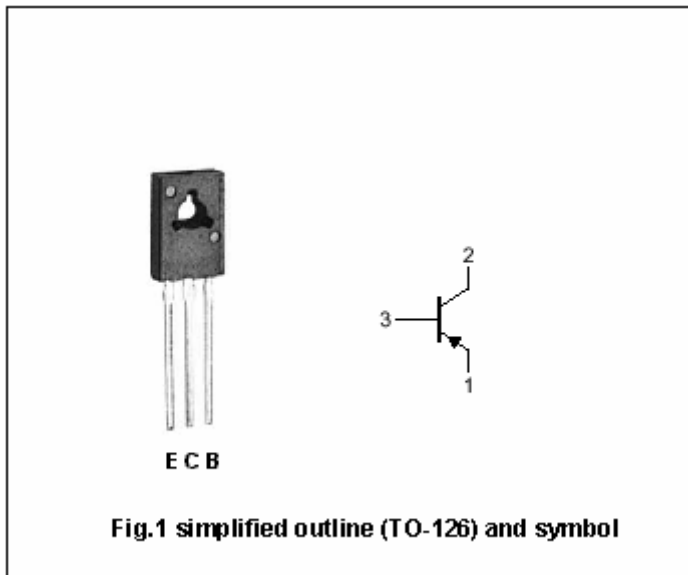

Absolute Maximun Ratings (Ta=25°C)

SYMBOL	PARAMETER	CONDITIONS	VALUE	UNIT
$V_{CBO}$	Collector-base voltage	Open emitter	-50	V
$V_{CEO}$	Collector-emitter voltage	Open base	-40	V
$V_{EBO}$	Emitter-base voltage	Open collector	-5	V
$I_C$	Collector current (DC)		-1.5	A
$I_{CM}$	Collector current-peak		-3	A
$P_C$	Collector power dissipation	$T_C=25^\circ C$	10	W
$T_j$	Junction temperature		150	$^\circ C$
$T_{stg}$	Storage temperature		-55~150	$^\circ C$

## Silicon PNP Power Transistors

## 2SA963

## CHARACTERISTICS

T<sub>j</sub>=25°C unless otherwise specified

SYMBOL	PARAMETER	CONDITIONS	MIN	TYP.	MAX	UNIT
V <sub>(BR)CEO</sub>	Collector-emitter breakdown voltage	I <sub>C</sub> =-2mA; I <sub>B</sub> =0	-40			V
V <sub>(BR)CBO</sub>	Collector-base breakdown voltage	I <sub>C</sub> =-1mA; I <sub>E</sub> =0	-50			V
V <sub>CEsat</sub>	Collector-emitter saturation voltage	I <sub>C</sub> =-1.5A; I <sub>B</sub> =-150mA			-1.0	V
V <sub>BEsat</sub>	Base-emitter saturation voltage	I <sub>C</sub> =-2A; I <sub>B</sub> =-0.2A			-1.5	V
I <sub>CBO</sub>	Collector cut-off current	V <sub>CB</sub> =-20V; I <sub>E</sub> =0			-1	μ A
I <sub>CEO</sub>	Collector cut-off current	V <sub>CE</sub> =-10V; I <sub>B</sub> =0			-100	μ A
I <sub>EBO</sub>	Emitter cut-off current	V <sub>EB</sub> =-5V; I <sub>C</sub> =0			-10	μ A
h <sub>FE</sub>	DC current gain	I <sub>C</sub> =-1A; V <sub>CE</sub> =-5V	80		220	
C <sub>OB</sub>	Output capacitance	I <sub>E</sub> =0; V <sub>CB</sub> =-5V; f=1MHz		70		pF
f <sub>T</sub>	Transition frequency	I <sub>E</sub> =0.5A; V <sub>CB</sub> =-5V; f=200MHz		150		MHz

◆ h<sub>FE</sub> Classifications

Q	R
80-160	120-220

PACKAGE OUTLINE

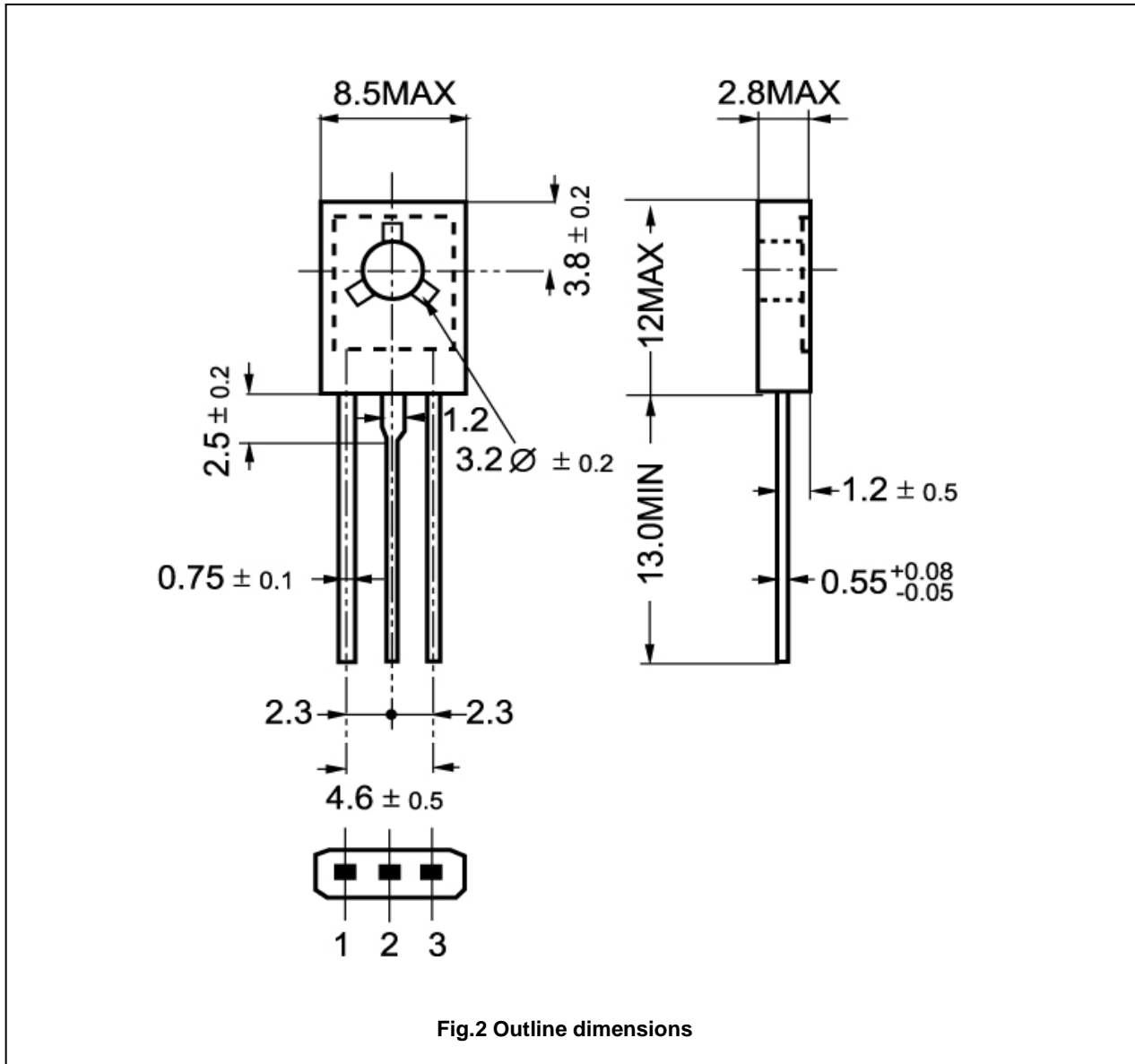

Silicon PNP Power Transistors

2SA963

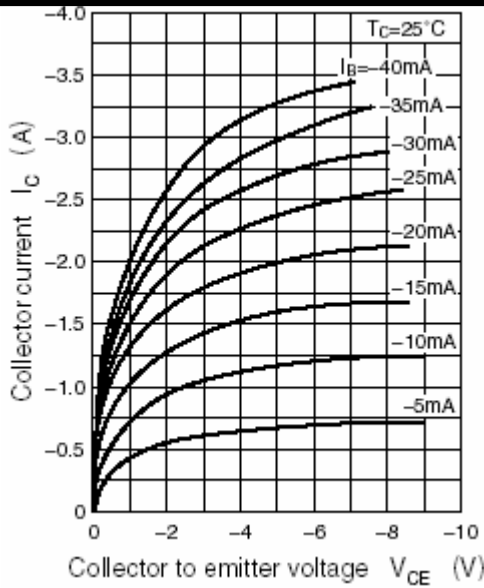

Fig.3 Static Characteristic

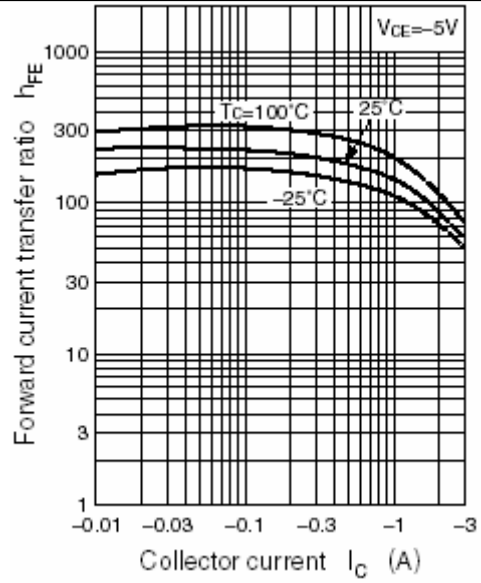

Fig.4 DC current Gain

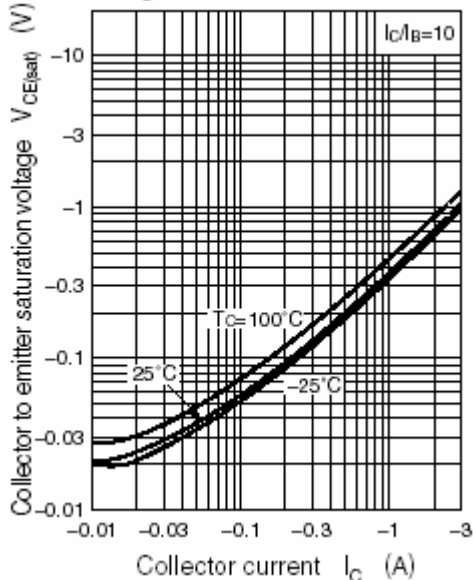

Fig.5 Collector-Emitter Saturation Voltage

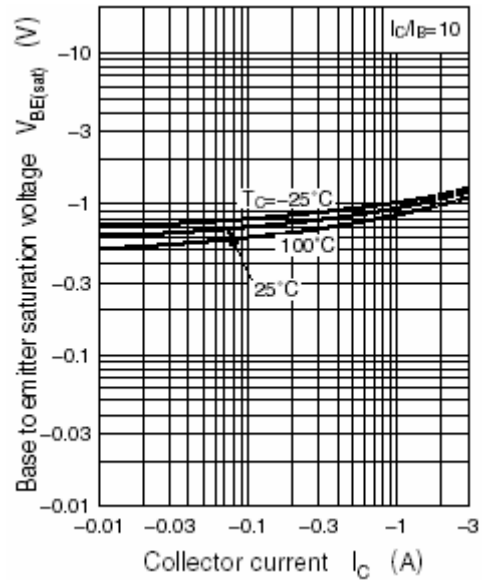

Fig.6 Base-Emitter Saturation Voltage

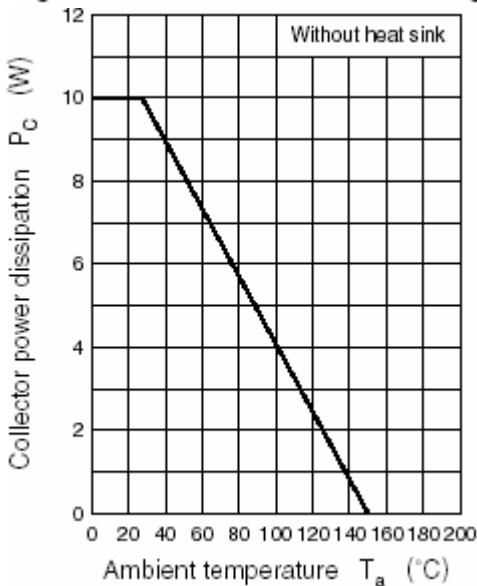

Fig.7 Power Derating

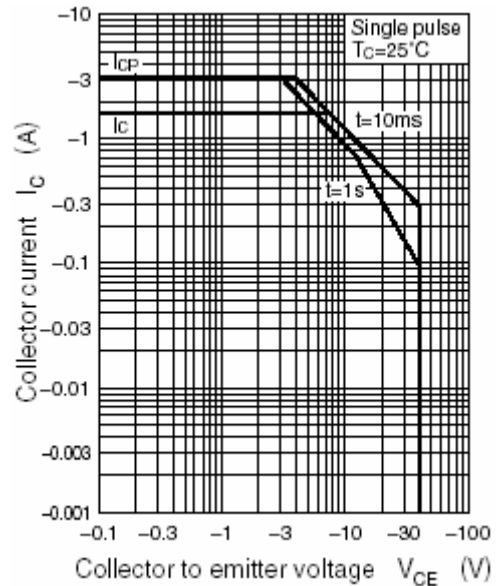

Fig.8 Safe Operating Area