

M52742ASP

BUS Controlled 3-Channel Video Preamp for CRT Display Monitor

REJ03F0192-0201

Rev.2.01

Mar 31, 2008

Description

M52742ASP is semiconductor integrated circuit for CRT display monitor.

It includes OSD blanking, OSD mixing, retrace blanking, wide band amplifier, brightness control, uniformity function.

Main/sub contrast and OSD adjust function can be controlled by I²C BUS.

Features

- Frequency band width: RGB 200 MHz (at -3 dB)
OSD 80 MHz
- Input: RGB 0.7 V_{P-P} (typ.)
OSD 3 V_{P-P} min. (positive)
BLK (for OSD) 3 V_{P-P} min. (positive)
Retrace BLK 3 V_{P-P} min. (positive)
- Output: RGB 5.5 V_{P-P} (max.)
OSD 5 V_{P-P} (max.)
- Main contrast and sub contrast can be controlled by I²C BUS.
- Include internal and external pedestal clamp circuit.

Application

CRT display monitor

Recommended Operating Condition

Supply voltage range:	11.5 to 12.5 V (V3, V8, V12, V36)
	4.5 to 5.5 V (V17)
Rated supply voltage:	12.0 V (V3, V8, V12, V36)
	5.0 V (V17)

Major Specification

BUS controlled 3ch video pre-amp with OSD mixing function and retrace blanking function

Block Diagram

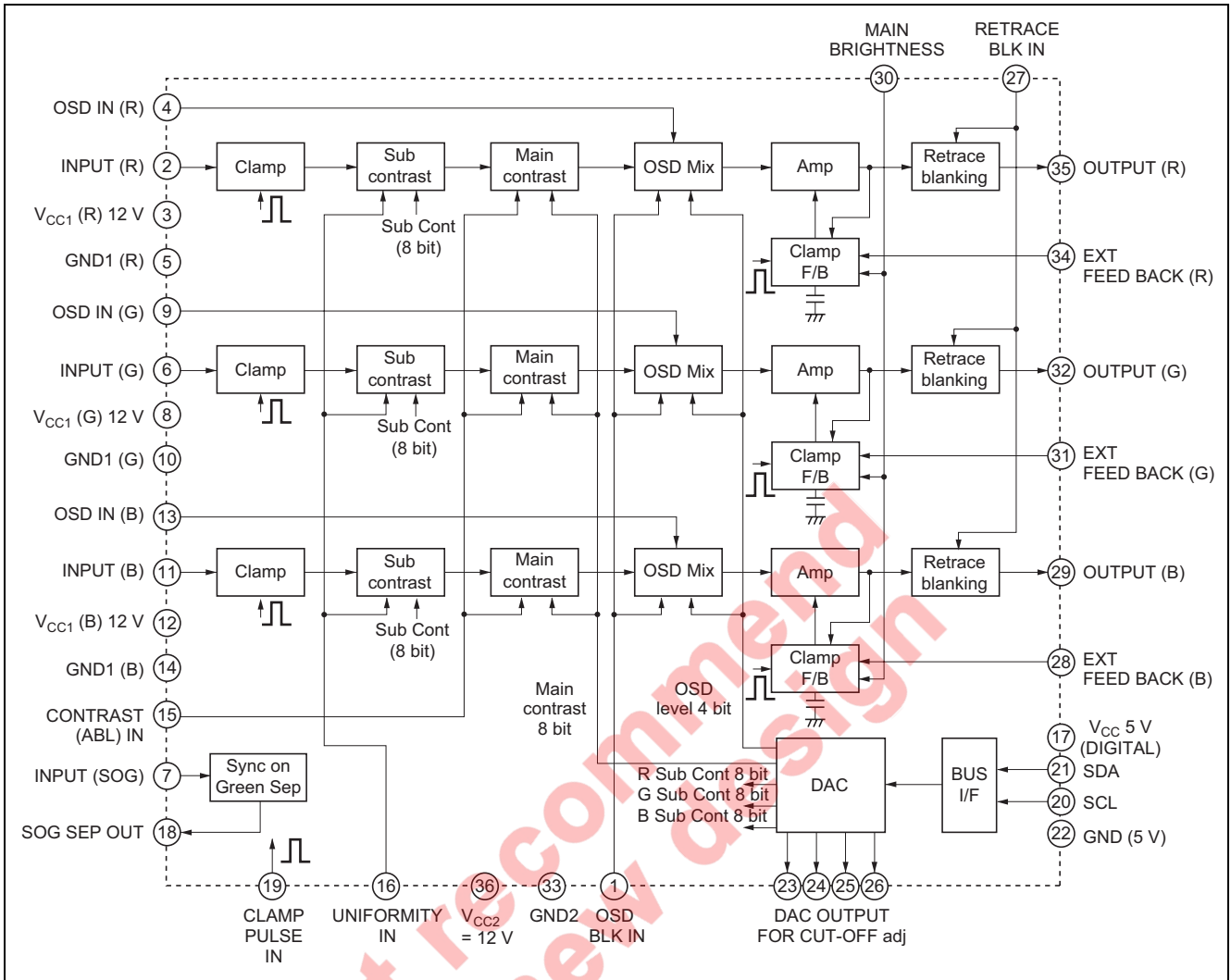

Pin Arrangement

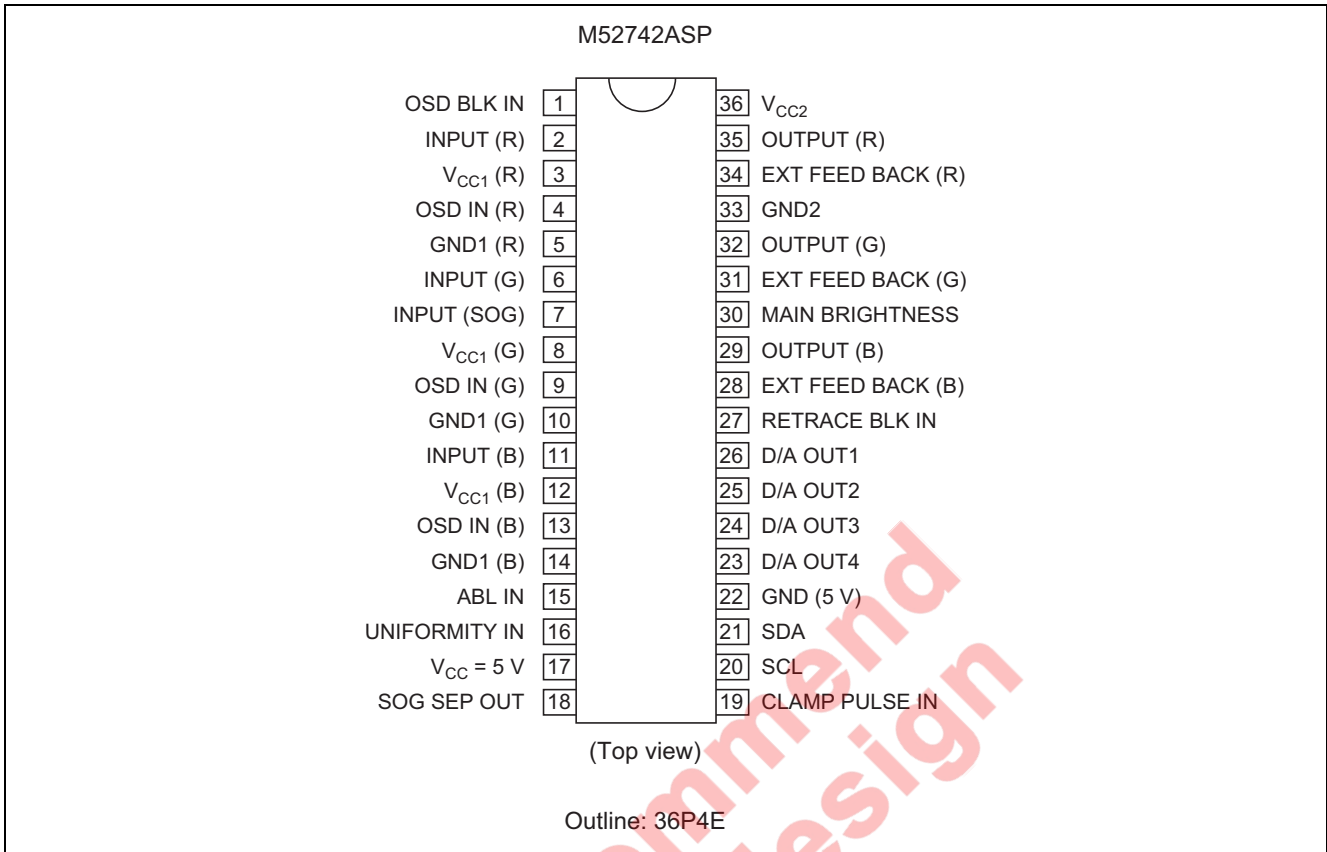

Not recommended for new design

Absolute Maximum Ratings

(Ta = 25°C)

Item	Symbol	Ratings	Unit
Supply voltage (pins 3, 8, 12, 36)	V _{CC12}	13.0	V
Supply voltage (pin 17)	V _{CC5}	6.0	V
Power dissipation	P _d	2403	mW
Ambient temperature	T _{opr}	-20 to +75	°C
Storage temperature	T _{stg}	-40 to +150	°C
Recommended supply 12	V _{opr12}	12.0	V
Recommended supply 5	V _{opr5}	5.0	V

Electrical Characteristics

(V_{CC} = 12 V, 5 V, Ta = 25°C, unless otherwise noted)

Item	Symbol	Limits			Unit	Test Point (s)	Input										CTL Voltage		BUS CTL (H)									
		Min.	Typ.	Max.			2, 6, 11 RGB in	1 OSD BLK	4, 9, 13 OSD in	19 CP in	27 ReT BLK	7 SOG in	16 UNI in	30 Bright	15 ABL	00H Main Cont	01H Sub Cont 1	02H Sub Cont 2	03H Sub Cont 3	04H OSD Adj	05H BLK Adj	06H D/A OUT 1	07H D/A OUT 2	08H D/A OUT 3	09H D/A OUT 4	0BH INT EXT		
Circuit current1	I _{CC1}	—	126	146	mA	I _A	a	a	a	b SG5	a	a	a	4.0	5.0	FFH 265	FFH 255	FFH 255	FFH 255	00H 0	00H 0	FFH 255	FFH 255	FFH 255	FFH 255	00H 0		
Circuit current2	I _{CC2}	—	18	25	mA	I _B	a	a	a	b SG5	a	a	a	4.0	5.0													
Output dynamic range	V _{omax}	6.0	8.0	—	V _{P-P}	OUT	b SG2	a	a	b SG5	a	a	a	Variable	5.0													
Maximum input	V _{imax}	1.6	—	—	V _{P-P}	IN OUT	b SG2 Variable	a	a	b SG5	a	a	a	2.0	5.0	64H 100												
Maximum gain	G _v	16.5	17.7	19.4	dB	OUT	b SG1	a	a	b SG5	a	a	a	2.0	5.0	FFH 265												
Relative maximum gain	ΔG _v	0.8	1.0	1.2	—	—	—	—	—	—	—	—	—	—	—	—	—	—	—	—	—	—	—	—	—	—		
Main contrast control characteristics1	V _{C1}	15.5	17.0	18.5	dB	OUT	b SG1	a	a	b SG5	a	a	a	2.0	5.0	C8H 200												
Main contrast control relative characteristics1	ΔV _{C1}	0.8	1.0	1.2	—	—	—	—	—	—	—	—	—	—	—	—	—	—	—	—	—	—	—	—	—	—		
Main contrast control characteristics2	V _{C2}	9.5	11.0	12.5	dB	OUT	b SG1	a	a	b SG5	a	a	a	2.0	5.0	64H 100												
Main contrast control relative characteristics2	ΔV _{C2}	0.8	1.0	1.2	—	—	—	—	—	—	—	—	—	—	—	—	—	—	—	—	—	—	—	—	—	—		
Main contrast control characteristics3	V _{C3}	0.2	0.4	0.6	V _{P-P}	OUT	b SG1	a	a	b SG5	a	a	a	2.0	5.0	14H 20												
Main contrast control relative characteristics3	ΔV _{C3}	0.8	1.0	1.2	—	—	—	—	—	—	—	—	—	—	—	—	—	—	—	—	—	—	—	—	—	—		
Sub contrast control characteristics1	V _{SC1}	16.0	17.5	19.0	dB	OUT	b SG1	a	a	b SG5	a	a	a	2.0	5.0	FFH 255	C8H 200	C8H 200	C8H 200									
Sub contrast control relative characteristics1	ΔV _{SC1}	0.8	1.0	1.2	—	—	—	—	—	—	—	—	—	—	—	—	—	—	—	—	—	—	—	—	—	—		
Sub contrast control characteristics2	V _{SC2}	12.0	13.5	15.0	dB	OUT	b SG1	a	a	b SG5	a	a	a	2.0	5.0	FFH 255	64H 100	64H 100	64H 100									
Sub contrast control relative characteristics2	ΔV _{SC2}	0.8	1.0	1.2	—	—	—	—	—	—	—	—	—	—	—	—	—	—	—	—	—	—	—	—	—	—		
Sub contrast control characteristics3	V _{SC3}	1.5	1.9	2.2	V _{P-P}	OUT	b SG1	a	a	b SG5	a	a	a	2.0	5.0	FFH 255	14H 20	14H 20	14H 20									
Sub contrast control relative characteristics3	ΔV _{SC3}	0.8	1.0	1.2	—	—	—	—	—	—	—	—	—	—	—	—	—	—	—	—	—	—	—	—	—	—		

Electrical Characteristics (cont.)

Item	Symbol	Limits			Unit	Test Point (s)	Input										CTL Voltage		BUS CTL (H)																			
		Min.	Typ.	Max.			2, 6, 11 RGB in	1 OSD BLK	4, 9, 13 OSD in	19 CP in	27 ReT BLK	7 SOG in	16 UNI in	30 Bright	15 ABL	00H Main Cont	01H Sub Cont 1	02H Sub Cont 2	03H Sub Cont 3	04H OSD Adj	05H BLK Adj	06H D/A OUT 1	07H D/A OUT 2	08H D/A OUT 3	09H D/A OUT 4	0BH INT EXT												
Sync output delay time ²	TDS-R	0	60	90	ns	Sync OUT	a	a	a	a	a	a	a	a	a	2.0	5.0	—	—	—	—	—	—	—	—	—	—	—	—	—	—	—	—	—	—	—	—	
D/A H output voltage	VOH	4.5	5.0	5.5	V _{DC}	D/A OUT	a	a	a	a	a	a	a	a	a	2.0	5.0	FFH 255	FFH 255	FFH 255	FFH 255	00H 0	00H 0	00H 0	00H 0	00H 0	00H 0	00H 0	00H 0	00H 0	00H 0	00H 0	00H 0	00H 0	00H 0	00H 0		
D/A L output voltage	VOL	0	0.5	1.0	V _{DC}	D/A OUT	a	a	a	a	a	a	a	a	a	2.0	5.0	↓	↓	↓	↓	↓	↓	↓	↓	↓	↓	↓	↓	↓	↓	↓	↓	↓	↓	↓	↓	
D/A nonlinearity	DNL	-1.0	—	1.0	LSB	D/A OUT	a	a	a	a	a	a	a	a	a	2.0	5.0	↓	↓	↓	↓	↓	↓	↓	↓	↓	↓	↓	↓	↓	↓	↓	↓	↓	↓	↓	↓	
Uniformity characteristics ¹	UNI1	7	10	13	%	OUT	b SG1	a	a	b SG5	a	a	b SG6 2.5 V	2.0	5.0	C8H 200	C8H 200	C8H 200	C8H 200	↓	↓	↓	↓	↓	↓	↓	↓	↓	↓	↓	↓	↓	↓	↓	↓	↓	↓	
Uniformity characteristics ²	UNI2	3.5	5	6.5	%	OUT	b SG1	a	a	b SG5	a	a	b SG6 1.25 V	2.0	5.0	↓	↓	↓	↓	↓	↓	↓	↓	↓	↓	↓	↓	↓	↓	↓	↓	↓	↓	↓	↓	↓	↓	
D/A input current range	IA-	0.18	—	—	mA	D/A OUT	a	a	a	a	a	a	a	a	2.0	5.0	00H 0	00H 0	00H 0	00H 0	00H 0	00H 0	00H 0	00H 0	00H 0	00H 0	00H 0	00H 0	00H 0	00H 0	00H 0	00H 0	00H 0	00H 0	00H 0	00H 0		
D/A output current range	IA+	—	—	1.0	mA	D/A OUT	a	a	a	a	a	a	a	a	2.0	5.0	↓	↓	↓	↓	↓	↓	↓	↓	↓	↓	↓	↓	↓	↓	↓	↓	↓	↓	↓	↓	↓	↓

Electrical Characteristics Test Method

I_{CC1} Circuit Current¹

Measuring conditions are as listed in supplementary Table.

Measured with a current meter at test point I_A.

I_{CC2} Circuit Current²

Measuring conditions are as listed in supplementary Table.

Measured with a current meter at test point I_B.

V_{omax} Output Dynamic Range

Decrease V30 gradually, and measure the voltage when the waveform output is distorted. The voltage is called VOL.

Next, increase V30 gradually, and measure the voltage when the top of waveform output is distorted. The voltage is called VOH.

Voltage V_{omax} is calculated by the equation below:

$$V_{omax} = VOH - VOL$$

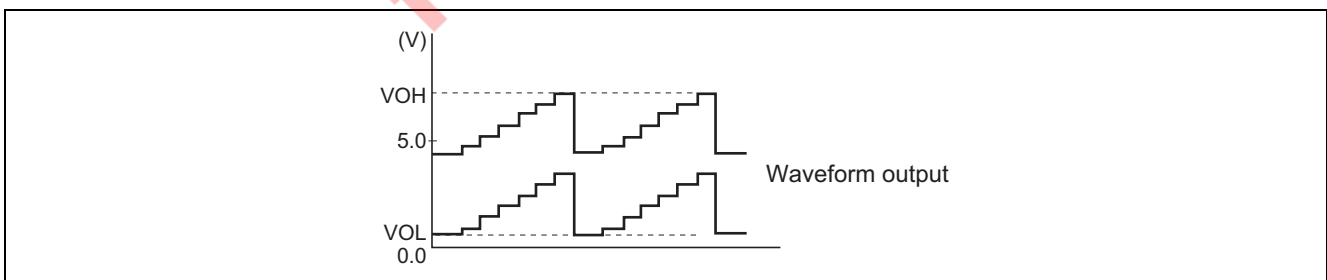

V_{imax} Maximum Input

Increase the input signal (SG2) amplitude gradually, starting from 700 mV_{p-p}. Measure the amplitude of the input signal when the output signal starts becoming distorted.

G_V Maximum Gain

Input SG1, and read the amplitude output at OUT (29, 32, 35). The amplitude is called VOUT (29, 32, 35). Maximum gain G_V is calculated by the equation below:

$$G_V = 20 \log \frac{V_{OUT}}{0.7} \text{ (dB)}$$

ΔG_V Relative Maximum Gain

Relative maximum gain ΔG_V is calculated by the equation below:

$$\Delta G_V = V_{OUT} (29) / V_{OUT} (32), \\ V_{OUT} (32) / V_{OUT} (35), \\ V_{OUT} (35) / V_{OUT} (29)$$

V_{C1} Main Contrast Control Characteristics1

Measuring the amplitude output at OUT (29, 32, 35). The measured value is called VOUT (29, 32, 35). Main contrast control characteristics V_{C1} is calculated by the equation below:

$$V_{C1} = 20 \log \frac{V_{OUT}}{0.7} \text{ (dB)}$$

ΔV_{C1} Main Contrast Control Relative Characteristics1

Relative characteristics ΔV_{C1} is calculated by the equation below:

$$\Delta V_{C1} = V_{OUT} (29) / V_{OUT} (32), \\ V_{OUT} (32) / V_{OUT} (35), \\ V_{OUT} (35) / V_{OUT} (29)$$

V_{C2} Main Contrast Control Characteristics2

Measuring condition and procedure are the same as described in V_{C1}.

ΔV_{C2} Main Contrast Control Relative Characteristics2

Measuring condition and procedure are the same as described in ΔV_{C1}.

V_{C3} Main Contrast Control Characteristics3

Measuring the amplitude output at OUT (29, 32, 35).

The measured value is called VOUT (29, 32, 35).

ΔV_{C3} Main Contrast Control Relative Characteristics3

Measuring condition and procedure are the same as described in ΔV_{C1}.

V_{SC1} Sub Contrast Control Characteristics1

Measure the amplitude output at OUT (29, 32, 35). The measured value is called V_{OUT} (29, 32, 35). Sub contrast control characteristics V_{SC1} is calculated by the equation below:

$$V_{SC1} = 20 \log \frac{V_{OUT}}{0.7} \text{ (dB)}$$

ΔV_{SC1} Sub Contrast Control Relative Characteristics1

Relative characteristics ΔV_{SC1} is calculated by the equation below:

$$\begin{aligned} \Delta V_{SC1} &= V_{OUT} (29) / V_{OUT} (32), \\ &V_{OUT} (32) / V_{OUT} (35), \\ &V_{OUT} (35) / V_{OUT} (29). \end{aligned}$$

V_{SC2} Sub Contrast Control Characteristics2

Measuring condition and procedure are the same as described in V_{SC1}.

ΔV_{SC2} Sub Contrast Control Relative Characteristics2

Measuring condition and procedure are the same as described in ΔV_{SC1}.

V_{SC3} Sub Contrast Control Characteristics3

Measuring the amplitude output at OUT (29, 32, 35).

The measured value is called V_{SC3}

ΔV_{SC3} Sub Contrast Control Relative Characteristics3

Measuring condition and procedure are the same as described in ΔV_{SC1}.

VMSC Main/sub Contrast Control Characteristics

Measure the amplitude output at OUT (29, 32, 35). The measured value is called VMSC.

ΔVMSC Main/sub Contrast Control Relative Characteristics

Relative characteristics ΔVMSC is calculated by the equation below:

$$\begin{aligned} \Delta VMSC &= V_{OUT} (29) / V_{OUT} (32), \\ &V_{OUT} (32) / V_{OUT} (35), \\ &V_{OUT} (35) / V_{OUT} (29) \end{aligned}$$

ABL1 ABL Control Characteristics1

Measure the amplitude output at OUT (29, 32, 35). The measured value is called V_{OUT} (29, 32, 35), and is treated as ABL1.

ΔABL1 ABL Control Relative Characteristics1

Relative characteristics ΔABL1 is calculated by the equation below:

$$\begin{aligned} \Delta ABL1 &= V_{OUT} (29) / V_{OUT} (32) , \\ &V_{OUT} (32) / V_{OUT} (35) , \\ &V_{OUT} (35) / V_{OUT} (29) \end{aligned}$$

ABL2 ABL Control Characteristics2

Measuring condition and procedure are the same as described in ABL1.

ΔABL2 ABL Control Relative Characteristics2

Measuring condition and procedure are the same as described in ΔABL1.

V_{B1} Brightness Control Characteristics1

Measure the DC voltage at OUT (29, 32, 35) with a voltmeter. The measured value is called V_{OUT} (29, 32, 35), and is treated as V_{B1}.

ΔV_{B1} Brightness Control Relative Characteristics1

Relative characteristics ΔV_{B1} is calculated by the difference in the output between the channels.

$$\begin{aligned} \Delta V_{B1} = & V_{OUT} (29) - V_{OUT} (32), \\ & V_{OUT} (32) - V_{OUT} (35), \\ & V_{OUT} (35) - V_{OUT} (29) \end{aligned}$$

V_{B2} Brightness Control Characteristics2

Measuring condition and procedure are the same as described in V_{B1}.

ΔV_{B2} Brightness Control Relative Characteristics2

Measuring condition and procedure are the same as described in ΔV_{B1}.

V_{B3} Brightness Control Characteristics3

Measuring condition and procedure are the same as described in V_{B1}.

ΔV_{B3} Brightness Control Relative Characteristics3

Measuring condition and procedure are the same as described in ΔV_{B1}.

F_{C1} Frequency Characteristics1 (f = 50 MHz)

First, SG3 to 1 MHz is as input signal. Input a resistor that is about 2 kΩ to offer the voltage at input pins (2, 6, 11) in order that the bottom of input signal is 2.5 V. Control the main contrast in order that the amplitude of sine wave output is 4.0 V_{P-P}. Control the brightness in order that the bottom of sine wave output is 2.0 V_{P-P}. By the same way, measure the output amplitude when SG3 to 50 MHz is as input signal. The measured value is called V_{OUT} (29, 32, 35). Frequency characteristics F_{C1} (29, 32, 35) is calculated by the equation below:

$$F_{C1} = 20 \log \frac{V_{OUT} V_{P-P}}{\text{Output amplitude when inputted SG3 (1 MHz): } 4 V_{P-P}} \quad (\text{dB})$$

ΔF_{C1} Frequency Relative Characteristics1 (f = 50 MHz)

Relative characteristics ΔF_{C1} is calculated by the difference in the output between the channels.

F_{C1'} Frequency Characteristics1 (f = 200 MHz)

Measuring condition and procedure are the same as described in table, expect SG3 to 200 MHz.

ΔF_{C1'} Frequency Relative Characteristics1 (f = 200 MHz)

Relative characteristics ΔF_{C1'} is calculated by the difference in the output between the channels.

F_{C2} Frequency Characteristics2 (f = 200 MHz)

SG3 to 1 MHz is as input signal. Control the main contrast in order that the amplitude of sine wave output is 1.0 V_{P-P}. By the same way, measure the output amplitude when SG3 to 200 MHz is as input signal.

The measured value is called VOUT (29, 32, 35). Frequency characteristics F_{C2} (29, 32, 35) is calculated by the equation below:

$$F_{C2} = 20 \log \frac{V_{OUT} V_{P-P}}{\text{Output amplitude when inputted SG3 (1 MHz): } 4 V_{P-P}} \quad (\text{dB})$$

ΔF_{C2} Frequency Relative Characteristics2 (f = 200 MHz)

Relative characteristics ΔF_{C2} is calculated by the difference in the output between the channels.

C.T.1 Crosstalk1 (f = 50 MHz)

Input SG3 (50 MHz) to pin 2 only, and then measure the waveform amplitude output at OUT (29, 32, 35). The measured value is called VOUT (29, 32, 35). Crosstalk C.T.1 is calculated by the equation below:

$$C.T.1 = 20 \log \frac{V_{OUT} (29, 32)}{V_{OUT} (35)} \quad (\text{dB})$$

C.T.1' Crosstalk1 (f = 200 MHz)

Measuring condition and procedure are the same as described in C.T.1, expect SG3 to 200 MHz.

C.T.2 Crosstalk2 (f = 50 MHz)

Input SG3 (50 MHz) to pin 6 only, and then measure the waveform amplitude output at OUT (29, 32, 35). The measured value is called VOUT (29, 32, 35). Crosstalk C.T.2 is calculated by the equation below:

$$C.T.2 = 20 \log \frac{V_{OUT} (29, 32)}{V_{OUT} (35)} \quad (\text{dB})$$

C.T.2' Crosstalk2 (f = 200 MHz)

Measuring condition and procedure are the same as described in C.T.2, expect SG3 to 200 MHz.

C.T.3 Crosstalk3 (f = 50 MHz)

Input SG3 (50 MHz) to pin 11 only, and then measure the waveform amplitude output at OUT (29, 32, 35). The measured value is called VOUT (29, 32, 35). Crosstalk C.T.3 is calculated by the equation below:

$$C.T.3 = 20 \log \frac{V_{OUT} (29, 32)}{V_{OUT} (35)} \quad (\text{dB})$$

C.T.3' Crosstalk3 (f = 200 MHz)

Measuring condition and procedure are the same as described in C.T.3, expect SG3 to 200 MHz.

Tr Pulse Characteristics1 (4 V_{P-P})

Control the main contrast (00H) in order that the amplitude of output signal is 4.0 V_{P-P}.

Control the brightness (V30) in order that the Black level of output signal is 2.0 V.

Measure the time needed for the input pulse to rise from 10% to 90% (Tr1) and for the output pulse to rise from 10% to 90% (Tr2) with an active probe.

Pulse characteristics Tr is calculated by the equations below:

$$Tr = \sqrt{[(Tr2)^2 - (Tr1)^2]}$$

ΔTr Relative Pulse Characteristics1

Relative characteristics ΔTr is calculated by the difference in the output between the channels.

Tf Pulse Characteristics2 (4 V_{P-P})

Measure the time needed for the input pulse to fall from 90% to 10% (Tf1) and for the output pulse to fall from 90% to 10% (Tf2) with an active probe.

Pulse characteristics Tf is calculated by the equations below:

$$Tf = \sqrt{[(Tf2)^2 - (Tf1)^2]}$$

ΔTf Relative Pulse Characteristics2

Relative characteristics ΔTf is calculated by the difference in the output between the channels.

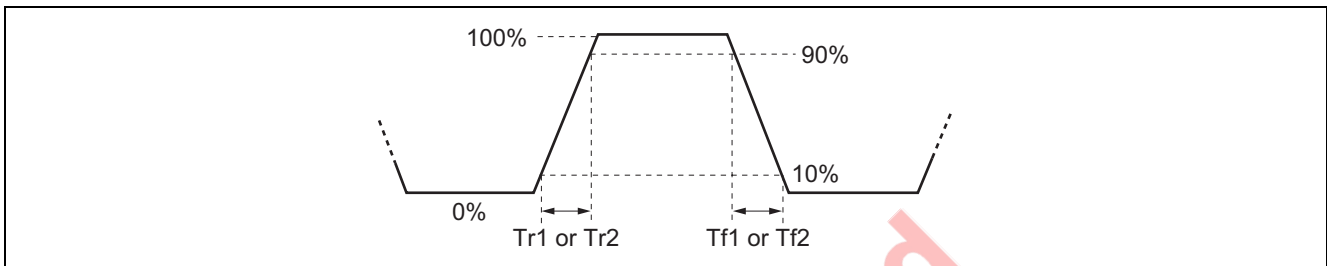
**VthCP Clamp Pulse Threshold Voltage**

Turn down the SG5 input level gradually from 5.0 V_{P-P}, monitoring the waveform output.

Measure the top level of input SG5 at when the output pedestal level is start to going down or unstable.

WCP Clamp Pulse Minimum Width

Decrease the SG5 pulse width gradually from 0.5 μs, monitoring the output. Measure the input SG5 pulse width (at the point of 1.5 V) at when output pedestal level is start to going down or unstable.

OTr OSD Pulse Characteristics1

Measure the time needed for the output pulse to rise from 10% to 90% (OTr) with an active probe.

OTf OSD Pulse Characteristics2

Measure the time needed for the output pulse to fall from 90% to 10% (OTf) with an active probe.

Oaj1 OSD Adjust Control Characteristics1

Measure the amplitude output at OUT (29, 32, 35). The measured value is called VOUT (29, 32, 35), and is treated as Oaj1.

ΔOaj1 OSD Adjust Control Relative Characteristics1

Relative characteristics ΔOaj1 is calculated by the equation below:

$$\Delta Oaj1 = \frac{VOUT(29)}{VOUT(32)},$$

$$\frac{VOUT(32)}{VOUT(35)},$$

$$\frac{VOUT(35)}{VOUT(29)}$$

Oaj2 OSD Adjust Control Characteristics2

Measuring condition and procedure are the same as described in Oaj1.

ΔOaj2 OSD Adjust Control Relative Characteristics2

Measuring condition and procedure are the same as described in ΔOaj1.

OBLK OSD BLK Characteristics

Output voltage-Black level voltage of "High" section of SG6 is calculated. The calculated value is called VOUT (29, 32, 35), and is treated as OBLK.

ΔOBLK OSD Relative Characteristics

Relative characteristics ΔOBLK is calculated by the equation below:

$$\begin{aligned}\Delta\text{OBLK} &= \text{VOUT (29)} - \text{VOUT (32)}, \\ &\quad \text{VOUT (32)} - \text{VOUT (35)}, \\ &\quad \text{VOUT (35)} - \text{VOUT (29)}\end{aligned}$$

VthOSD OSD Input Threshold Voltage

Reduce the SG6 input level gradually, monitoring output. Measure the SG6 level when the output reaches 0 V. The measured value is called VthOSD.

VthBLK OSD BLK Input Threshold Voltage

Confirm that output signal is being blanked by the SG6 at the time.

Monitoring to output signal, decreasing the level of SG6. Measure the top level of SG6 when the blanking period is disappeared. The measured value is called VthBLK.

HBLK1 Retrace BLK Characteristics1

Measure the amplitude output is blanked by the SG7 at OUT (29, 32, 35). The measured value is called VOUT (29, 32, 35), and is treated as HBLK1.

HBLK2 Retrace BLK Characteristics2

Measure the amplitude output is blanked by the SG7 at OUT (29, 32, 35). The measured value is called VOUT (29, 32, 35), and is treated as HBLK2.

HBLK3 Retrace BLK Characteristics3

Measure the amplitude output is blanked by the SG7 at OUT (29, 32, 35). The measured value is called VOUT (29, 32, 35), and is treated as HBLK3.

VthRET Retrace BLK Input Threshold Voltage

Confirm that output signal is being blanked by the SG7 at the time.

Monitoring to output signal, decreasing the level of SG7. Measure the top level of SG7 when the blanking period is disappeared. The measured value is called VthRET.

SS-NV SOG Input Maximum Noise Voltage

The sync's amplitude of SG4 be changed all white into all black, increase from 0 V_{p-p} to 0.02 V_{p-p}. No pulse output permitted.

SS-SV SOG Minimum Input Voltage

The sync's amplitude of SG4 be changed all white or all black, decrease from 0.3 V_{p-p} to 0.2 V_{p-p}. Confirm no malfunction produced by noise.

VSH Sync Output High Level

Measure the high voltage at SyncOUT. The measured value is treated as VSH.

VSL Sync Output Low Level

Measure the low voltage at SyncOUT. The measured value is treated as VSL.

TDS-F Sync Output Delay Time1

SyncOUT becomes High with sync part of SG4.

Measure the time needed for the front edge of SG4 sync to fall from 50% and for SyncOUT to rise from 50% with an active probe. The measured value is treated as TDS-F, less than 90 ns.

TDS-R Sync Output Delay Time2

Measure the time needed for the rear edge of SG4 sync to rise from 50% and for SyncOUT to fall from 50% with an active probe. The measured value is treated as TDS-R, less than 90 ns.

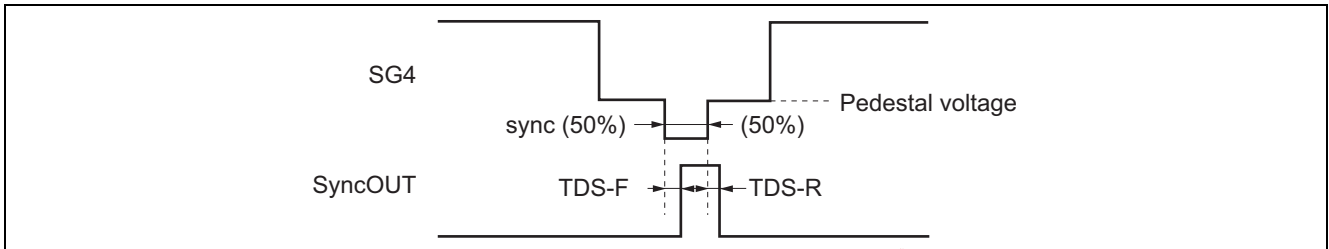

VOH D/A H Output Voltage

Measure the DC voltage at D/A OUT. The measured value is treated as VOH.

VOL D/A L Output Voltage

Measure the DC voltage at D/A OUT. The measured value is treated as VOL.

IAO D/A Output Current Range

Electric current flow from the output of D/A OUT must be less than 1.0 mA: IA+.

Electric current flow into the output of D/A OUT must be more than 0.18 mA: IA-.

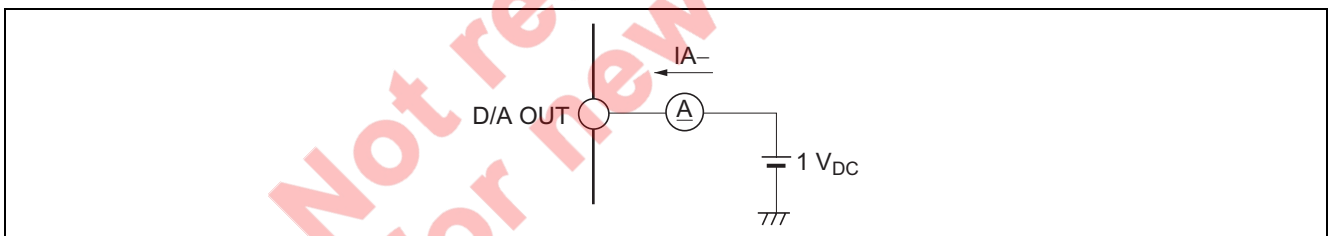

DNL D/A Nonlinearity

The difference of differential non-linearity of D/A OUT must be less than ±1.0 LSB.

UNI1 Uniformity Characteristics1, UNI2 Uniformity characteristics2

VuniA is amplitude output at OUT (29, 32, 35), when SG6 is low voltage. VuniB is amplitude output at OUT (29, 32, 35), when SG6 is high voltage.

Modulation ratio UNI (UNI2) is calculated by the equation below;

$$UNI1 (UNI2) = 100 \cdot (V_{uniB} / V_{uniA} - 1) (\%)$$

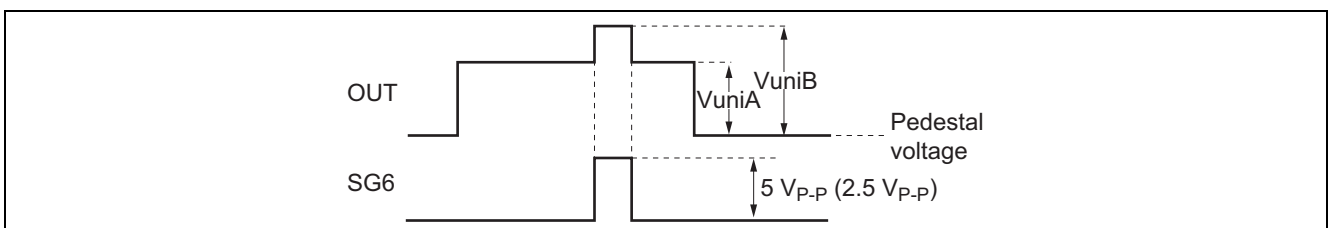

I²C BUS Protocol

(1) Slave address

D7	D6	D5	D4	D3	D2	D1	R/W	
1	0	0	0	1	0	0	0	= 88H

(2) Slave receiver format

S	Slave address	A	Sub address	A	Data byte	A	P
↑		↑					↑
Start condition		Acknowledge					Stop condition

(3) Sub address byte and data byte format

Function	Bit	Sub Add.	Data Byte (Top: Byte Format, Under: Start Condition)							
			D7	D6	D5	D4	D3	D2	D1	D0
Main contrast	8	00H	A07	A06	A05	A04	A03	A02	A01	A00
			0	1	0	0	0	0	0	0
Sub contrast R	8	01H	A17	A16	A15	A14	A13	A12	A11	A10
			1	0	0	0	0	0	0	0
Sub contrast G	8	02H	A27	A26	A25	A24	A23	A22	A21	A20
			1	0	0	0	0	0	0	0
Sub contrast B	8	03H	A37	A36	A35	A34	A33	A32	A31	A30
			1	0	0	0	0	0	0	0
OSD level	4	04H	—	—	—	—	A43	A42	A41	A40
			0	0	0	0	1	0	0	0
RE-BLK adjust	4	05H	—	—	—	—	A53	A52	A51	A50
			0	0	0	0	1	0	0	0
D/A OUT1	8	06H	A67	A66	A65	A64	A63	A62	A61	A60
			1	0	0	0	0	0	0	0
D/A OUT2	8	07H	A77	A76	A75	A74	A73	A72	A71	A70
			1	0	0	0	0	0	0	0
D/A OUT3	8	08H	A87	A86	A85	A84	A83	A82	A81	A80
			1	0	0	0	0	0	0	0
D/A OUT4	8	09H	A97	A96	A95	A94	A93	A92	A91	A90
			1	0	0	0	0	0	0	0
Pedestal clamp INT/EXT SW	1	0BH	—	—	—	—	—	—	—	AB0
			0	0	0	0	0	0	0	0

Note: Pedestal level INT/EXT SW
0 → INT 1 → EXT



Timing Requirement of I²C

Item	Symbol	Min.	Max.	Unit
Input voltage LOW	V_{IL}	-0.5	1.5	V
Input voltage HIGH	V_{IH}	3.0	5.5	V
SCL clock frequency	f_{SCL}	0	100	kHz
Time the bus must be free before a new transmission can start	t_{BUF}	4.7	—	μ S
Hold time start condition. After this period the first clock pulse is generated	$t_{HD:STA}$	4.0	—	μ S
The LOW period of the clock	t_{LOW}	4.7	—	μ S
The HIGH period of the clock	t_{HIGH}	4.0	—	μ S
Set up time for start condition (Only relevant for a repeated start condition)	$t_{SU:STA}$	4.7	—	μ S
Hold time for I ² C devices	$t_{HD:DAT}$	0	—	μ S
Set-up time DATA	$t_{SU:DAT}$	250	—	ns
Rise time of both SDA and SCL	t_r	—	1000	ns
Fall time of both SDA and SCL	t_f	—	300	ns
Set-up time for stop condition	$t_{SU:STO}$	4.0	—	μ S

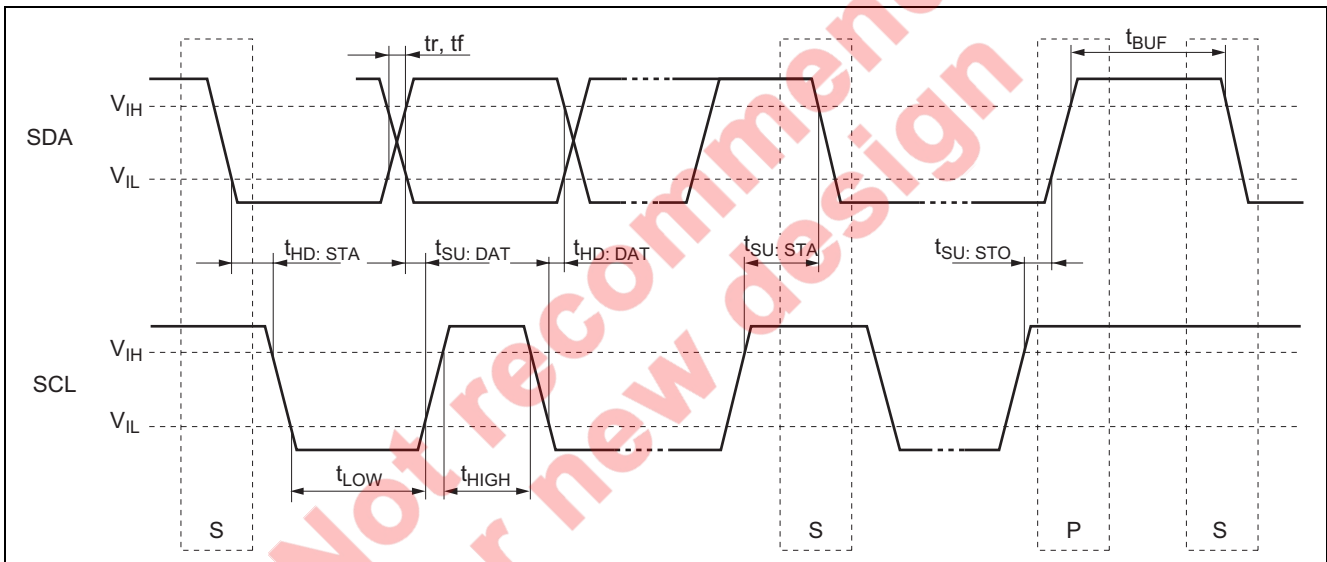
Timing Chart

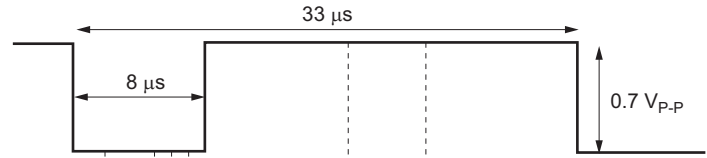
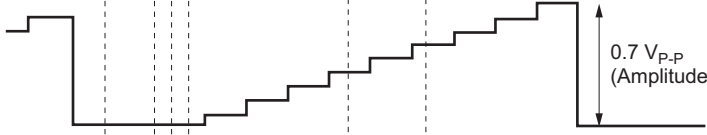
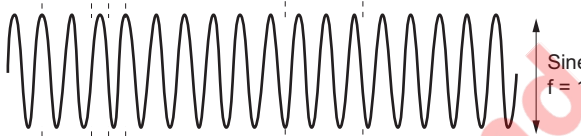
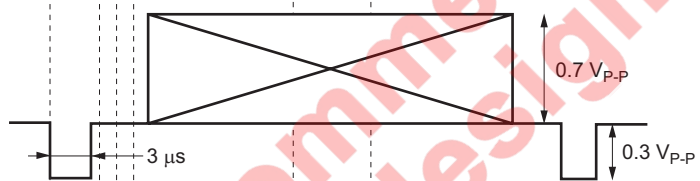
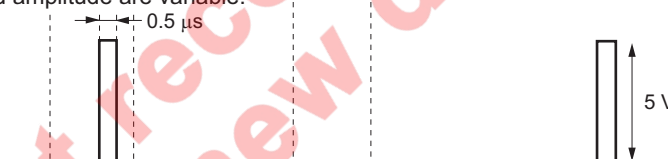
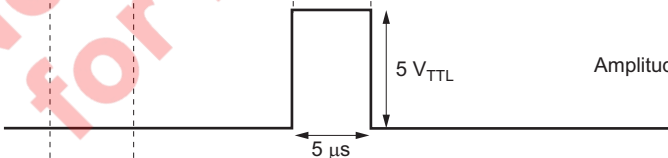

Input Signal

SG No.	Signals
SG1 Video signal (all white)	Pulse with amplitude of $0.7 V_{P-P}$ ($f = 30 \text{ kHz}$). Video width of $25 \mu\text{s}$. (75%) 
SG2 Video signal (step wave)	
SG3 Sine wave (for freq. char.)	
SG4 Video signal (all white, all black)	Video width of $25 \mu\text{s}$. (75%) 
SG5 Clamp pulse	Pulse width and amplitude are variable. 
SG6 OSD pulse	
SG7 BLK pulse	

Note: $f = 30 \text{ kHz}$

Test Circuit

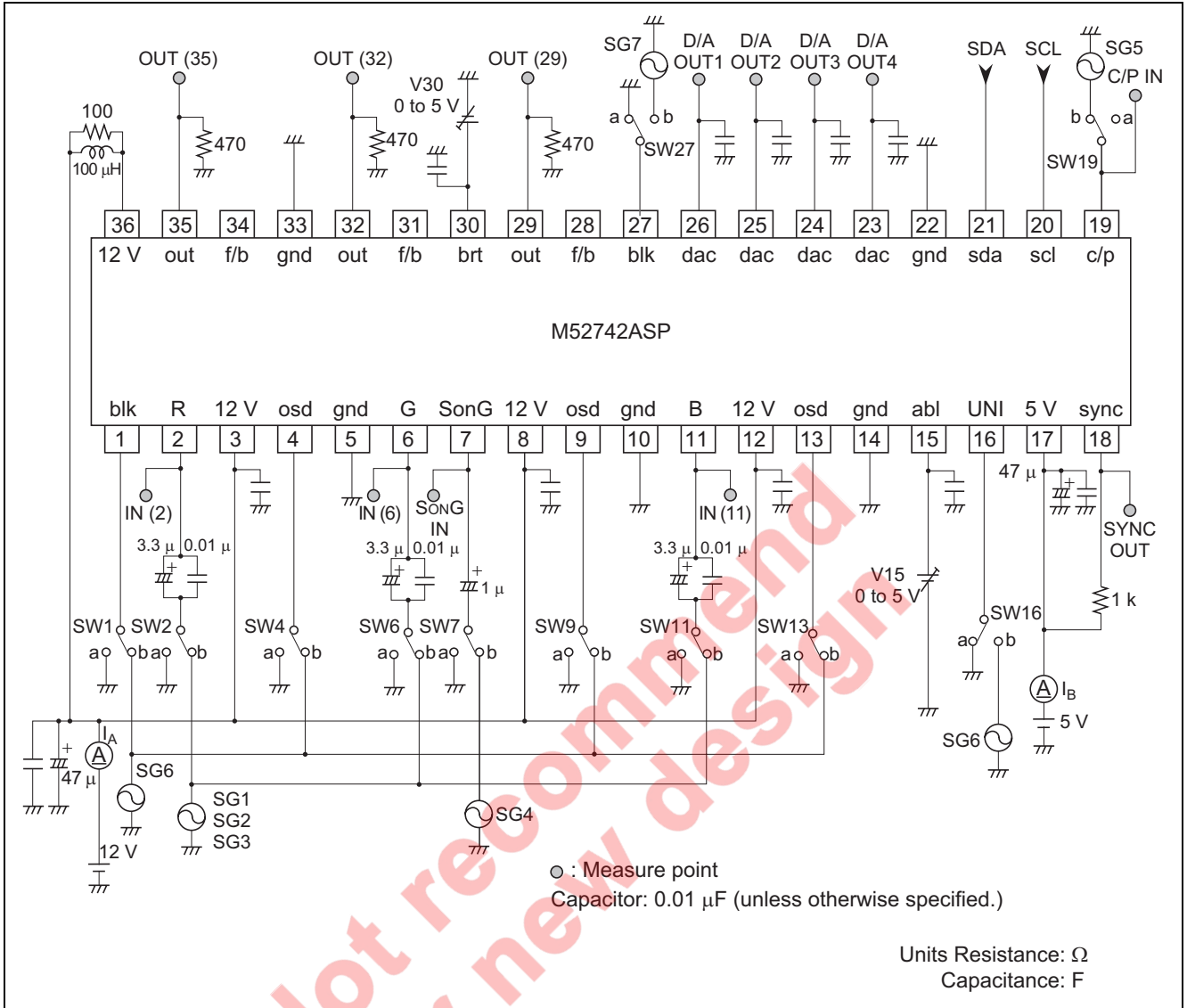

Typical Characteristics

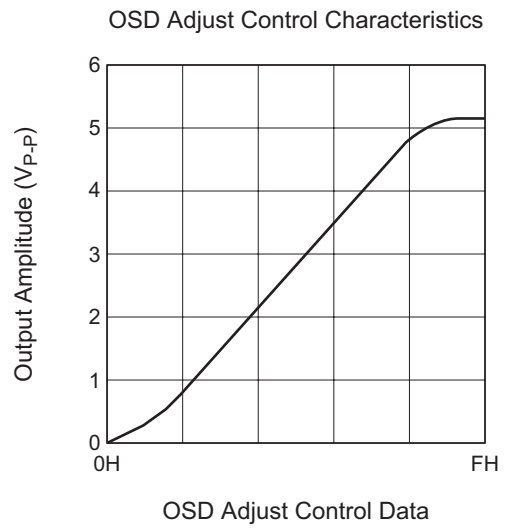
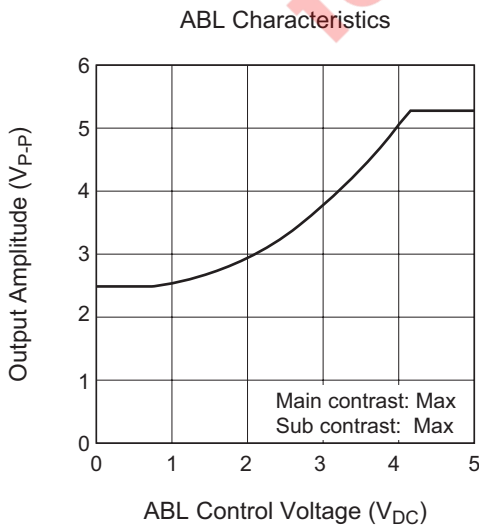
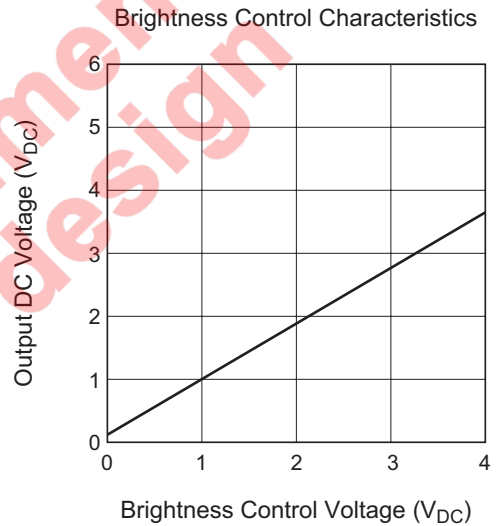
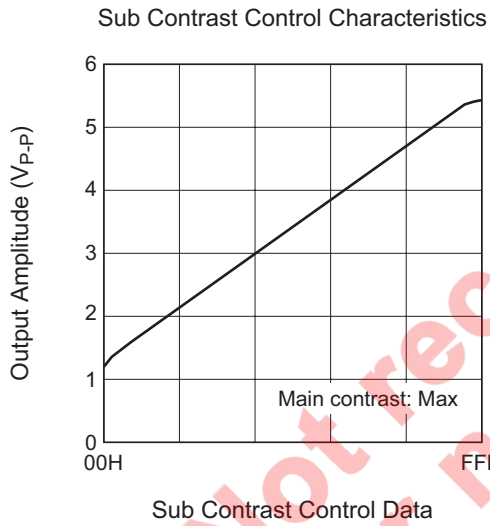
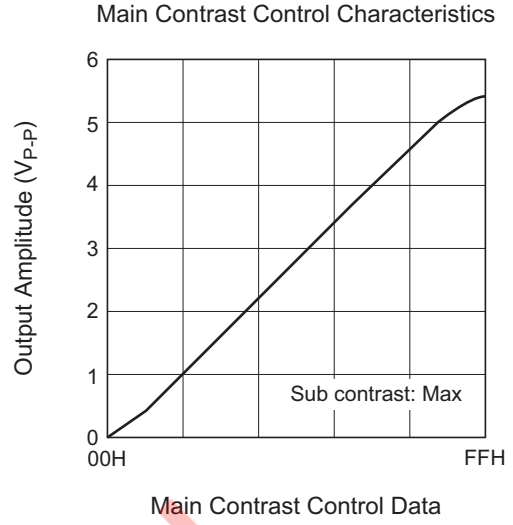
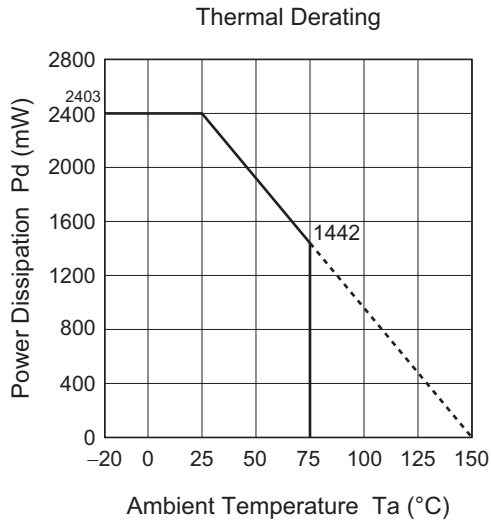

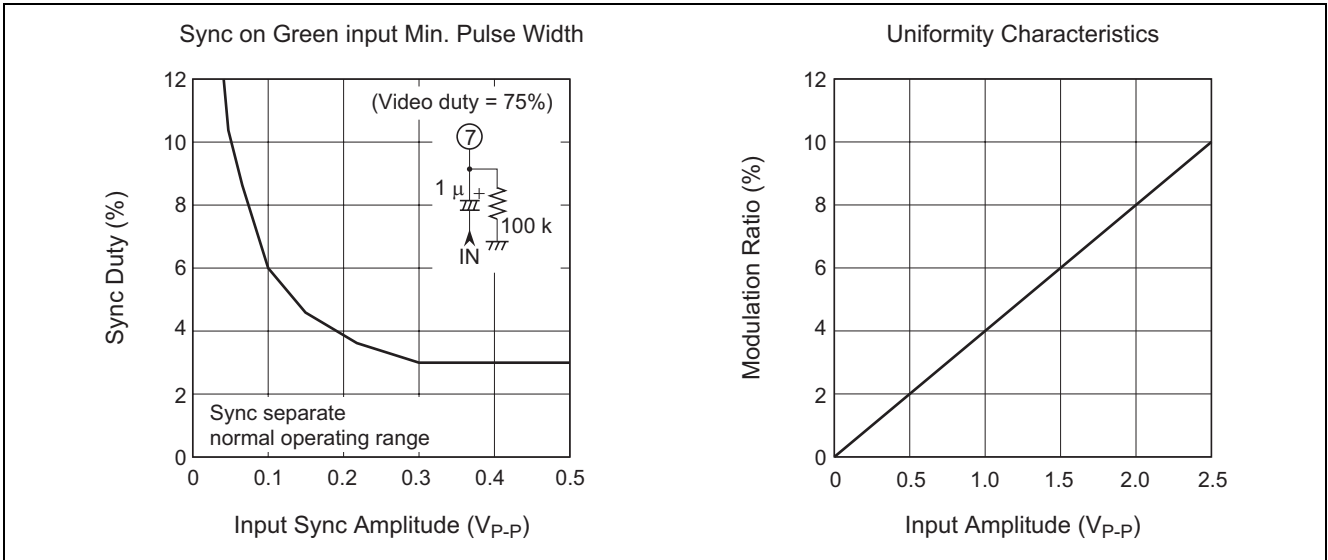

Not recommend for new design

Pin Description

Pin No.	Name	DC Voltage (V)	Peripheral Circuit	Function
1	OSD BLK IN	—		<ul style="list-style-type: none"> Input pulses <ul style="list-style-type: none"> Connected to GND if not used.
2 6 11	INPUT (R) INPUT (G) INPUT (B)	2.5		<ul style="list-style-type: none"> Clamped to about 2.5 V due to clamp pulses from pin 19. Input at low impedance.
3 8 12	V _{CC1} (R) V _{CC1} (G) V _{CC1} (B)	12	—	<ul style="list-style-type: none"> Apply equivalent voltage to 3 channels
4 9 13	OSD IN (R) OSD IN (G) OSD IN (B)	—		<ul style="list-style-type: none"> Input pulses <ul style="list-style-type: none"> Connected to GND if not used.
5 10 14 22 33	GND 1 (R) GND 1 (G) GND 1 (B) GND (5 V) GND 2	GND	—	—
7	INPUT (S on G)	When open 2.5 V		<ul style="list-style-type: none"> SYNC ON GREEN Input pin for sync separation. Sync is negative. Input signal at pin 7, compare with the reference voltage of internal circuit in order to separate sync signal. When not used, set to OPEN.

Pin Description (cont.)

Pin No.	Name	DC Voltage (V)	Peripheral Circuit	Function
15	ABL IN	When open 2.5 V		<ul style="list-style-type: none"> ABL (Automatic Beam Limiter) input pin. Recommended voltage range is 0 to 5 V. When ABL function is not used, set to 5 V.
16	Uniformity IN	5.75		<ul style="list-style-type: none"> Uniformity input pin. Recommended amplitude range is 0 to 5 V_{P-P}.
17	V _{CC} (5 V)	5	—	—
18	S on G Sep OUT	—		<ul style="list-style-type: none"> Sync signal output pin, Being of open collector output type.
19	Clamp Pulse IN	—		<ul style="list-style-type: none"> Input pulses <div style="text-align: center;"> </div> Input at low impedance.
20	SCL	—		<ul style="list-style-type: none"> SCL of I²C BUS (Serial clock line) V_{TH} = 2.3 V

Pin Description (cont.)

Pin No.	Name	DC Voltage (V)	Peripheral Circuit	Function
21	SDA	—		<ul style="list-style-type: none"> • SDA of I²C BUS (Serial data line) V_{TH} = 2.3 V
23 24 25 26	D/A OUT	—		<ul style="list-style-type: none"> • D/A output pin. Output voltage range is 0 to 5 V, min input current is 0.18 mA when D/A output pin is 1 V. Max output current is 1.0 mA.
27	Retrace BLK IN	—		<ul style="list-style-type: none"> • Input pulses • Connected to GND if not used.
28 31 34	EXT Feed Back (B) EXT Feed Back (G) EXT Feed Back (R)	Variable		
29 32 35	OUTPUT (B) OUTPUT (G) OUTPUT (R)	Variable		<ul style="list-style-type: none"> • A resistor is needed on the GND side. Set discretionally to maximum 15 mA, depending on the required driving capacity.
36	V _{CC2}	12		<ul style="list-style-type: none"> • Used to supply power to output emitter follower only.
30	Main Brightness	—		<ul style="list-style-type: none"> • It is recommended that the IC be used between pedestal voltage 2 V and 3 V.

Application Method for M52742ASP

Clamp Pulse Input

Clamp pulse width is recommended

above 15 kHz, 1.0 μ s

above 30 kHz, 0.5 μ s

above 64 kHz, 0.3 μ s.

The clamp pulse circuit in ordinary set is a long round about way, and beside high voltage, sometimes connected to external terminal, it is very easy affected by large surge.

Therefore, the figure shown right is recommended.

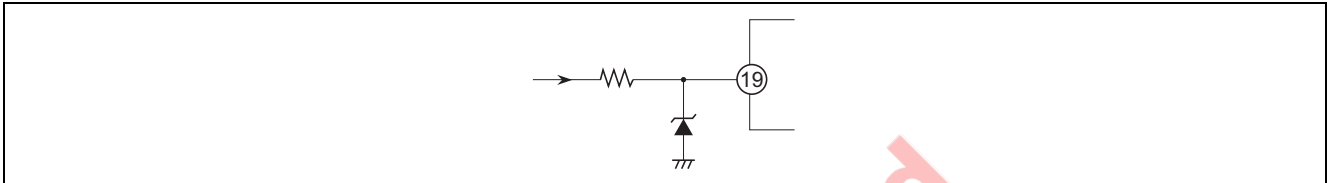

EXT-Feed Back

In case of application circuit example of lower figure, Set up R1, R2 which seems that the black level of the signal feed backed from Power AMP is 1 V, when the bottom of output signal is 1 V.

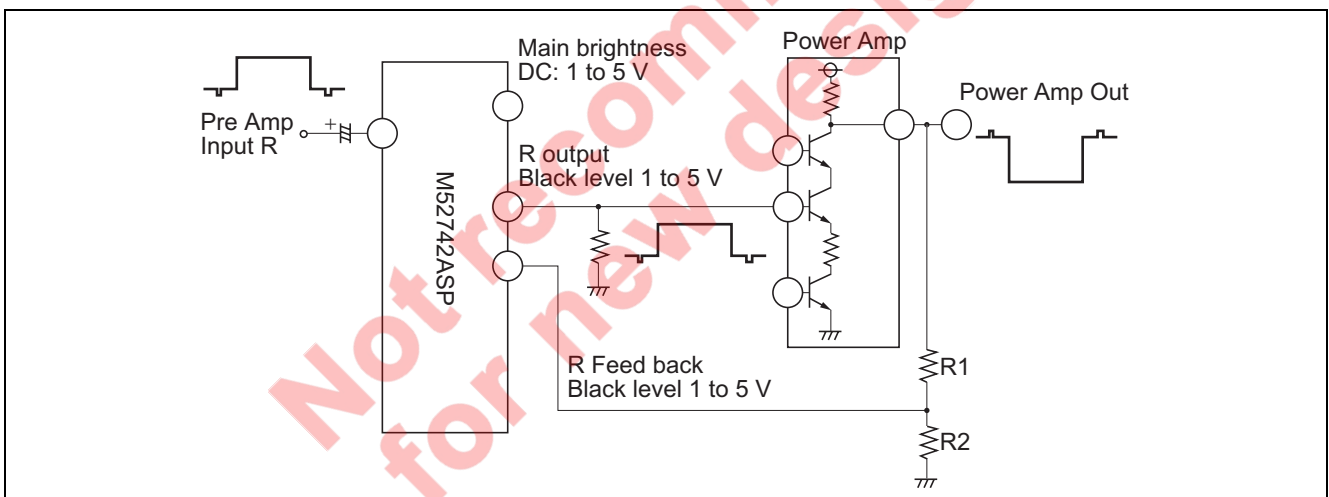

EXT-Feed Back Application Circuit

Notice of Application

- Make the nearest distance between output pin and pull down resistor.
- Recommended pedestal voltage of IC output signal is 2 V.

Package Dimensions

36P4E

Plastic 36pin 500mil SDIP

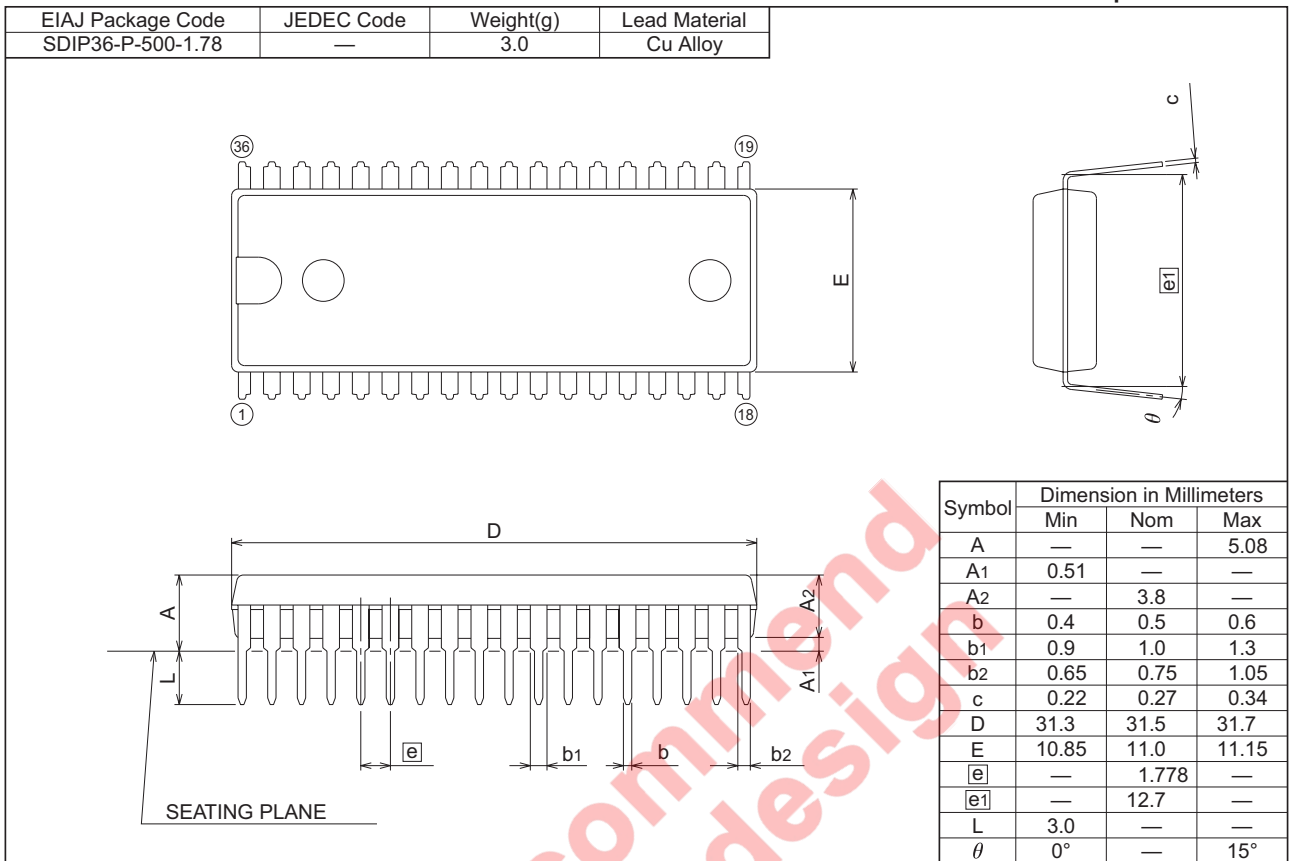

Not recommended for new designs

Notes:

1. This document is provided for reference purposes only so that Renesas customers may select the appropriate Renesas products for their use. Renesas neither makes warranties or representations with respect to the accuracy or completeness of the information contained in this document nor grants any license to any intellectual property rights or any other rights of Renesas or any third party with respect to the information in this document.
2. Renesas shall have no liability for damages or infringement of any intellectual property or other rights arising out of the use of any information in this document, including, but not limited to, product data, diagrams, charts, programs, algorithms, and application circuit examples.
3. You should not use the products or the technology described in this document for the purpose of military applications such as the development of weapons of mass destruction or for the purpose of any other military use. When exporting the products or technology described herein, you should follow the applicable export control laws and regulations, and procedures required by such laws and regulations.
4. All information included in this document such as product data, diagrams, charts, programs, algorithms, and application circuit examples, is current as of the date this document is issued. Such information, however, is subject to change without any prior notice. Before purchasing or using any Renesas products listed in this document, please confirm the latest product information with a Renesas sales office. Also, please pay regular and careful attention to additional and different information to be disclosed by Renesas such as that disclosed through our website. (<http://www.renesas.com>)
5. Renesas has used reasonable care in compiling the information included in this document, but Renesas assumes no liability whatsoever for any damages incurred as a result of errors or omissions in the information included in this document.
6. When using or otherwise relying on the information in this document, you should evaluate the information in light of the total system before deciding about the applicability of such information to the intended application. Renesas makes no representations, warranties or guarantees regarding the suitability of its products for any particular application and specifically disclaims any liability arising out of the application and use of the information in this document or Renesas products.
7. With the exception of products specified by Renesas as suitable for automobile applications, Renesas products are not designed, manufactured or tested for applications or otherwise in systems the failure or malfunction of which may cause a direct threat to human life or create a risk of human injury or which require especially high quality and reliability such as safety systems, or equipment or systems for transportation and traffic, healthcare, combustion control, aerospace and aeronautics, nuclear power, or undersea communication transmission. If you are considering the use of our products for such purposes, please contact a Renesas sales office beforehand. Renesas shall have no liability for damages arising out of the uses set forth above.
8. Notwithstanding the preceding paragraph, you should not use Renesas products for the purposes listed below:
 - (1) artificial life support devices or systems
 - (2) surgical implantations
 - (3) healthcare intervention (e.g., excision, administration of medication, etc.)
 - (4) any other purposes that pose a direct threat to human lifeRenesas shall have no liability for damages arising out of the uses set forth in the above and purchasers who elect to use Renesas products in any of the foregoing applications shall indemnify and hold harmless Renesas Technology Corp., its affiliated companies and their officers, directors, and employees against any and all damages arising out of such applications.
9. You should use the products described herein within the range specified by Renesas, especially with respect to the maximum rating, operating supply voltage range, movement power voltage range, heat radiation characteristics, installation and other product characteristics. Renesas shall have no liability for malfunctions or damages arising out of the use of Renesas products beyond such specified ranges.
10. Although Renesas endeavors to improve the quality and reliability of its products, IC products have specific characteristics such as the occurrence of failure at a certain rate and malfunctions under certain use conditions. Please be sure to implement safety measures to guard against the possibility of physical injury, and injury or damage caused by fire in the event of the failure of a Renesas product, such as safety design for hardware and software including but not limited to redundancy, fire control and malfunction prevention, appropriate treatment for aging degradation or any other applicable measures. Among others, since the evaluation of microcomputer software alone is very difficult, please evaluate the safety of the final products or system manufactured by you.
11. In case Renesas products listed in this document are detached from the products to which the Renesas products are attached or affixed, the risk of accident such as swallowing by infants and small children is very high. You should implement safety measures so that Renesas products may not be easily detached from your products. Renesas shall have no liability for damages arising out of such detachment.
12. This document may not be reproduced or duplicated, in any form, in whole or in part, without prior written approval from Renesas.
13. Please contact a Renesas sales office if you have any questions regarding the information contained in this document, Renesas semiconductor products, or if you have any other inquiries.



RENESAS SALES OFFICES

<http://www.renesas.com>

Refer to "<http://www.renesas.com/en/network>" for the latest and detailed information.

Renesas Technology America, Inc.
450 Holger Way, San Jose, CA 95134-1368, U.S.A
Tel: <1> (408) 382-7500, Fax: <1> (408) 382-7501

Renesas Technology Europe Limited
Dukes Meadow, Millboard Road, Bourne End, Buckinghamshire, SL8 5FH, U.K.
Tel: <44> (1628) 585-100, Fax: <44> (1628) 585-900

Renesas Technology (Shanghai) Co., Ltd.
Unit 204, 205, AZIACenter, No.1233 Lujiazui Ring Rd, Pudong District, Shanghai, China 200120
Tel: <86> (21) 5877-1818, Fax: <86> (21) 6887-7858/7898

Renesas Technology Hong Kong Ltd.
7th Floor, North Tower, World Finance Centre, Harbour City, Canton Road, Tsimshatsui, Kowloon, Hong Kong
Tel: <852> 2265-6688, Fax: <852> 2377-3473

Renesas Technology Taiwan Co., Ltd.
10th Floor, No.99, Fushing North Road, Taipei, Taiwan
Tel: <886> (2) 2715-2888, Fax: <886> (2) 3518-3399

Renesas Technology Singapore Pte. Ltd.
1 Harbour Front Avenue, #06-10, Keppel Bay Tower, Singapore 098632
Tel: <65> 6213-0200, Fax: <65> 6278-8001

Renesas Technology Korea Co., Ltd.
Kukje Center Bldg. 18th Fl., 191, 2-ka, Hangang-ro, Yongsan-ku, Seoul 140-702, Korea
Tel: <82> (2) 796-3115, Fax: <82> (2) 796-2145

Renesas Technology Malaysia Sdn. Bhd
Unit 906, Block B, Menara Amcorp, Amcorp Trade Centre, No.18, Jln Persiaran Barat, 46050 Petaling Jaya, Selangor Darul Ehsan, Malaysia
Tel: <603> 7955-9390, Fax: <603> 7955-9510