

Silicon NPN Power Transistors

2SC3857

DESCRIPTION

- With MT-200 package
- Complement to type 2SA1493

APPLICATIONS

- Audio and general purpose

PINNING(see Fig.2)

PIN	DESCRIPTION
1	Base
2	Collector;connected to mounting base
3	Emitter

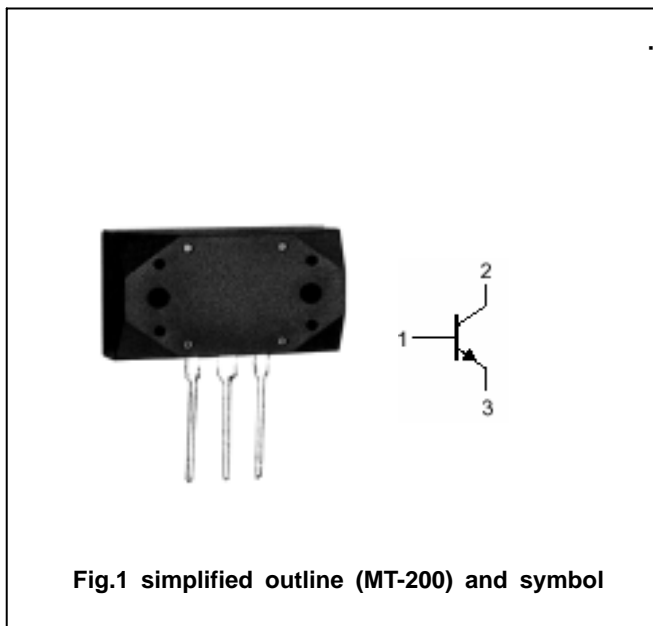

Fig.1 simplified outline (MT-200) and symbol

Absolute maximum ratings(Ta=25)

SYMBOL	PARAMETER	CONDITIONS	VALUE	UNIT
V_{CBO}	Collector-base voltage	Open emitter	200	V
V_{CEO}	Collector-emitter voltage	Open base	200	V
V_{EBO}	Emitter-base voltage	Open collector	6	V
I_C	Collector current		15	A
I_B	Base current		5	A
P_C	Collector power dissipation	$T_C=25$	150	W
T_j	Junction temperature		150	
T_{stg}	Storage temperature		-55~150	

Silicon NPN Power Transistors

2SC3857

CHARACTERISTICS

T_j=25 unless otherwise specified

SYMBOL	PARAMETER	CONDITIONS	MIN	TYP.	MAX	UNIT
V _{(BR)CEO}	Collector-emitter breakdown voltage	I _C =50mA; I _B =0	200			V
V _{CEsat}	Collector-emitter saturation voltage	I _C =10 A; I _B =1 A			3.0	V
I _{CBO}	Collector cut-off current	V _{CB} =200V; I _E =0			100	μ A
I _{EBO}	Emitter cut-off current	V _{EB} =6V; I _C =0			100	μ A
h _{FE}	DC current gain	I _C =5A ; V _{CE} =4V	50		180	
f _T	Transition frequency	I _E =-0.5A ; V _{CE} =12V		20		MHz
C _{OB}	Output capacitance	I _E =0; V _{CB} =10V; f=1MHz		250		pF

Switching times

t _{on}	Turn-on time			0.30		μ s
t _s	Storage time	I _C =5A; R _L =12 I _{B1} =- I _{B2} =0.5A V _{CC} =60V		2.40		μ s
t _f	Fall time			0.40		μ s

◆ h_{FE} classifications

O	P	Y
50-100	70-140	90-180

PACKAGE OUTLINE

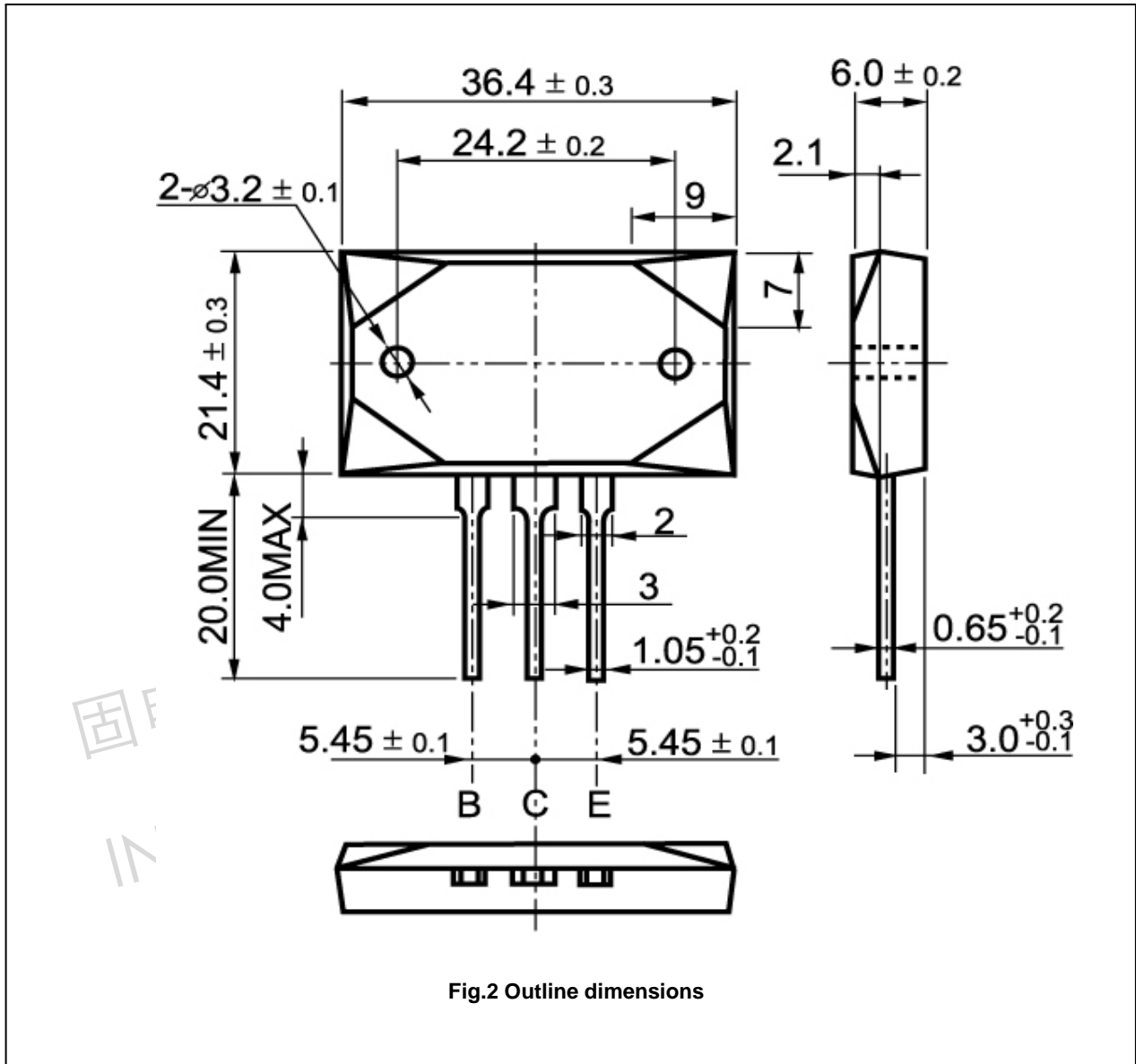

Silicon NPN Power Transistors

2SC3857

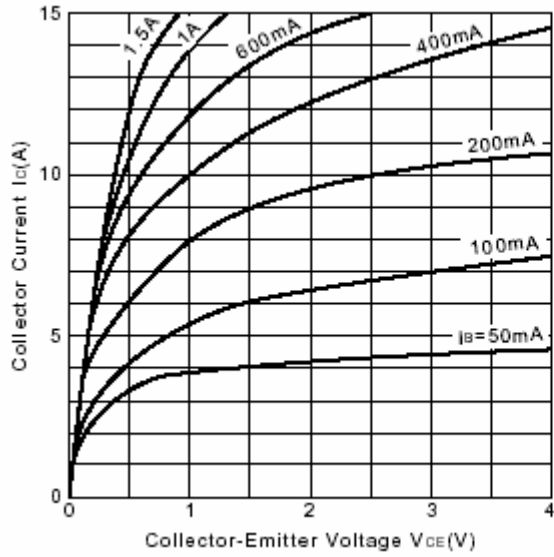

Fig.3 Static Characteristic

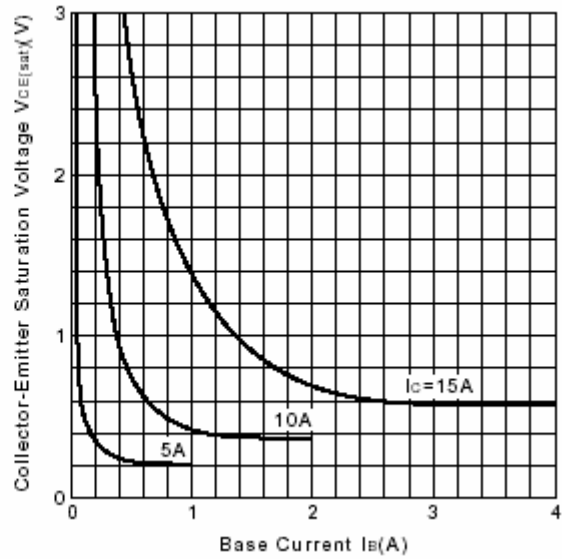

Fig.4 $V_{CE(sat)}-I_B$ Characteristics

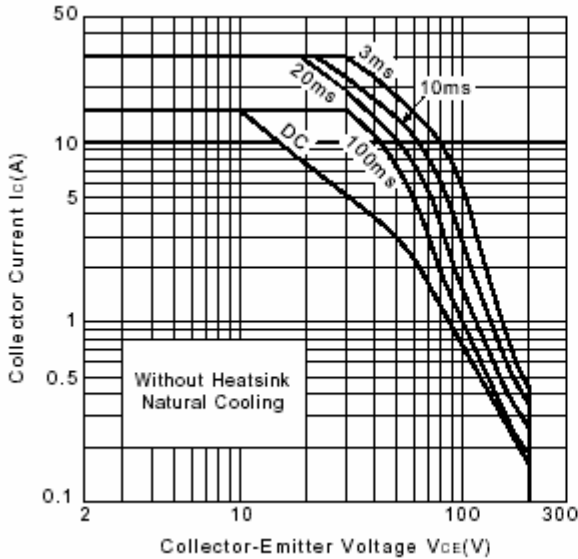

Fig.5 Safe Operating Area

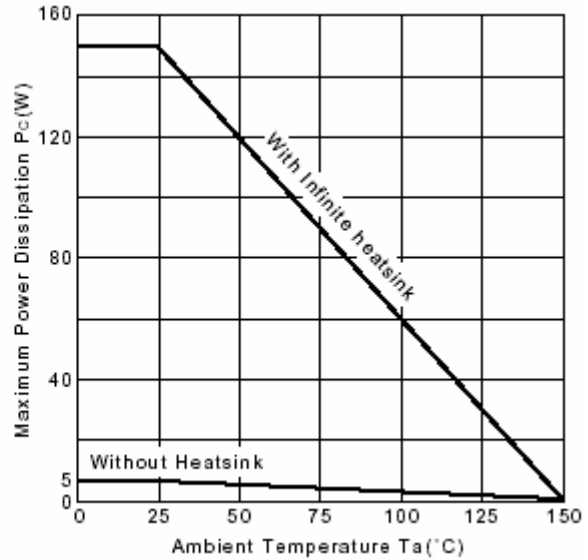

Fig.6 P_c-T_a Derating

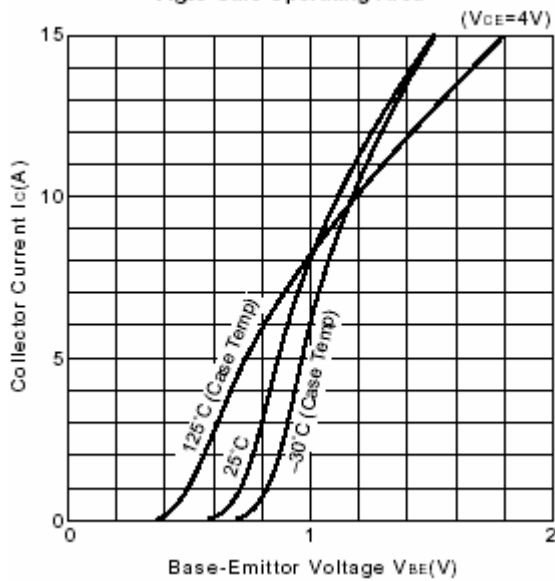

Fig.7 I_c-V_{BE}

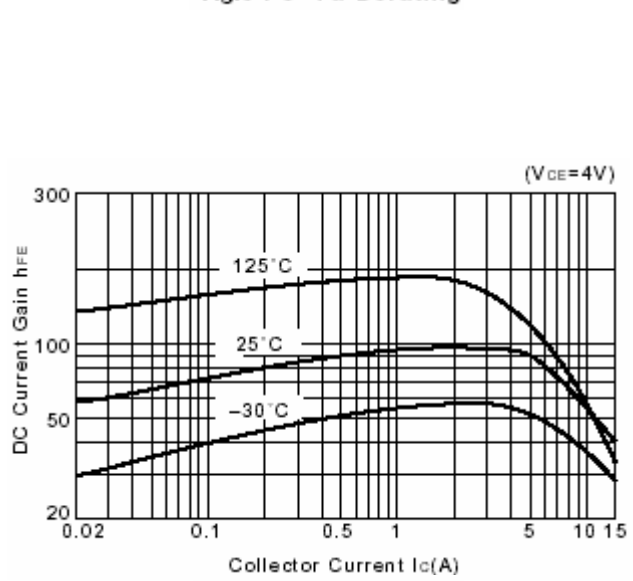

Fig.8 DC current Gain