

RT3YB7M

Composite Transistor
For Muting Application

DESCRIPTION

RT3YB7M is a composite transistor built with RT1P140 and two muting transistor with resistor in SC-88 package.

FEATURE

- RT3YB7M is built in RTr1 side RT1P140, and RTr2, RTr3 side composite muting transistor with resistor.
- Built-in bias resistor RTr1:R1=10k Ω RTr2, RTr3:R1=10k Ω
- Mini package for easy mounting

APPLICATION

muting circuit, switching circuit

OUTLINE DRAWING

Unit: mm

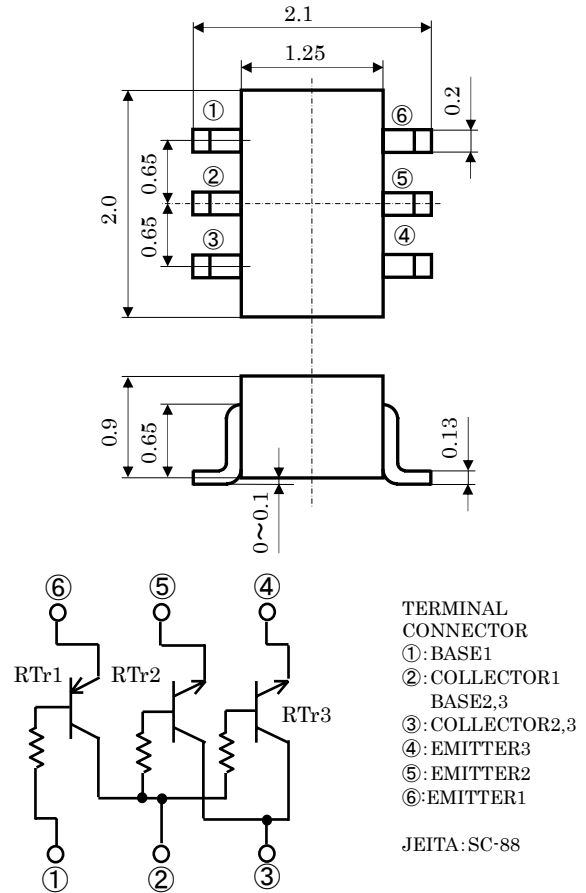

MAXIMUM RATING (Ta=25°C)

SYMBOL	PARAMETER	RTr1 RATING	RTr2, RTr3 RATING	UNIT
VCBO	Collector to Base voltage	-9	40	V
VEBO	Emitter to Base voltage	-50	40	V
VCEO	Collector to Emitter voltage	-9	15	V
IC	Collector current	-100	200	mA
PC(Total)	Collector dissipation (Ta=25°C)	150		mW
Tj	Junction temperature	+150		°C
Tstg	Storage temperature	-55~+150		°C

MARKING

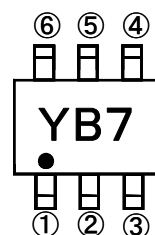

RT3YB7M

Composite Transistor
For Muting Application

Electrical characteristics (Ta=25°C) (RTr1side)

Symbol	Parameter	Test conditions	Limits			Unit
			Min	Typ	Max	
V _{CBO}	Collector-base breakdown voltage	I _C =-50 μA, I _E =0mA	-9			V
V _{EBO}	Emitter-base breakdown voltage	I _E =-50 μA, I _C =0mA	-50			V
V _{CEO}	Collector-emitter breakdown voltage	I _C =-1mA, R _{BE} =∞	-9			V
I _{CBO}	Collector cutoff current	V _{CB} =-6V, I _E =0mA			-0.1	μA
I _{EBO}	Emitter cutoff current	V _{EB} =-50V, I _C =0mA			-0.1	μA
h _{FE}	DC current transfer ratio	V _{CE} =-5V, I _C =-1mA		10		-
R _I	Input resistance	-		10		KΩ

Electrical characteristics (Ta=25°C) (RTr2,RTr3 common)

Symbol	Parameter	Test conditions	Limits			Unit
			Min	Typ	Max	
V _{CBO}	Collector-base breakdown voltage	I _C =50 μA, I _E =0mA	40			V
V _{EBO}	Emitter-base breakdown voltage	I _E =50 μA, I _C =0mA	40			V
V _{CEO}	Collector-emitter breakdown voltage	I _C =1mA, R _{BE} =∞	15			V
I _{CBO}	Collector cutoff current	V _{CB} =40V, I _E =0mA			0.5	μA
I _{EBO}	Emitter cutoff current	V _{EB} =40V, I _C =0mA			0.5	μA
h _{FE}	DC current transfer ratio	V _{CE} =5V, I _C =10mA	820		2500	-
V _{CE(sat)}	Collector-emitter saturation voltage	I _C =50mA, I _E =5mA			100	mV
R _I	Input resistance	-		10		KΩ
f _T	Transition frequency	V _{CE} =6V, I _E =-10mA		55		MHz
R _{on}	Output On-resistance	V _{IN} =3V, f=1MHz		2.0		Ω

TYPICAL CHARACTERISTICS (RT_{r2},RT_{r3})

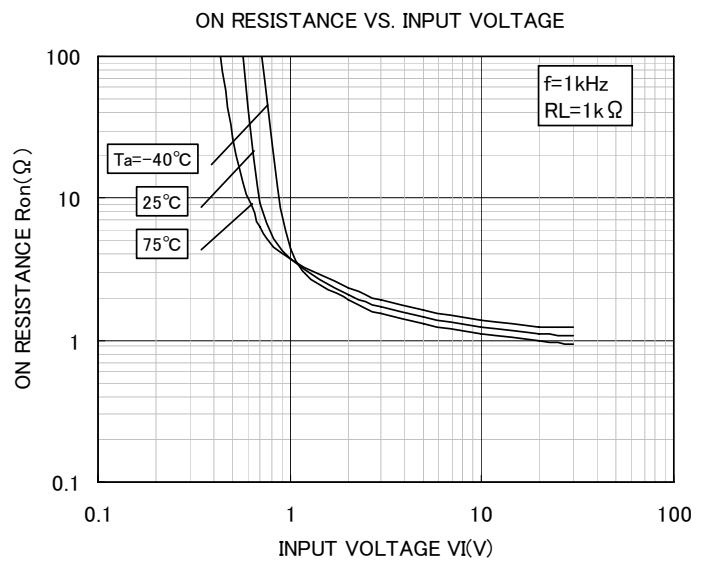
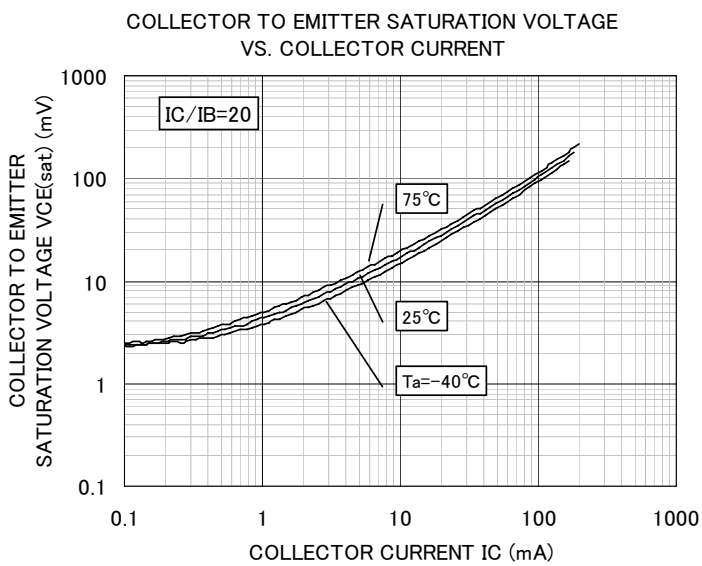
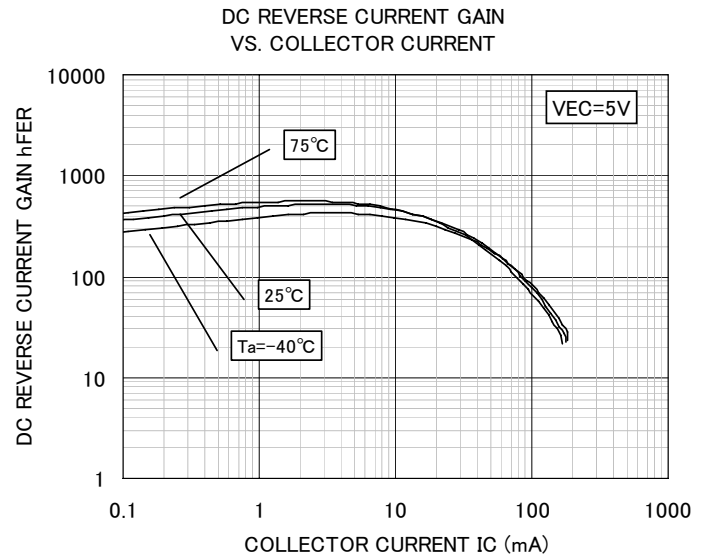
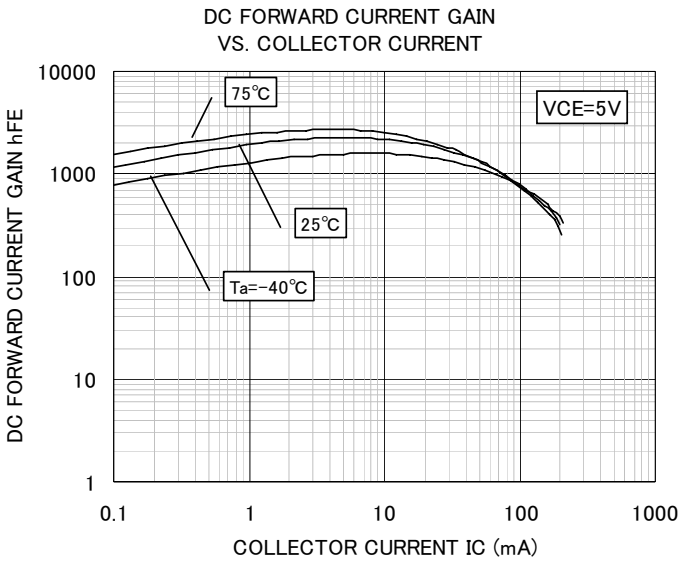
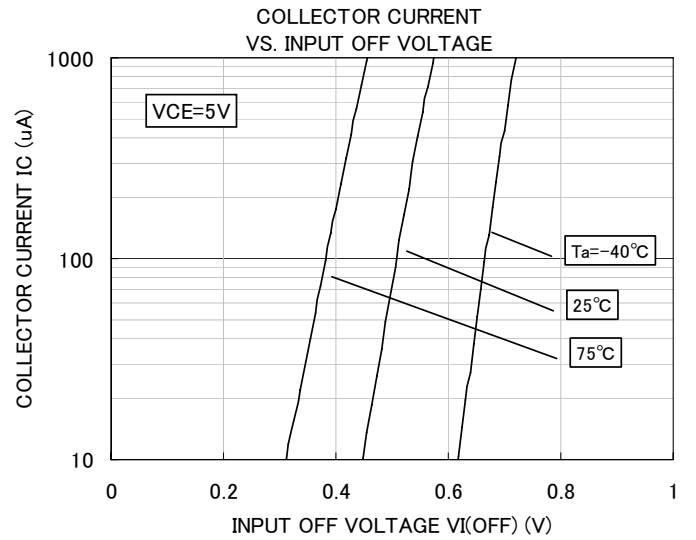
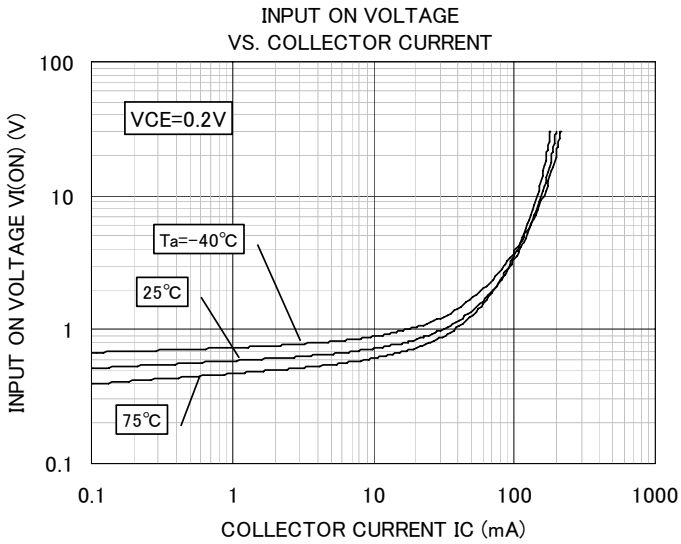



Marketing division, Marketing planning department

6-41 Tsukuba, Isahaya, Nagasaki, 854-0065 Japan

Keep safety first in your circuit designs!

•ISAHAYA Electronics Corporation puts the maximum effort into making semiconductor products better and more reliable, but there is always the possibility that trouble may occur with them. Trouble with semiconductors may lead to personal injury, fire or property damage. Remember to give due consideration to safety when making your circuit designs, with appropriate measures such as (1) placement of substitutive, auxiliary, (2) use of non-flammable material or (3) prevention against any malfunction or mishap.

Notes regarding these materials

- These materials are intended as a reference to our customers in the selection of the ISAHAYA products best suited to the customer's application; they don't convey any license under any intellectual property rights, or any other rights, belonging ISAHAYA or third party.
- ISAHAYA Electronics Corporation assumes no responsibility for any damage, or infringement of any third party's rights, originating in the use of any product data, diagrams, charts or circuit application examples contained in these materials.
- All information contained in these materials, including product data, diagrams and charts, represent information on products at the time of publication of these materials, and are subject to change by ISAHAYA Electronics Corporation without notice due to product improvements or other reasons. It is therefore recommended that customers contact ISAHAYA Electronics Corporation or an authorized ISAHAYA products distributor for the latest product information before purchasing product listed herein.
- ISAHAYA Electronics Corporation products are not designed or manufactured for use in a device or system that is used under circumstances in which human life is potentially at stake. Please contact ISAHAYA electronics corporation or an authorized ISAHAYA products distributor when considering the use of a product contained herein for any specific purposes, such as apparatus or systems for transportation, vehicular, medical, aerospace, nuclear, or undersea repeater use.
- The prior written approval of ISAHAYA Electronics Corporation is necessary to reprint or reproduce in whole or in part these materials.
- If these products or technologies are subject to the Japanese export control restrictions, they must be exported under a license from the Japanese government and cannot be imported into a country other than the approved destination. Any diversion or re-export contrary to the export control laws and regulations of Japan and/or the country of destination is prohibited.
- Please contact ISAHAYA Electronics Corporation or authorized ISAHAYA products distributor for further details on these materials or the products contained therein.