

Silicon NPN Power Transistors

2SC3750

DESCRIPTION

- With TO-220F package
- High breakdown voltage and high reliability.
- Fast switching speed.
- Wide area of safe operation

APPLICATIONS

- 500V/5A switching regulator applications

PINNING

PIN	DESCRIPTION
1	Base
2	Collector
3	Emitter

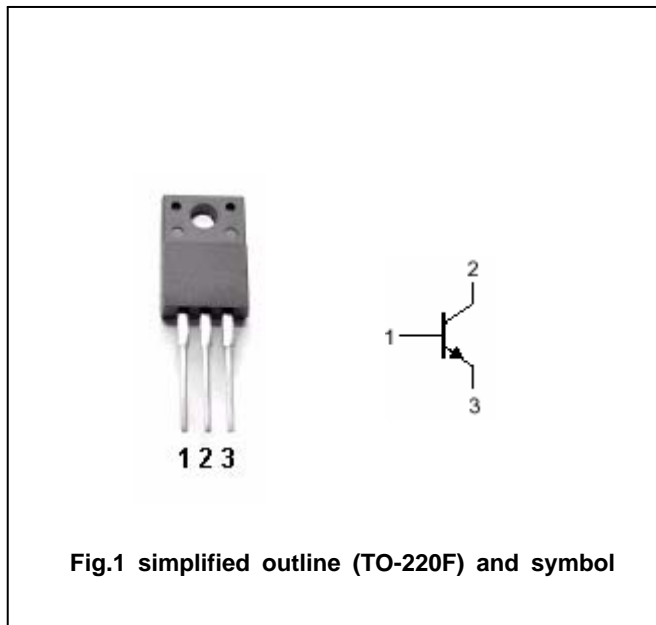

Absolute maximum ratings (Ta=25)

SYMBOL	PARAMETER	CONDITIONS	VALUE	UNIT
V_{CBO}	Collector-base voltage	Open emitter	800	V
V_{CEO}	Collector-emitter voltage	Open base	500	V
V_{EBO}	Emitter-base voltage	Open collector	7	V
I_C	Collector current		5	A
I_{CM}	Collector current-peak		10	A
I_B	Base current		2	A
P_C	Collector dissipation	$T_C=25$	30	W
T_j	Junction temperature		150	
T_{stg}	Storage temperature		-55~150	

Silicon NPN Power Transistors

2SC3750

CHARACTERISTICS

T_j=25 unless otherwise specified

SYMBOL	PARAMETER	CONDITIONS	MIN	TYP.	MAX	UNIT
V _{(BR)CEO}	Collector-emitter breakdown voltage	I _C =5mA ; R _{BE} =	500			V
V _{(BR)CBO}	Collector-base breakdown voltage	I _C =1mA ; I _E =0	800			V
V _{(BR)EBO}	Emitter-base breakdown voltage	I _E =1mA ; I _C =0	7			V
V _{CEsat}	Collector-emitter saturation voltage	I _C =3A ; I _B =0.6A			1.0	V
V _{BEsat}	Base-emitter saturation voltage	I _C =3A ; I _B =0.6A			1.5	V
I _{CBO}	Collector cut-off current	V _{CB} =500V ; I _E =0			10	μA
I _{EBO}	Emitter cut-off current	V _{EB} =5V ; I _C =0			10	μA
h _{FE-1}	DC current gain	I _C =0.6A ; V _{CE} =5V	15		50	
h _{FE-2}	DC current gain	I _C =3A ; V _{CE} =5V	8			
f _T	Transition frequency	I _C =0.6A ; V _{CE} =10V		18		MHz
C _{OB}	Collector output capacitance	f=1MHz ; V _{CB} =10V		80		pF

Switching times

t _{on}	Turn-on time	I _C =4A ; I _{B1} =0.8A ; I _{B2} =-1.6A V _{CC} =200V , R _L =50			0.5	μs
t _{stg}	Storage time				3.0	μs
t _f	Fall time				0.3	μs

◆ h_{FE-1} Classifications

L	M	N
15-30	20-40	30-50

Silicon NPN Power Transistors

2SC3750

PACKAGE OUTLINE

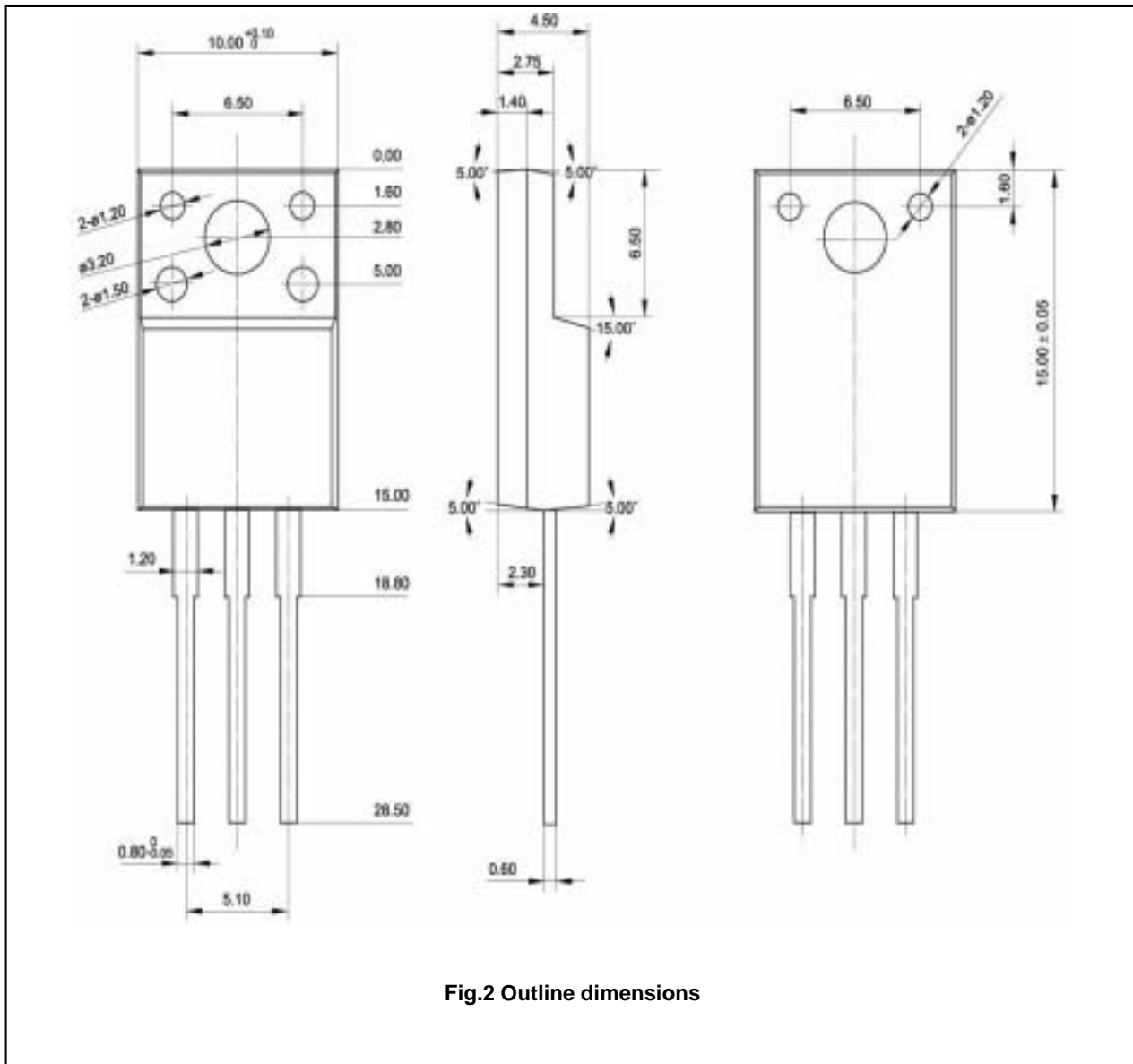

Fig.2 Outline dimensions

Silicon NPN Power Transistors

2SC3750

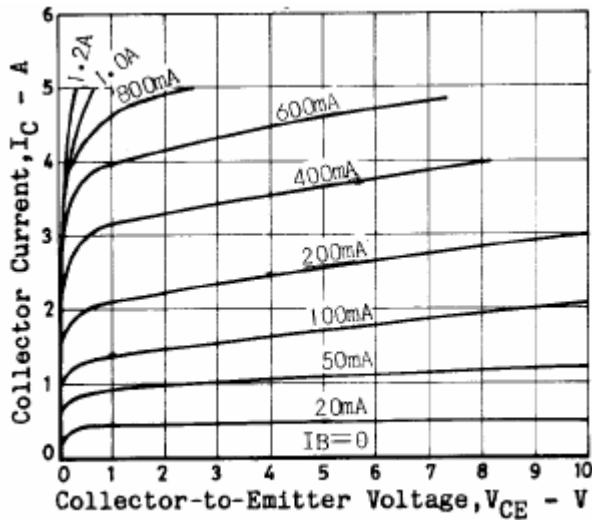

Fig.3 Static Characteristic

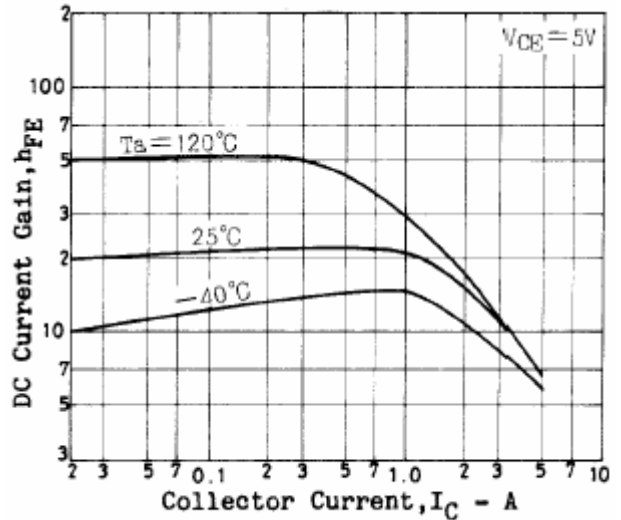

Fig.4 DC current Gain

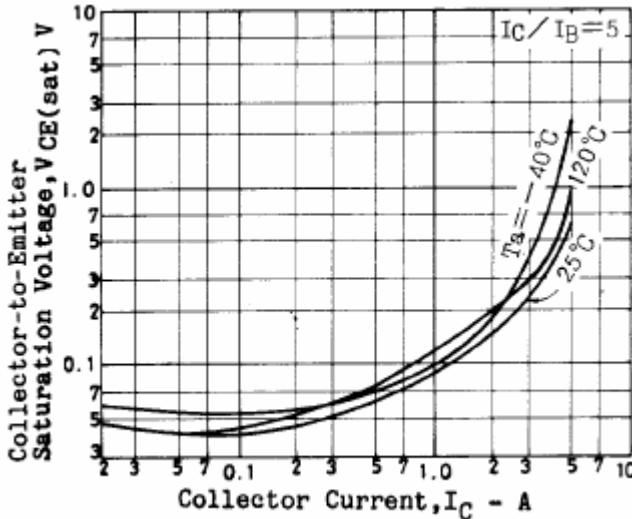

Fig.5 Collector-Emitter Saturation Voltage

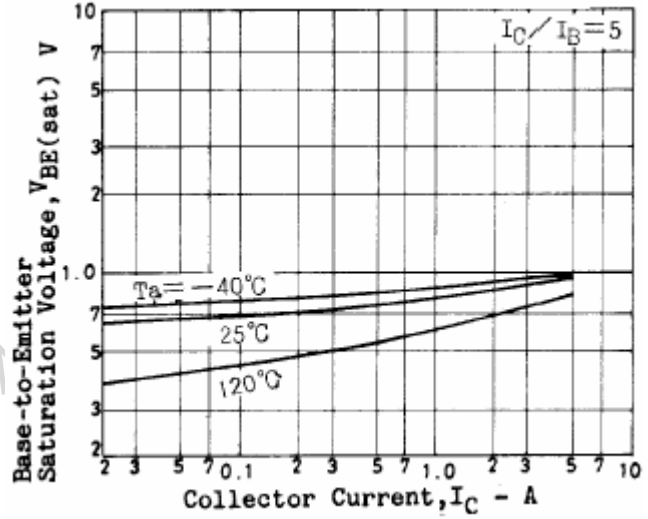

Fig.6 Base-Emitter Saturation Voltage

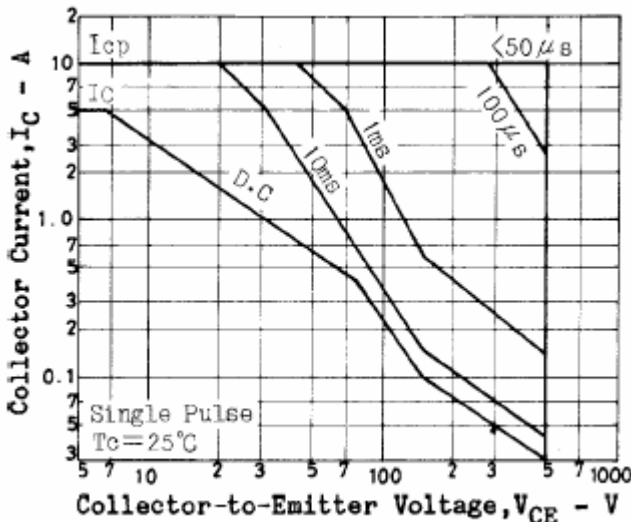

Fig.7 Safe Operating Area