



**Vorläufig
Preliminary**

Elektrische Eigenschaften / Electrical properties

Höchstzulässige Werte / Maximum rated values

Diode Gleichrichter/ Diode Rectifier

Periodische Rückw. Spitzensperrspannung repetitive peak reverse voltage	$T_{vj} = 25^{\circ}\text{C}$	V_{RRM}	800	V
Durchlaßstrom Grenzeffektivwert pro Chip RMS forward current per chip	$T_C = 80^{\circ}\text{C}$	I_{FRMSM}	58	A
Gleichrichter Ausgang Grenzeffektivstrom maximum RMS current at Rectifier output	$T_C = 80^{\circ}\text{C}$	I_{RMSmax}	96	A
Stoßstrom Grenzwert surge forward current	$t_p = 10\text{ ms}, T_{vj} = 25^{\circ}\text{C}$	I_{FSM}	448	A
	$t_p = 10\text{ ms}, T_{vj} = 150^{\circ}\text{C}$		358	A
Grenzlastintegral i^2t - value	$t_p = 10\text{ ms}, T_{vj} = 25^{\circ}\text{C}$	I^2t	1000	A^2s
	$t_p = 10\text{ ms}, T_{vj} = 150^{\circ}\text{C}$		642	A^2s

Transistor Wechselrichter/ Transistor Inverter

Kollektor-Emitter-Sperrspannung collector-emitter voltage	$T_{vj} = 25^{\circ}\text{C}$	V_{CES}	600	V
Kollektor-Dauergleichstrom DC-collector current	$T_C = 65^{\circ}\text{C}$	$I_{C,nom.}$	20	A
	$T_C = 25^{\circ}\text{C}$	I_C	25	A
Periodischer Kollektor Spitzenstrom repetitive peak collector current	$t_p = 1\text{ ms}, T_C = 65^{\circ}\text{C}$	I_{CRM}	40	A
Gesamt-Verlustleistung total power dissipation	$T_C = 25^{\circ}\text{C}$	P_{tot}	80	W
Gate-Emitter-Spitzenspannung gate-emitter peak voltage		V_{GES}	+/- 20V	V

Diode Wechselrichter/ Diode Inverter

Dauergleichstrom DC forward current		I_F	20	A
Periodischer Spitzenstrom repetitive peak forw. current	$t_p = 1\text{ ms}$	I_{FRM}	40	A
Grenzlastintegral i^2t - value	$V_R = 0\text{V}, t_p = 10\text{ms}, T_{vj} = 125^{\circ}\text{C}$	I^2t	62	A^2s

prepared by: Thomas Passe	date of publication: 2002-02-27
approved by: Ingo Graf	revision: 5

Technische Information / Technical Information

eupec

IGBT-Module
IGBT-Modules

FB20R06KL4



**Vorläufig
Preliminary**

Modul Isolation/ Module Isolation

Isolations-Prüfspannung insulation test voltage	RMS, f = 50 Hz, t = 1 min. NTC connected to Baseplate	V_{ISOL}	2,5	kV
--	--	------------	-----	----

Elektrische Eigenschaften / Electrical properties

Charakteristische Werte / Characteristic values

Diode Gleichrichter/ Diode Rectifier		min. typ. max.				
Durchlaßspannung forward voltage	$T_{vj} = 150^{\circ}\text{C}$, $I_F = 20\text{ A}$	V_F	-	0,85	-	V
Schleusenspannung threshold voltage	$T_{vj} = 150^{\circ}\text{C}$	$V_{(TO)}$	-	0,63	-	V
Ersatzwiderstand slope resistance	$T_{vj} = 150^{\circ}\text{C}$	r_T	-	10	-	m Ω
Sperrstrom reverse current	$T_{vj} = 150^{\circ}\text{C}$, $V_R = 800\text{ V}$	I_R	-	5	-	mA
Modul Leitungswiderstand, Anschlüsse-Chip lead resistance, terminals-chip	$T_C = 25^{\circ}\text{C}$	R_{AA+CC}	-	4	-	m Ω
Transistor Wechselrichter/ Transistor Inverter		min. typ. max.				
Kollektor-Emitter Sättigungsspannung collector-emitter saturation voltage	$V_{GE} = 15\text{ V}$, $T_{vj} = 25^{\circ}\text{C}$, $I_C = 20\text{ A}$	$V_{CE\text{ sat}}$	-	1,95	2,55	V
	$V_{GE} = 15\text{ V}$, $T_{vj} = 125^{\circ}\text{C}$, $I_C = 20\text{ A}$		-	2,2	-	V
Gate-Schwellenspannung gate threshold voltage	$V_{CE} = V_{GE}$, $T_{vj} = 25^{\circ}\text{C}$, $I_C = 0,5\text{ mA}$	$V_{GE(TO)}$	4,5	5,5	6,5	V
Eingangskapazität input capacitance	f = 1MHz, $T_{vj} = 25^{\circ}\text{C}$ $V_{CE} = 25\text{ V}$, $V_{GE} = 0\text{ V}$	C_{ies}	-	1,1	-	nF
Kollektor-Emitter Reststrom collector-emitter cut-off current	$V_{GE} = 0\text{ V}$, $T_{vj} = 125^{\circ}\text{C}$, $V_{CE} = 600\text{ V}$	I_{CES}	-	5,0	-	mA
Gate-Emitter Reststrom gate-emitter leakage current	$V_{CE} = 0\text{ V}$, $V_{GE} = 20\text{ V}$, $T_{vj} = 25^{\circ}\text{C}$	I_{GES}	-	-	400	nA
Einschaltverzögerungszeit (ind. Last) turn on delay time (inductive load)	$I_C = I_{Nenn}$, $V_{CC} = 300\text{ V}$ $V_{GE} = \pm 15\text{ V}$, $T_{vj} = 25^{\circ}\text{C}$, $R_G = 47\text{ Ohm}$	$t_{d,on}$	-	22	-	ns
	$V_{GE} = \pm 15\text{ V}$, $T_{vj} = 125^{\circ}\text{C}$, $R_G = 47\text{ Ohm}$			31		
Anstiegszeit (induktive Last) rise time (inductive load)	$I_C = I_{Nenn}$, $V_{CC} = 300\text{ V}$ $V_{GE} = \pm 15\text{ V}$, $T_{vj} = 25^{\circ}\text{C}$, $R_G = 47\text{ Ohm}$	t_r	-	23	-	ns
	$V_{GE} = \pm 15\text{ V}$, $T_{vj} = 125^{\circ}\text{C}$, $R_G = 47\text{ Ohm}$			37		
Abschaltverzögerungszeit (ind. Last) turn off delay time (inductive load)	$I_C = I_{Nenn}$, $V_{CC} = 300\text{ V}$ $V_{GE} = \pm 15\text{ V}$, $T_{vj} = 25^{\circ}\text{C}$, $R_G = 47\text{ Ohm}$	$t_{d,off}$	-	143	-	ns
	$V_{GE} = \pm 15\text{ V}$, $T_{vj} = 125^{\circ}\text{C}$, $R_G = 47\text{ Ohm}$			154		
Fallzeit (induktive Last) fall time (inductive load)	$I_C = I_{Nenn}$, $V_{CC} = 300\text{ V}$ $V_{GE} = \pm 15\text{ V}$, $T_{vj} = 25^{\circ}\text{C}$, $R_G = 47\text{ Ohm}$	t_f	-	22	-	ns
	$V_{GE} = \pm 15\text{ V}$, $T_{vj} = 125^{\circ}\text{C}$, $R_G = 47\text{ Ohm}$			38		
Einschaltverlustenergie pro Puls turn-on energy loss per pulse	$I_C = I_{Nenn}$, $V_{CC} = 300\text{ V}$ $V_{GE} = \pm 15\text{ V}$, $T_{vj} = 125^{\circ}\text{C}$, $R_G = 47\text{ Ohm}$ $L_S = 80\text{ nH}$	E_{on}	-	0,73	-	mWs
Abschaltverlustenergie pro Puls turn-off energy loss per pulse	$I_C = I_{Nenn}$, $V_{CC} = 300\text{ V}$ $V_{GE} = \pm 15\text{ V}$, $T_{vj} = 125^{\circ}\text{C}$, $R_G = 47\text{ Ohm}$ $L_S = 80\text{ nH}$	E_{off}	-	0,56	-	mWs
Kurzschlußverhalten SC Data	$t_P \leq 10\mu\text{s}$, $V_{GE} \leq 15\text{ V}$, $R_G = 47\text{ Ohm}$ $T_{vj} \leq 125^{\circ}\text{C}$, $V_{CC} = 360\text{ V}$	I_{SC}	-	80	-	A



Vorläufig
Preliminary

Elektrische Eigenschaften / Electrical properties

Charakteristische Werte / Characteristic values

		min. typ. max.				
Modulinduktivität stray inductance module		$L_{\sigma CE}$	-	-	40	nH
Modul Leitungswiderstand, Anschlüsse-Chip lead resistance, terminals-chip	$T_C = 25^\circ C$	R_{CC+EE}	-	13	-	m Ω

Diode Wechselrichter/ Diode Inverter		min. typ. max.				
Durchlaßspannung forward voltage	$V_{GE} = 0V, T_{vj} = 25^\circ C, I_F = 20 A$ $V_{GE} = 0V, T_{vj} = 125^\circ C, I_F = 20 A$	V_F	-	1,7	2,15	V
Rückstromspitze peak reverse recovery current	$I_F = I_{Nenn}, - di_F/dt = 1000 A/us$ $V_{GE} = -10V, T_{vj} = 25^\circ C, V_R = 300 V$ $V_{GE} = -10V, T_{vj} = 125^\circ C, V_R = 300 V$	I_{RM}	-	20	-	A
Sperrverzögerungsladung recovered charge	$I_F = I_{Nenn}, - di_F/dt = 1000 A/us$ $V_{GE} = -10V, T_{vj} = 25^\circ C, V_R = 300 V$ $V_{GE} = -10V, T_{vj} = 125^\circ C, V_R = 300 V$	Q_r	-	1	-	μAs
Abschaltenergie pro Puls reverse recovery energy	$I_F = I_{Nenn}, - di_F/dt = 1000 A/us$ $V_{GE} = -10V, T_{vj} = 25^\circ C, V_R = 300 V$ $V_{GE} = -10V, T_{vj} = 125^\circ C, V_R = 300 V$	E_{rec}	-	0,2	-	mWs
			-	0,35	-	mWs

NTC-Widerstand/ NTC-Thermistor		min. typ. max.				
Nennwiderstand	$T_C = 25^\circ C$	R_{25}	-	5	-	k Ω
Abweichung von R_{100} deviation of R_{100}	$T_C = 100^\circ C, R_{100} = 493 \Omega$	$\Delta R/R$	-5		5	%
Verlustleistung power dissipation	$T_C = 25^\circ C$	P_{25}			20	mW
B-Wert B-value	$R_2 = R_1 \exp [B(1/T_2 - 1/T_1)]$	$B_{25/50}$		3375		K

Technische Information / Technical Information

IGBT-Module
IGBT-Modules

FB20R06KL4

eupec



**Vorläufig
Preliminary**

Thermische Eigenschaften / Thermal properties

				min.	typ.	max.	
Innerer Wärmewiderstand thermal resistance, junction to heatsink	Gleichr. Diode/ Rectif. Diode $\lambda_{\text{paste}}=1\text{W/m}^2\text{K}$	R_{thJH}	-	1,1	-	K/W	
	Trans. Wechr./ Trans. Inverter $\lambda_{\text{grease}}=1\text{W/m}^2\text{K}$		-	1,8	-	K/W	
	Diode Wechr./ Diode Inverter		-	3,7	-	K/W	
Innerer Wärmewiderstand thermal resistance, junction to case	Gleichr. Diode/ Rectif. Diode	R_{thJC}	-	-	1	K/W	
	Trans. Wechr./ Trans. Inverter		-	-	1,6	K/W	
	Diode Wechr./ Diode Inverter		-	-	2,7	K/W	
Übergangs-Wärmewiderstand thermal resistance, case to heatsink	Gleichr. Diode/ Rectif. Diode $\lambda_{\text{paste}}=1\text{W/m}^2\text{K}$	R_{thCH}	-	0,2	-	K/W	
	Trans. Wechr./ Trans. Inverter $\lambda_{\text{grease}}=1\text{W/m}^2\text{K}$		-	0,4	-	K/W	
	Diode Wechr./ Diode Inverter		-	1,3	-	K/W	
Höchstzulässige Sperrschichttemperatur maximum junction temperature		T_{vj}	-	-	150	°C	
Betriebstemperatur operation temperature		T_{op}	-40	-	125	°C	
Lagertemperatur storage temperature		T_{stg}	-40	-	125	°C	

Mechanische Eigenschaften / Mechanical properties

Innere Isolation internal insulation				Al_2O_3	
CTI comperative tracking index				225	
Anpreßkraft f. mech. Befestigung pro Feder mounting force per clamp		F		40...80	N
Gewicht weight		G		36	g
Kontakt - Kühlkörper terminal to heatsink	Kriechstrecke creeping distance			13,5	mm
	Luftstrecke clearance			12	mm
Terminal - Terminal terminal to terminal	Kriechstrecke creeping distance			7,5	mm
	Luftstrecke clearance			7,5	mm



Vorläufig
Preliminary

Ausgangskennlinienfeld Wechselr. (typisch) $I_C = f(V_{CE})$
Output characteristic Inverter (typical) $V_{GE} = 15\text{ V}$

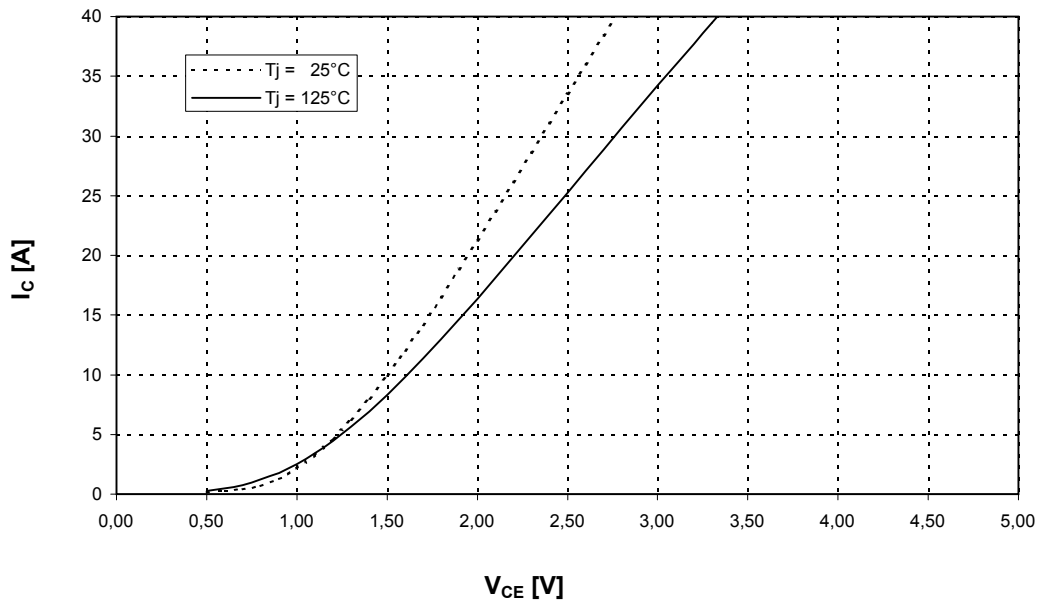

Ausgangskennlinienfeld Wechselr. (typisch) $I_C = f(V_{CE})$
Output characteristic Inverter (typical) $T_{vj} = 125^\circ\text{C}$

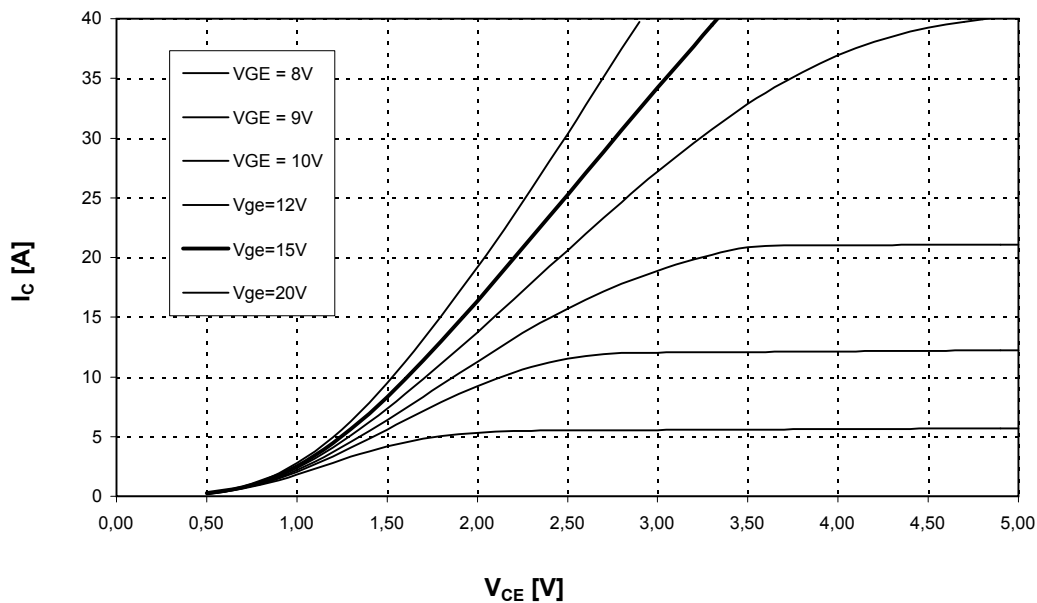



Vorläufig
Preliminary

Übertragungscharakteristik Wechselr. (typisch)
Transfer characteristic Inverter (typical)

$I_C = f(V_{GE})$
 $V_{CE} = 20\text{ V}$

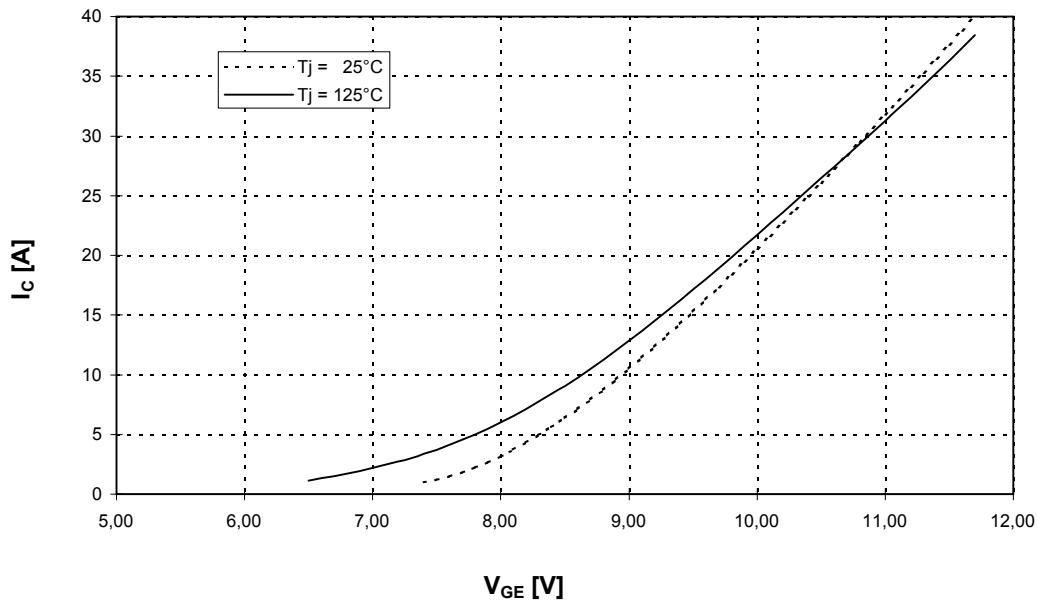

Durchlaßkennlinie der Freilaufdiode Wechselr. (typisch) $I_F = f(V_F)$
Forward characteristic of FWD Inverter (typical)

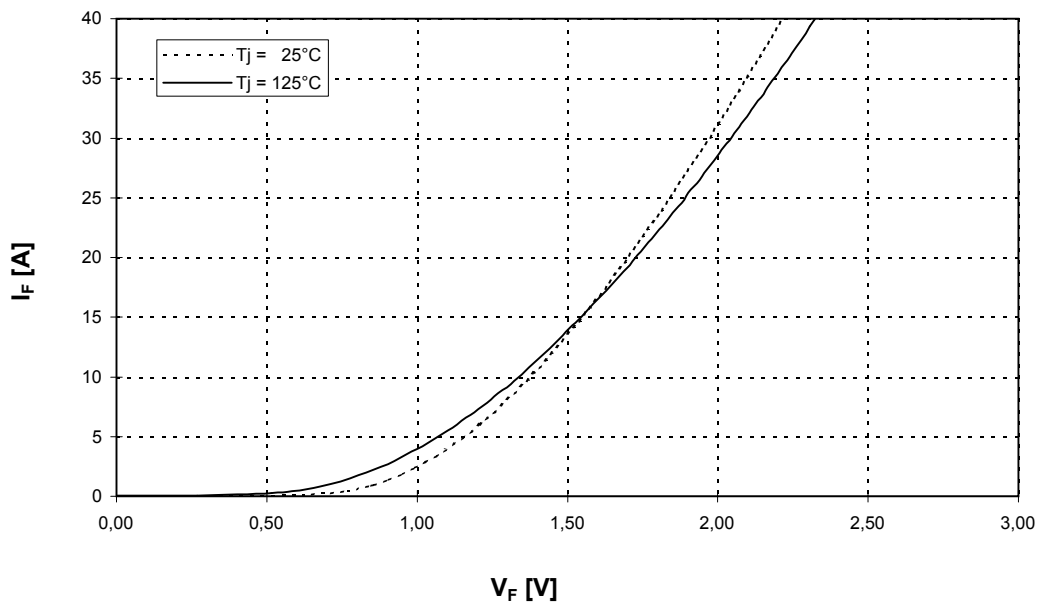



Vorläufig
Preliminary

Schaltverluste Wechselr. (typisch) $E_{on} = f(I_C), E_{off} = f(I_C), E_{rec} = f(I_C)$ $V_{CC} = 300\text{ V}$
 Switching losses Inverter (typical) $T_j = 125^\circ\text{C}, V_{GE} = \pm 15\text{ V}, R_{Gon} = R_{Goff} = 47\text{ Ohm}$

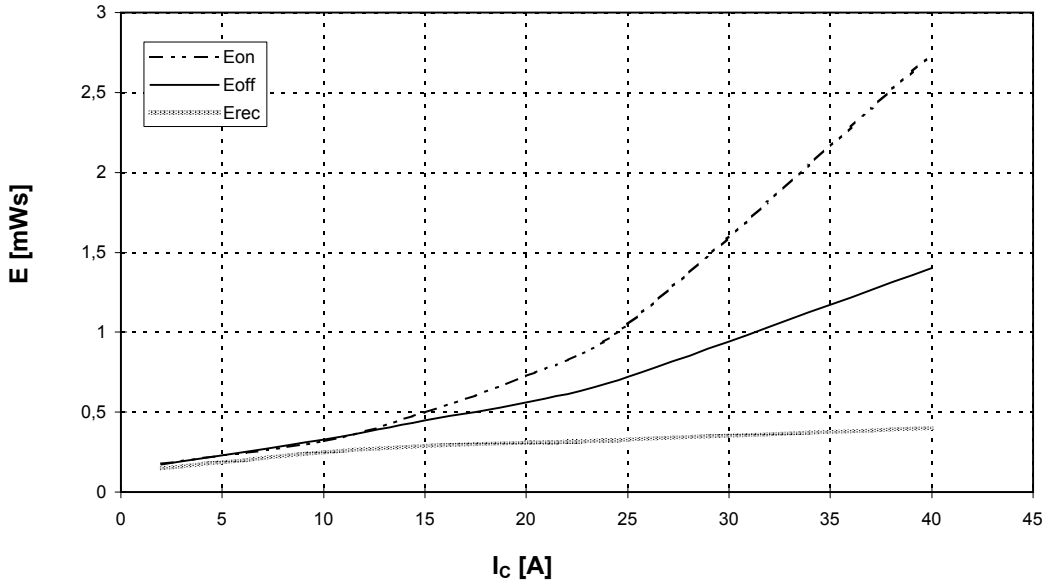

Schaltverluste Wechselr. (typisch) $E_{on} = f(R_G), E_{off} = f(R_G), E_{rec} = f(R_G)$
 Switching losses Inverter (typical) $T_j = 125^\circ\text{C}, V_{GE} = \pm 15\text{ V}, I_C = I_{nenn}, V_{CC} = 300\text{ V}$

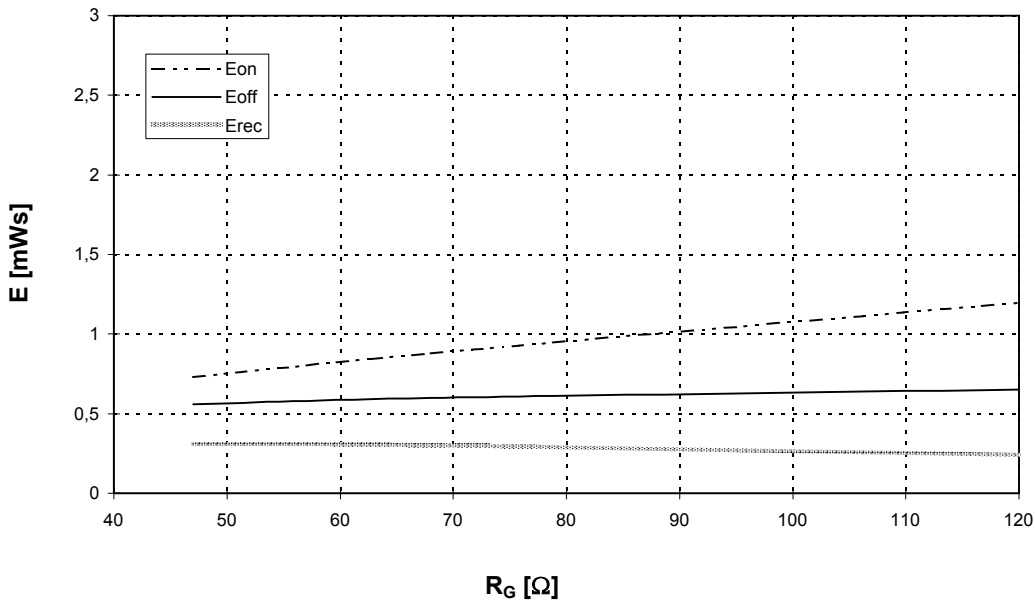



Vorläufig
Preliminary

Transienter Wärmewiderstand Wechsell. $Z_{thJH} = f(t)$
Transient thermal impedance Inverter

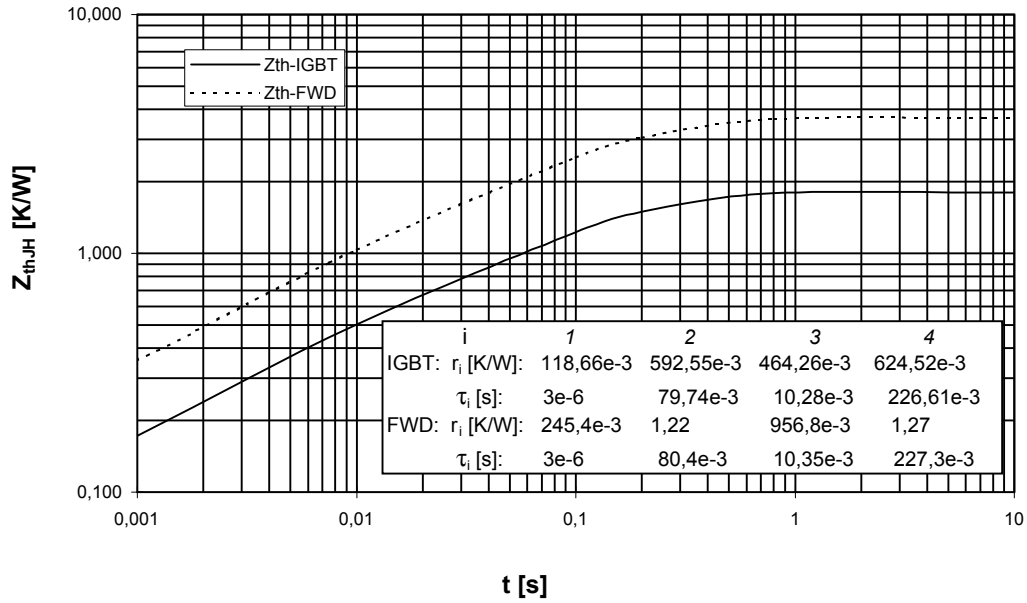

Sicherer Arbeitsbereich Wechsell. (RBSOA) $I_C = f(V_{CE})$
Reverse bias safe operating area Inverter (RBSOA) $T_{vj} = 125^\circ\text{C}$, $V_{GE} = \pm 15\text{V}$, $R_G = 47 \text{ Ohm}$

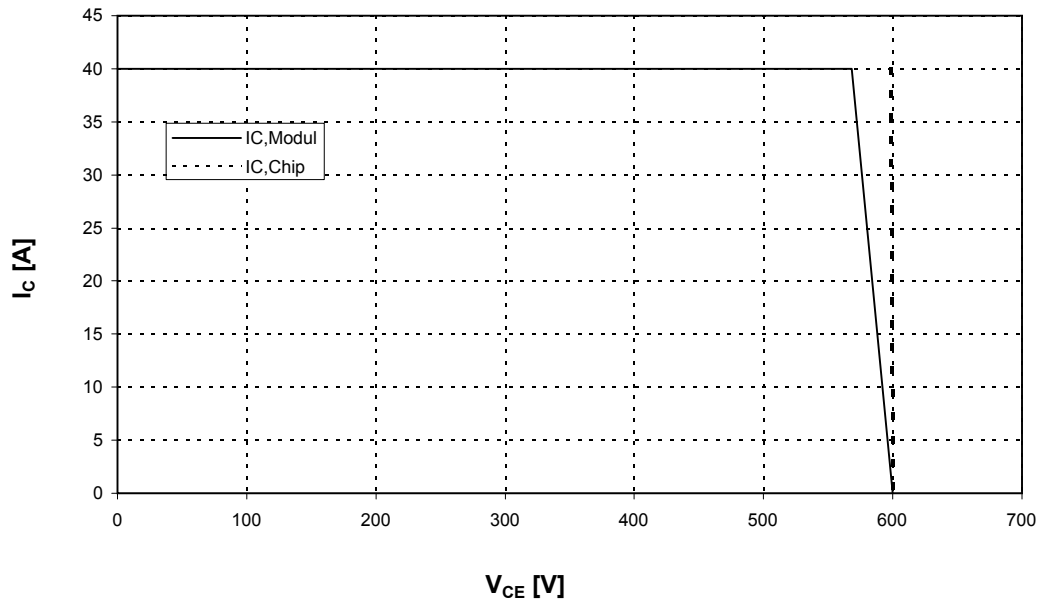



Vorläufig
Preliminary

Durchlaßkennlinie der Gleichrichterdiode (typisch) $I_F = f(V_F)$
Forward characteristic of Rectifier Diode (typical)

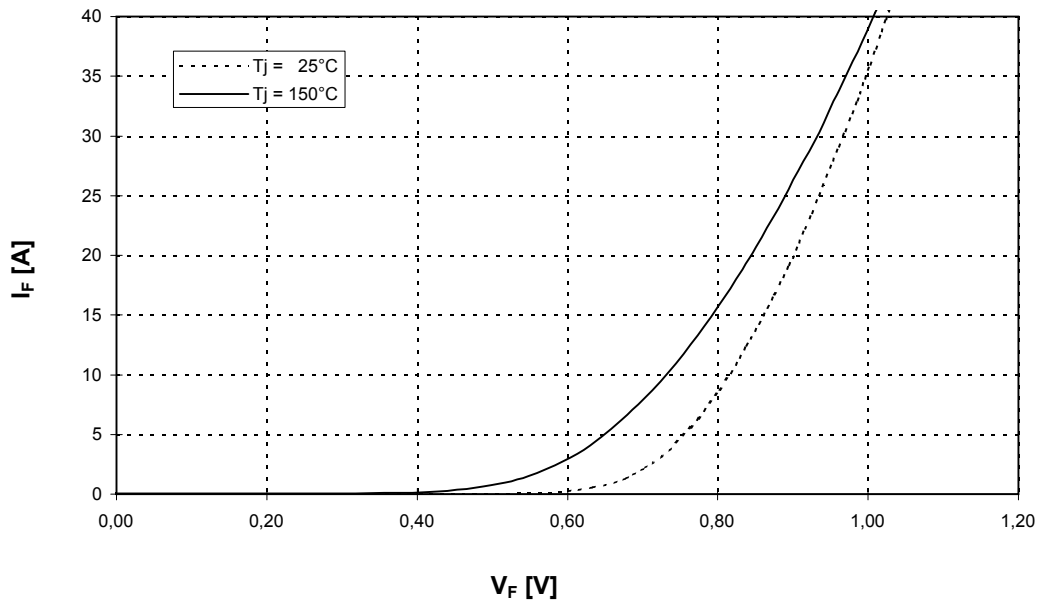

NTC- Temperaturkennlinie (typisch) $R = f(T)$
NTC- temperature characteristic (typical)

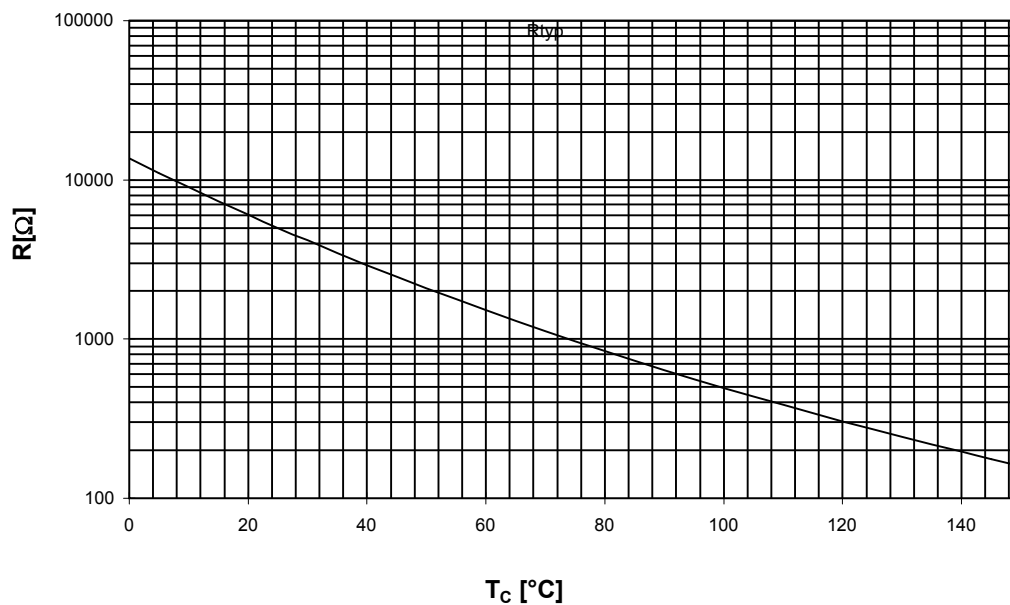



**Vorläufig
Preliminary**

Schaltplan/ Circuit diagram

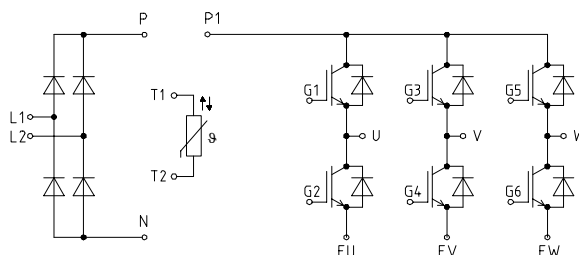

Gehäuseabmessungen/ Package outlines

Modul only designed for mounting on PCB's with 1.6 ±0.2 mm thickness

Pinpositions with tolerance $\varnothing 0.4$

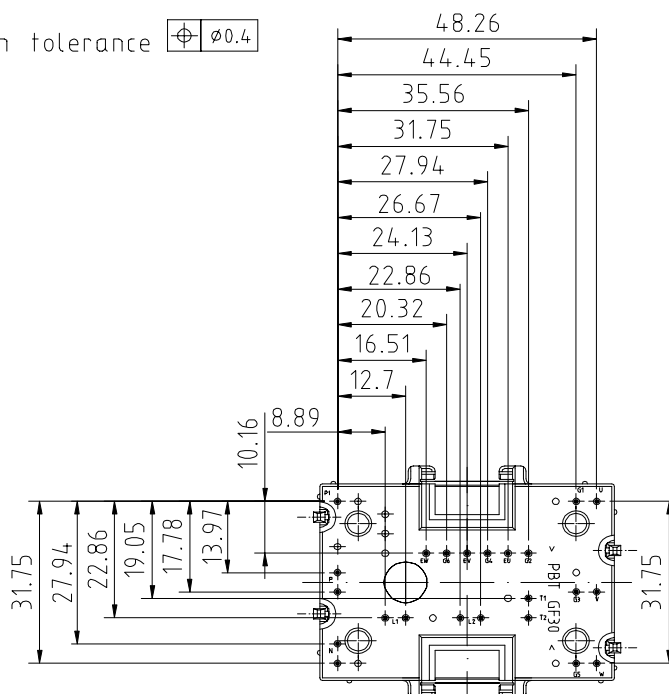

Bohrplan /
drilling layout

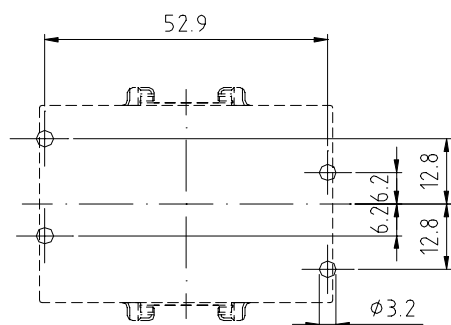



Gehäuseabmessungen Forts. / Package outlines contd.

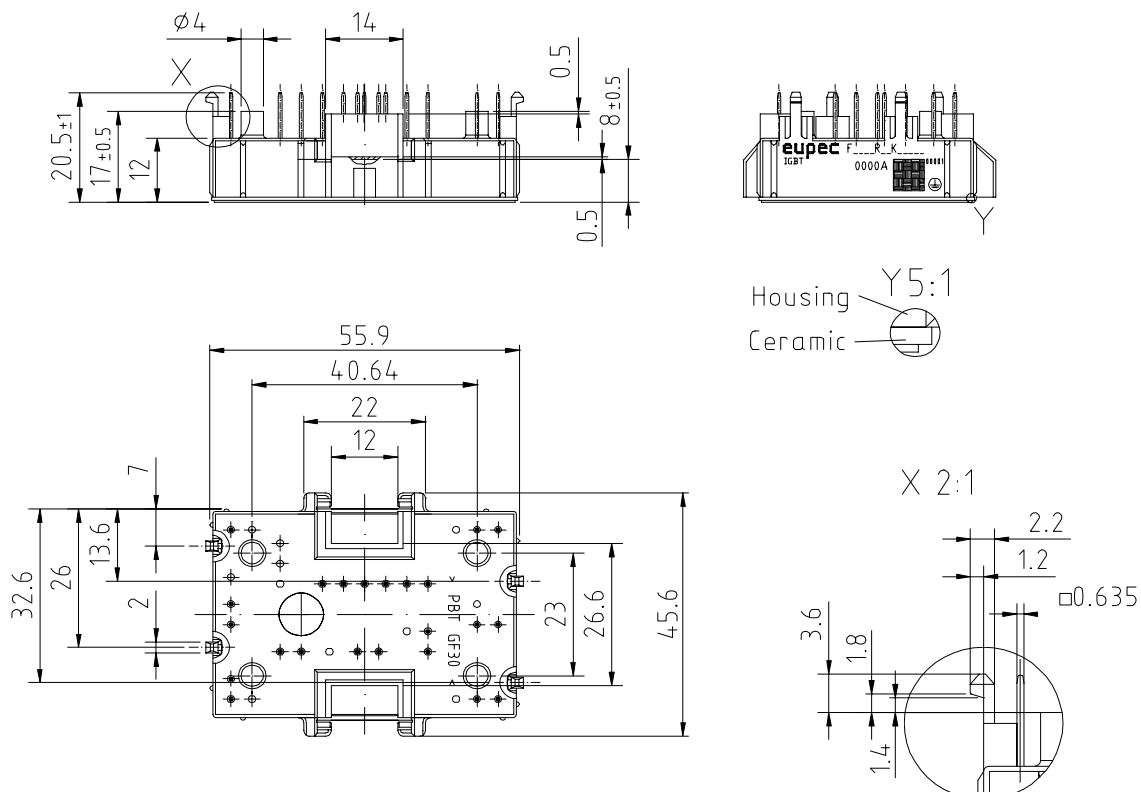

Mit dieser technischen Information werden Halbleiterbauelemente spezifiziert, jedoch keine Eigenschaften zugesichert. Diese gilt in Verbindung mit den zugehörigen Technischen Erläuterungen.

This technical information specifies semiconductor devices but promises no characteristics. It is valid in combination with the belonging technical notes.

Terms & Conditions of Usage

Attention

The present product data is exclusively subscribed to technically experienced staff. This Data Sheet is describing the specification of the products for which a warranty is granted exclusively pursuant the terms and conditions of the supply agreement. There will be no guarantee of any kind for the product and its specifications. Changes to the Data Sheet are reserved.

You and your technical departments will have to evaluate the suitability of the product for the intended application and the completeness of the product data with respect to such application. Should you require product information in excess of the data given in the Data Sheet, please contact your local Sales Office via "www.eupec.com / sales & contact".

Warning

Due to technical requirements the products may contain dangerous substances. For information on the types in question please contact your local Sales Office via "www.eupec.com / sales & contact".