

RoHS Compliant Product

Description

The SSD01N60 provide the designer with the best combination of fast switching.

The TO-252 is universally preferred for all commercial-industrial surface mount applications and suited for AC/DC converters.

Features

- * Dynamic dv/dt Rating
- * Simple Drive Requirement
- * Fast Switching
- * Repetitive Avalanche Rated

TO-252

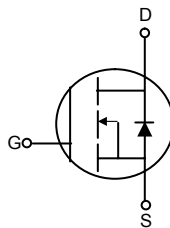
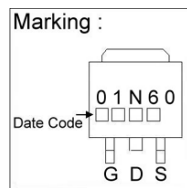
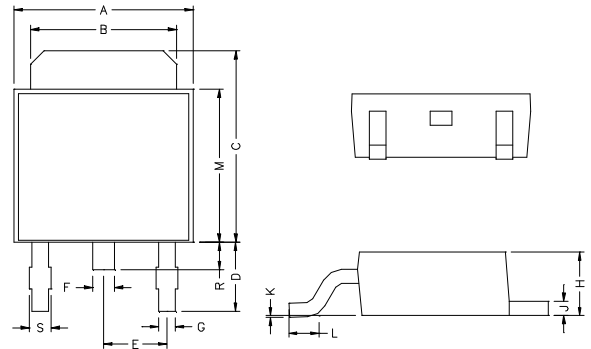

REF.	Millimeter		REF.	Millimeter	
	Min.	Max.		Min.	Max.
A	6.40	6.80	G	0.50	0.70
B	5.20	5.50	H	2.20	2.40
C	6.80	7.20	J	0.45	0.55
D	2.20	2.80	K	0	0.15
E	2.30 REF.		L	0.90	1.50
F	0.70	0.90	M	5.40	5.80
S	0.60	0.90	R	0.80	1.20

Absolute Maximum Ratings

Parameter	Symbol	Ratings	Unit
Drain-Source Voltage	V_{DS}	600	V
Gate-Source Voltage	V_{GS}	± 20	V
Continuous Drain Current, $V_{GS}@10V$	$I_D@T_C=25^\circ C$	1.6	A
Continuous Drain Current, $V_{GS}@10V$	$I_D@T_C=100^\circ C$	1	A
Pulsed Drain Current ¹	I_{DM}	6	A
Total Power Dissipation	$P_D@T_C=25^\circ C$	39	W
Linear Derating Factor		0.31	W/ $^\circ C$
Single Pulse Avalanche Energy ²	E_{AS}	13	mJ
Avalanche Current	I_{AR}	1.6	A
Repetitive Avalanche Energy	E_{AR}	0.5	mJ
Operating Junction and Storage Temperature Range	T_j, T_{stg}	-55~+150	$^\circ C$

Thermal Data

Parameter	Symbol	Ratings	Unit
Thermal Resistance Junction-case	R_{thj-c}	3.2	$^\circ C/W$
Thermal Resistance Junction-ambient	R_{thj-a}	110	$^\circ C/W$

Electrical Characteristics(T_j=25°C Unless otherwise specified)

Parameter	Symbol	Min.	Typ.	Max.	Unit	Test Condition
Drain-Source Breakdown Voltage	BV _{DSS}	600	–	–	V	V _{GS} =0V, I _D =250μA
Breakdown Voltage Temp. Coefficient	ΔBV _{DSS} /ΔT _j	–	0.6	–	V/°C	Reference to 25°C, I _D =1mA
Gate Threshold Voltage	V _{GS(th)}	2.0	–	4.0	V	V _{DS} =V _{GS} , I _D =250μA
Gate-Source Leakage Current	I _{GSS}	–	–	±100	nA	V _{GS} =±20V
Drain-Source Leakage Current (T _j =25°C)	I _{DSS}	–	–	100	μA	V _{DS} =600V, V _{GS} =0
Drain-Source Leakage Current(T _j =150°C)		–	–	500	μA	V _{DS} =480V, V _{GS} =0
Static Drain-Source On-Resistance	R _{DS(ON)}	–	7.2	8.0	Ω	V _{GS} =10V, I _D =0.8A
Forward Transconductance	G _{fs}	–	0.8	–	S	V _{DS} =50V, I _D =0.8A
Total Gate Charge ³	Q _g	–	7.7	–	nC	I _D =1.6A V _{DS} =480V V _{GS} = 10V
Gate-Source Charge	Q _{gs}	–	1.5	–		
Gate-Drain ("Miller") Charge	Q _{gd}	–	2.6	–		
Turn-on Delay Time ³	T _{d(ON)}	–	8	–	nS	V _{DD} =300V I _D =1.6A V _{GS} =10V R _G =10 Ω R _D =187.5 Ω
Rise Time	T _r	–	5	–		
Turn-off Delay Time	T _{d(OFF)}	–	14	–		
Fall Time	T _f	–	7	–		
Input Capacitance	C _{iss}	–	286	–	pF	V _{GS} =0V V _{DS} =25V f=1.0MHz
Output Capacitance	C _{oss}	–	25	–		
Reverse Transfer Capacitance	C _{rss}	–	5	–		

Source-Drain Diode

Parameter	Symbol	Min.	Typ.	Max.	Unit	Test Condition
Forward On Voltage ³	V _{SD}	–	–	1.5	V	I _S =1.6A, V _{GS} =0V, T _j =25°C
Continuous Source Current(Body Diode)	I _S	–	–	1.6	A	V _D =V _G =0V, V _S =1.5 V
Pulsed Source Current(Body Diode) ¹	I _{SM}	–	–	6	A	

Notes: 1. Pulse width limited by safe operating area.

2. Starting T_j=25°C, V_{DD}=50V, L=10mH, R_G=25Ω, I_{AS}=1.6A.

3. Pulse width ≤ 300μs, duty cycle ≤ 2%.

Characteristics Curve

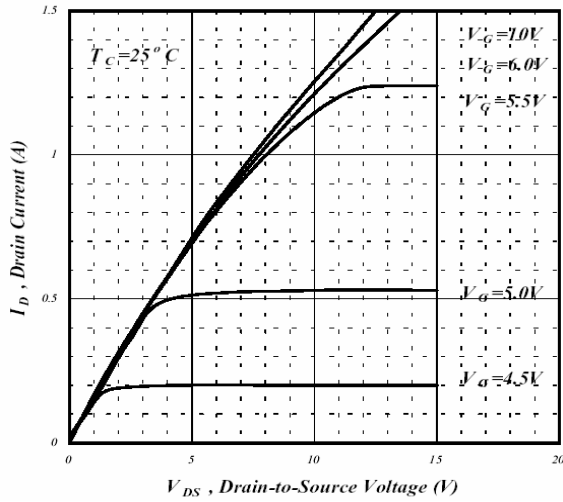

Fig 1. Typical Output Characteristics

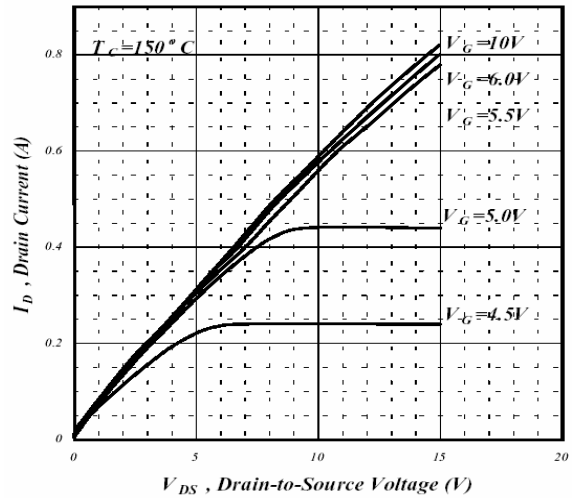

Fig 2. Typical Output Characteristics

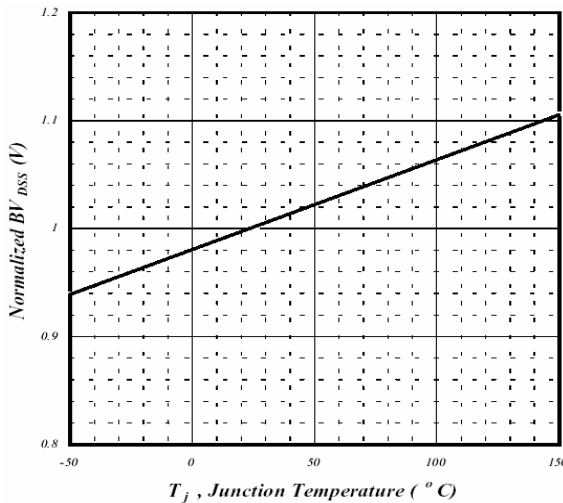

Fig 3. Normalized BV_{DSS} v.s. Junction Temperature

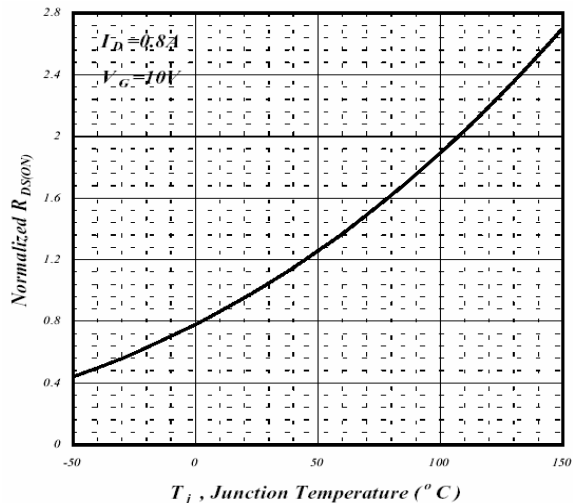

Fig 4. Normalized On-Resistance v.s. Junction Temperature

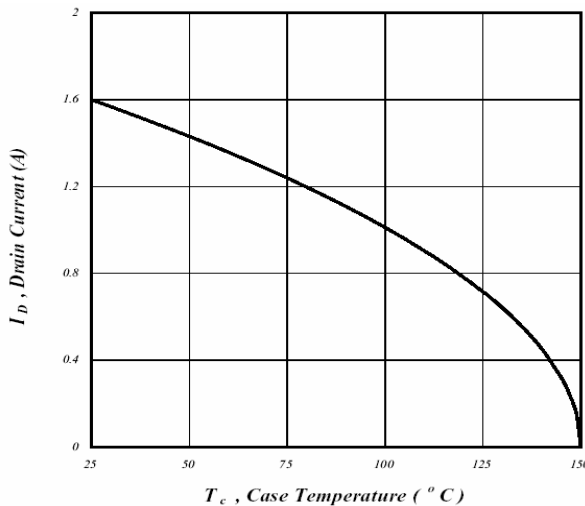

Fig 5. Maximum Drain Current v.s. Case Temperature

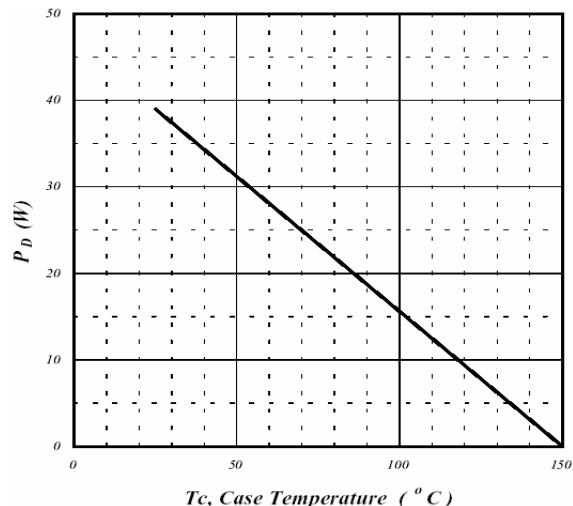

Fig 6. Type Power Dissipation

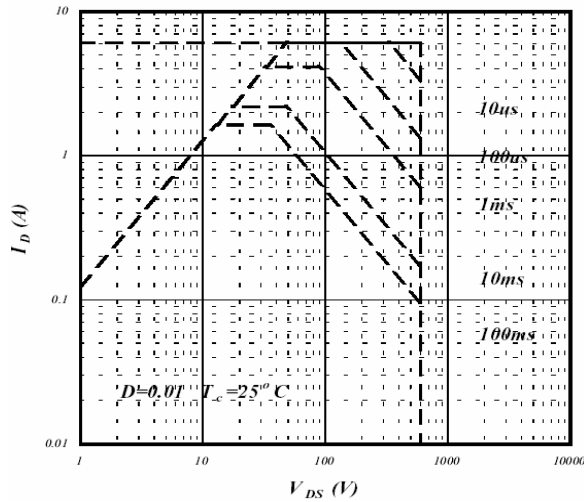

Fig 7. Maximum Safe Operating Area

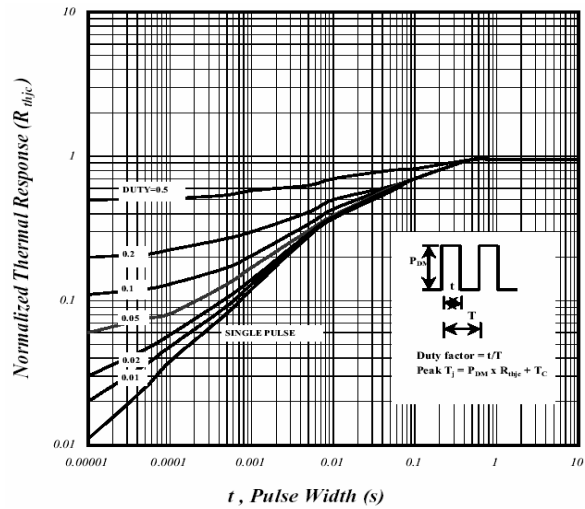

Fig 8. Effective Transient Thermal Impedance

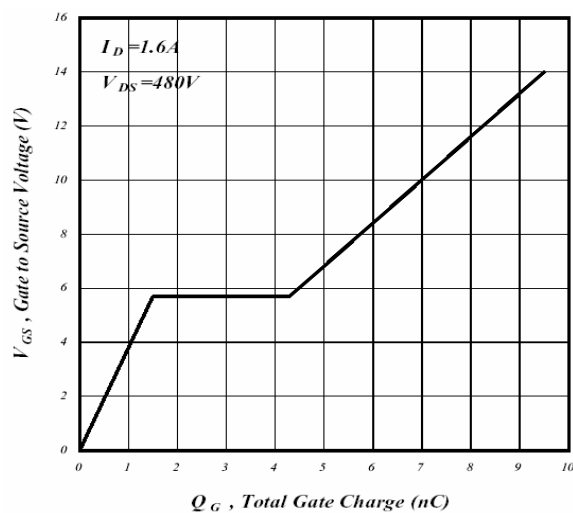

Fig 9. Gate Charge Characteristics

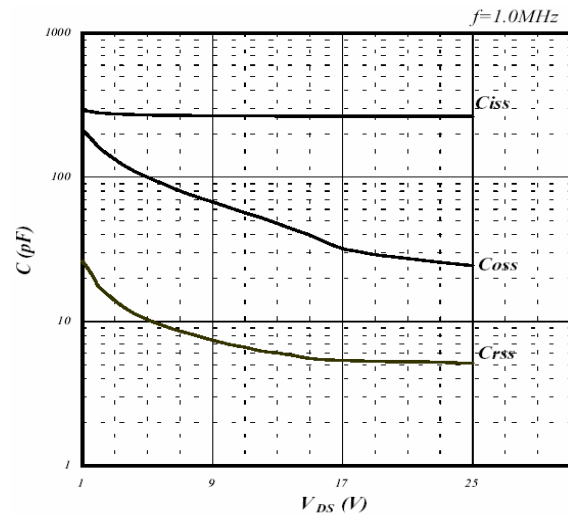

Fig 10. Typical Capacitance Characteristics

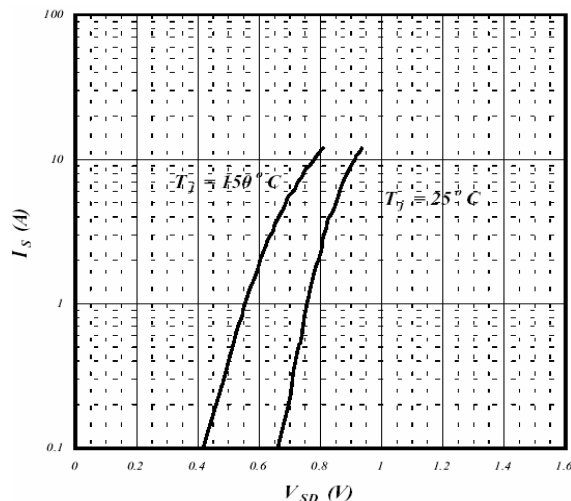

Fig 11. Forward Characteristics of Reverse Diode

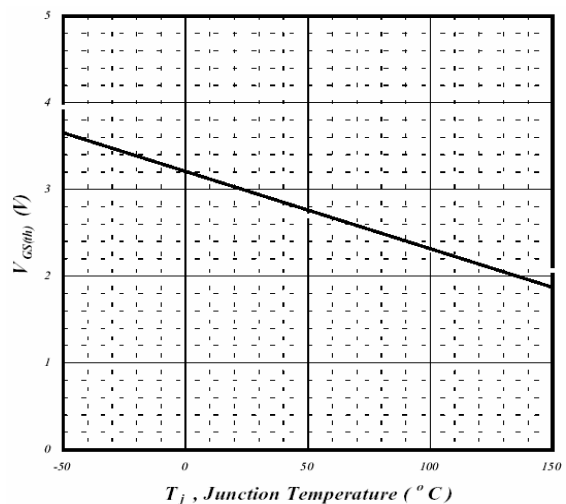

Fig 12. Gate Threshold Voltage v.s. Junction Temperature

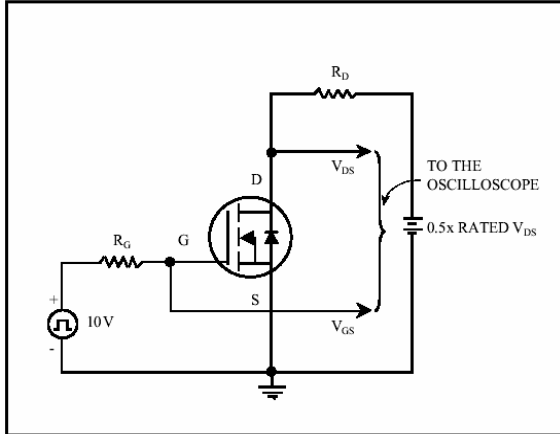

Fig 13. Switching Time Circuit

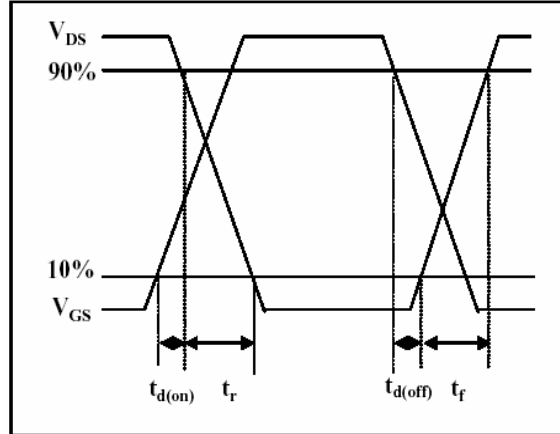

Fig 14. Switching Time Waveform

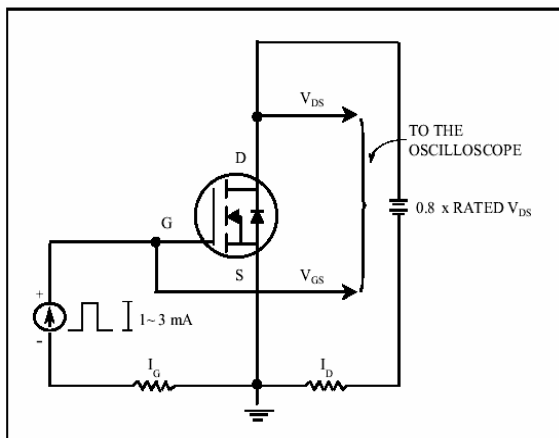

Fig 15. Gate Charge Circuit

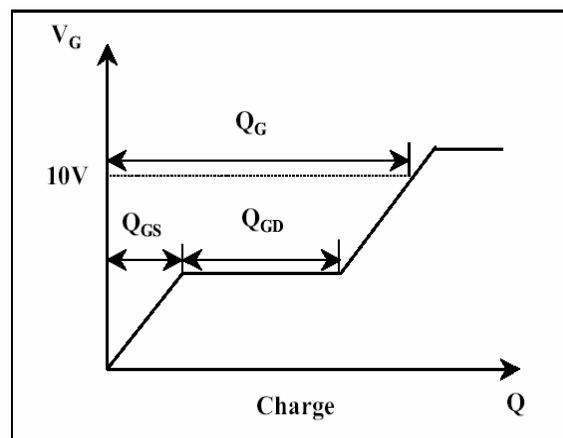

Fig 16. Gate Charge Waveform