



**JEWEL HILL ELECTRONIC CO.,LTD.**

**SPECIFICATIONS FOR  
LCD MODULE**

**Module No. GT2030**

Office Address: Rm. 518,5/F., 101 Shangbu Industrial District,  
HuaqiangNorthRoad, Shenzhen, China

TEL : (86)-755-83362489 83617492

FAX: (86)-755-83286396 83365871

E-mail: [sales@jewelhillelectronic.com](mailto:sales@jewelhillelectronic.com)  
[jhlcd@21cn.com](mailto:jhlcd@21cn.com)

Website: [www.jewelhillelectronic.com](http://www.jewelhillelectronic.com)

## **TABLE OF CONTENTS**

<b>LCM NUMBER SYSTEM .....</b>	<b>2</b>
<b>1. GENERAL DESCRIPTION .....</b>	<b>3</b>
<b>2. FEATURES.....</b>	<b>3</b>
<b>3. MECHANICAL SPECIFICATION .....</b>	<b>3</b>
<b>4. MECHANICAL DIMENSION .....</b>	<b>4</b>
<b>5. MAXIMUM RATINGS .....</b>	<b>5</b>
<b>6. ELECTRICAL CHARACTERISTICS .....</b>	<b>5</b>
<b>7. MODULE FUNCTION DESCRIPTION .....</b>	<b>6</b>
<b>8. ELECTRO-OPTICAL CHARACTERISTICS .....</b>	<b>18</b>
<b>9. RELIABILITY.....</b>	<b>21</b>
<b>10. PRECAUTIONS FOR USING LCD MODULES .....</b>	<b>22</b>
<b>11. USING LCD MODULES.....</b>	<b>24</b>
<b>12. REVISION HISTORY .....</b>	<b>26</b>
<b>SAMPLE APPROVED REPORT .....</b>	<b>27</b>

## LCM Number System

GT 2030 F W D S P F N O-V00-L Y C X

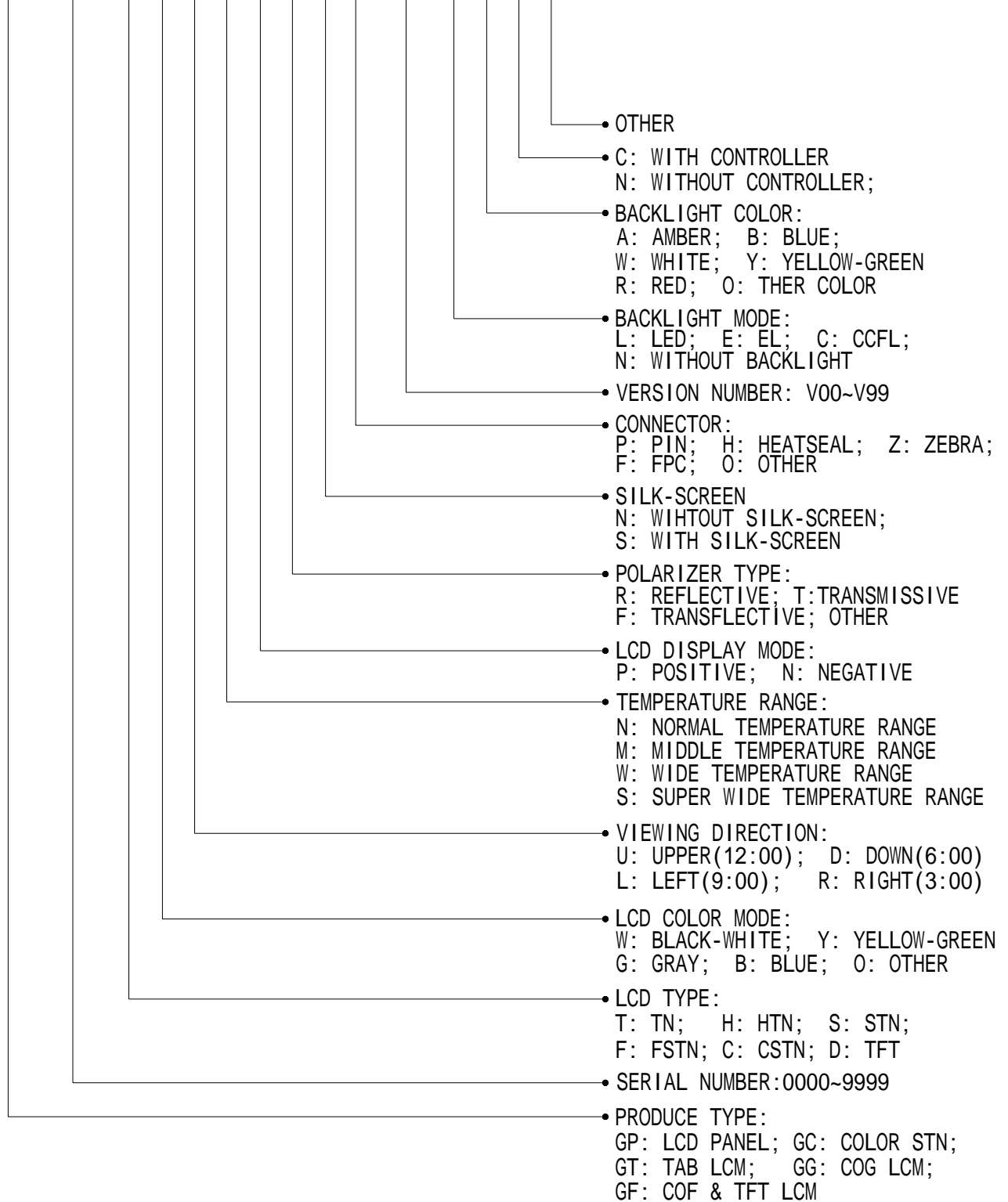

## 1. GENERAL DESCRIPTION

The GT2030 is a 128 x 64 Dots Graphic LCD module. It has a FSTN panel composed of 128 segments and 64 commons. The LCM can be easily accessed by microcontroller via parallel or series interface.

## 2. FEATURES

Display Mode	Transflective and positive
	FSTN module
Display Format	Graphic 128x64 dots
Input Data	8 bit parallel or series data input from MPU (Selection with PCB)
Multiplexing Ratio	1/65 Duty
Bias	1/9 Bias
Viewing Direction	6 O'clock
Backlight	LED(Yellow-Green)

## 3. MECHANICAL SPECIFICATION

Item	Specifications	Unit
Dimensional outline	60.2(LED) x (43.7+42.5) x 6.8(max)	mm
Resolution	128segs x 64coms	dots
Active area	47.33(W) x 26.21(H)	mm
Dots pitch	0.37(W)×0.41(H)	mm
Dots size	0.34(W)×0.38(H)	mm

## 4. MECHANICAL DIMENSION

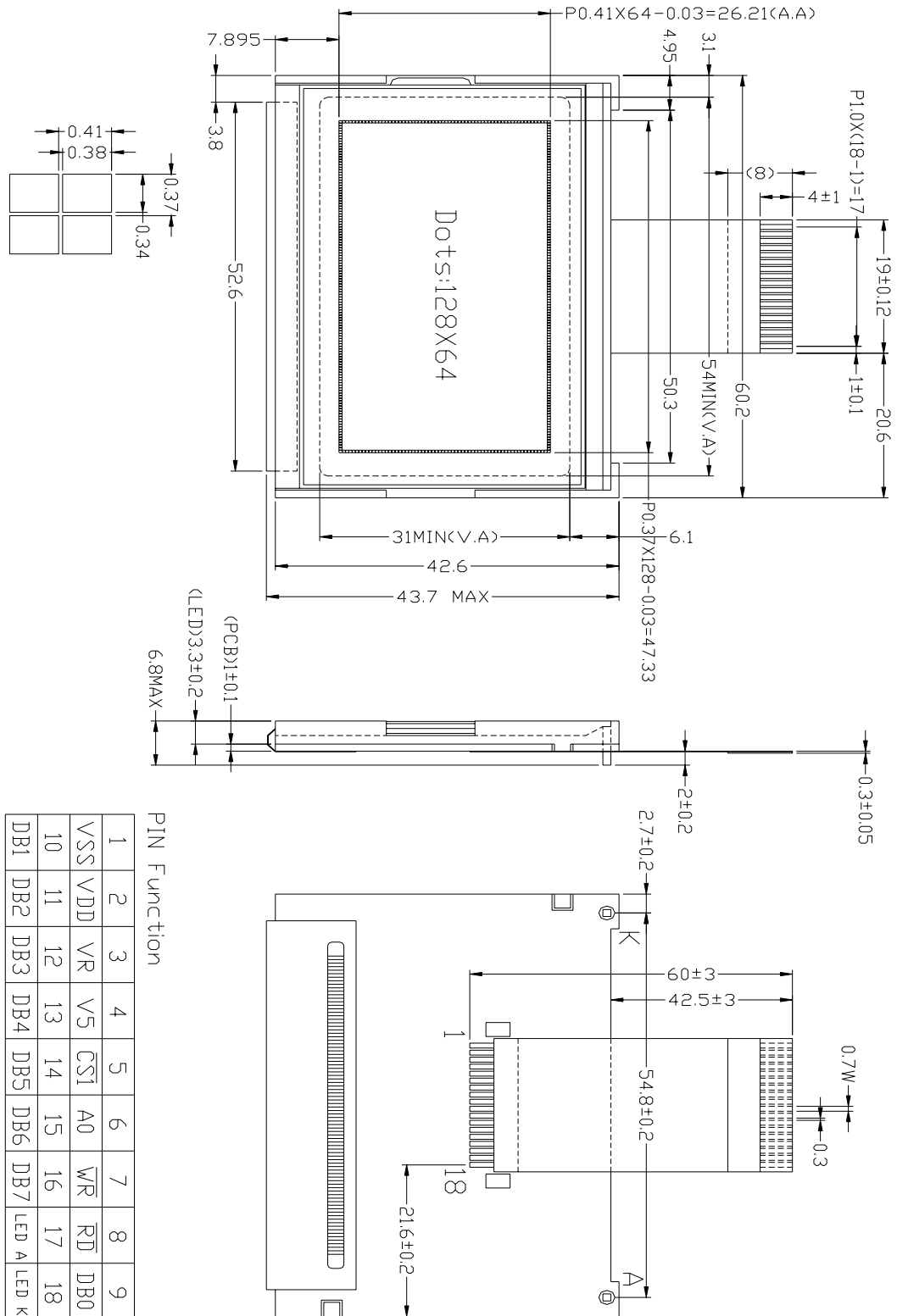

## 5. MAXIMUM RATINGS

Item	Symbol	Min	Max	Unit	Note
Supply voltage	$V_{DD} - V_{SS}$	-0.3	4.0	V	
	$V_{LCD}$	-0.3	18.0	V	
Input Voltage	$V_{IN}$	-0.3	$V_{DD}+0.3$	V	
Operating temperature	$T_{OPR}$	-20	+70	°C	
Storage temperature	$T_{STR}$	-30	+80	°C	
Humidity	---	---	90	%RH	

## 6. ELECTRICAL CHARACTERISTICS

Item		Symbol	Condition	Min.	Typ.	Max.	Unit
Supply Voltage	Logic	$V_{DD}$	---	---	3.3	---	V
Input Voltage	H level	$V_{IH}$	---	$0.8V_{DD}$	---	$V_{DD}$	V
	L level	$V_{IL}$		$V_{SS}$	---	$0.2V_{DD}$	
Current Consumption (LCD DRIVER)		$I_{DD}$	$V_{DD}=3.3V;$ $V_{LCD}=8.5V, T_{amb}=25^{\circ}C;$	---	---	1.2	mA
LCD Driving Voltage		$V_{LCD}$	Bias=1/9 $V_{LCD}=V_0-V_{SS}$	---	8.5	---	V

## 7. MODULE FUNCTION DESCRIPTION

### 7.1. PIN DESCRIPTION

Pin No.	Symbol	Description
1	VSS	Power Supply for Ground(0V)
2	VDD	Power Supply for Positive(3.3v)
3	VR	LCD Dirving Voltage External Regulation Terminal
4	V0	LCD Driving Voltage
5	/CS1	Chip Selection
6	A0	Data/Command Register Selection
7	/RW	Write Signal Input or Read/Write Selection Terminal
8	/RD	Read Signal Input or Read/Write Enable Signal Input
9	DB0	8-bit bi-directional Data bus. when "P/S=L", D0-D5 fixed to "H". D6 is serial clock input (SCL), D7 is serial data input (SDA).
10	DB1	
11	DB2	
12	DB3	
13	DB4	
14	DB5	
15	DB6	
16	DB7	
17	LEDA	Power Supply for LED Backlight
18	LEDK	

## 7.2 TIMING CHARACTERISTICS

### 1.SYSTEM BUS READ/WRITE CHARACTERISTIC

System Bus Read/Write Characteristics 1 (For the 8080 Series MPU)

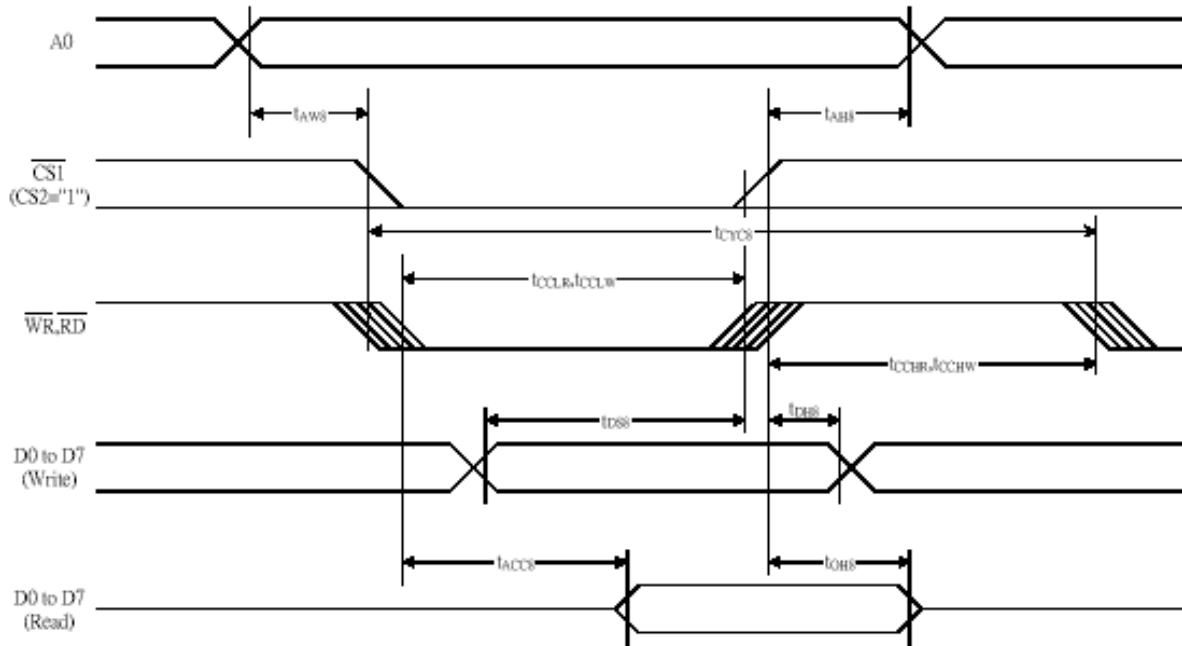

Figure 37

Table 24

(VDD = 3.3V, Ta = 25°C)

Item	Signal	Symbol	Condition	Rating		Units
				Min.	Max.	
Address hold time	A0	tAH8		0	—	Ns
Address setup time		tAW8		0	—	
System cycle time		tCYC8		240	—	
Enable L pulse width (WRITE)	WR	tCCLW		80	—	
Enable H pulse width (WRITE)		tCCHW		80	—	
Enable L pulse width (READ)	RD	tCCLR		140	—	
Enable H pulse width (READ)		tCCHR		80	—	
WRITE Data setup time	D0 to D7	tDS8		40	—	
WRITE Address hold time		tDH8		0	—	
READ access time		tACC8	CL = 100 pF	—	70	
READ Output disable time		tOH8	CL = 100 pF	5	50	





**Table 25**

(VDD = 2.7 V , Ta = 25°C )

Item	Signal	Symbol	Condition	Rating		Units
				Min.	Max.	
Address hold time	A0	tAH8		0	—	ns
Address setup time		tAW8		0	—	
System cycle time		tCYC8		400	—	
Enable L pulse width (WRITE)	WR	tCCLW		220	—	
Enable H pulse width (WRITE)		tCCHW		180	—	
Enable L pulse width (READ)	RD	tCCLR		220	—	
Enable H pulse width (READ)		tCCHR		180	—	
WRITE Data setup time	D0 to D7	tDS8		40	—	
WRITE Address hold time		tDH8		0	—	
READ access time		tACC8	CL = 100 pF	—	140	
READ Output disable time		tOH8	CL = 100 pF	10	100	

**Table 26**

(VDD = 1.8V , Ta = 25°C )

Item	Signal	Symbol	Condition	Rating		Units
				Min.	Max.	
Address hold time	A0	tAH8		0	—	ns
Address setup time		tAW8		0	—	
System cycle time		tCYC8		640	—	
Enable L pulse width (WRITE)	WR	tCCLW		360	—	
Enable H pulse width (WRITE)		tCCHW		280	—	
Enable L pulse width (READ)	RD	tCCLR		360	—	
Enable H pulse width (READ)		tCCHR		280	—	
WRITE Data setup time	D0 to D7	tDS8		80	—	
WRITE Address hold time		tDH8		0	—	
READ access time		tACC8	CL = 100 pF	—	240	
READ Output disable time		tOH8	CL = 100 pF	10	200	

\*1 The input signal rise time and fall time (tr, tf) is specified at 15 ns or less. When the system cycle time is extremely fast, (tr + tf) ≤ (tCYC8 – tCCLW – tCCHW) for (tr + tf) ≤ (tCYC8 – tCCLR – tCCHR) are specified.

\*2 All timing is specified using 20% and 80% of VDD as the reference.

\*3 tCCLW and tCCLR are specified as the overlap between /CS1 being "L" (CS2 = "H") and /WR and /RD being at the "L" level.

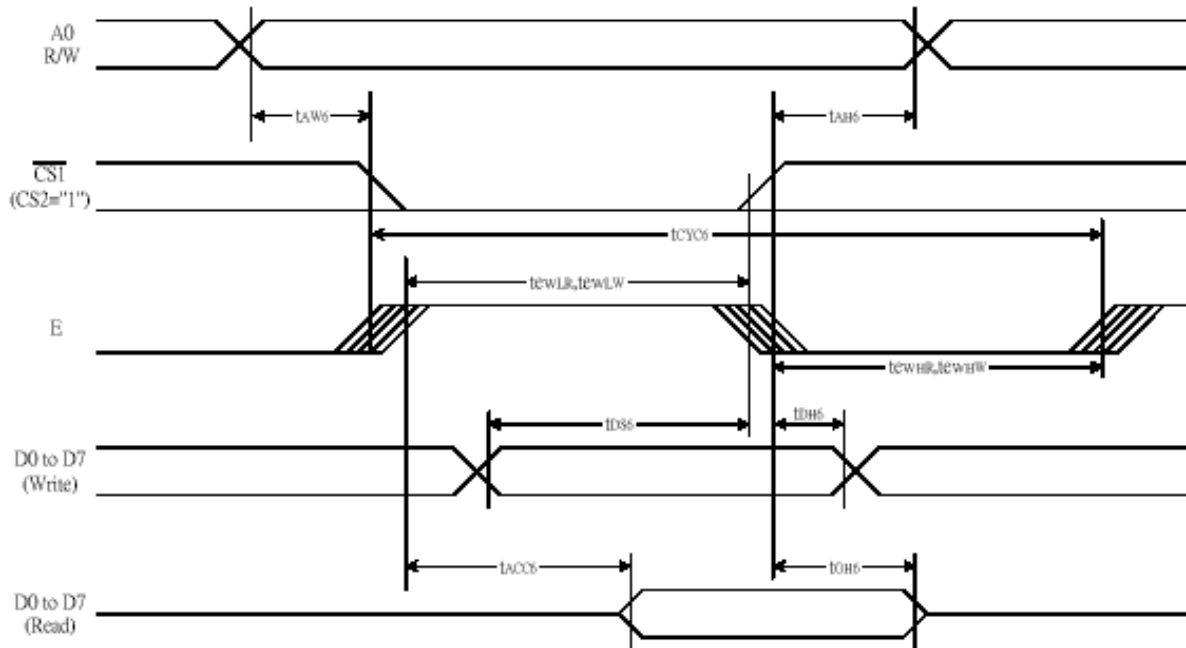

System Bus Read/Write Characteristics 2 (For the 6800 Series MPU)

Figure 38

Table 27

(VDD = 3.3 V , Ta = 25°C )

Item	Signal	Symbol	Condition	Rating		Units
				Min.	Max.	
Address hold time	A0	tAH6		0	—	ns
Address setup time		tAW6		0	—	
System cycle time		tCYC6		240	—	
Enable L pulse width (WRITE)	WR	tEHLW		80	—	
Enable H pulse width (WRITE)		tEWHW		80	—	
Enable L pulse width (READ)	RD	tEHLR		80	—	
Enable H pulse width (READ)		tEWHR		140	—	
WRITE Data setup time	D0 to D7	tDS6		40	—	
WRITE Address hold time		tDH6		0	—	
READ access time		tACC6	CL = 100 pF	—	70	
READ Output disable time		tOH6	CL = 100 pF	5	50	



**Table 28**

(VDD = 2.7V , Ta =25°C )

Item	Signal	Symbol	Condition	Rating		Units
				Min.	Max.	
Address hold time	A0	tAH6		0	—	ns
Address setup time		tAW6		0	—	
System cycle time		tCYC6		400	—	
Enable L pulse width (WRITE)	WR	tEWLW		220	—	
Enable H pulse width (WRITE)		tEWHW		180	—	
Enable L pulse width (READ)	RD	tEWLR		220	—	
Enable H pulse width (READ)		tEWHR		180	—	
WRITE Data setup time	D0 to D7	tDS6		40	—	
WRITE Address hold time		tDH6		0	—	
READ access time		tACC6	CL = 100 pF	—	140	
READ Output disable time		tOH6	CL = 100 pF	10	100	

**Table 29**

(VDD =1.8V , Ta =25°C )

Item	Signal	Symbol	Condition	Rating		Units
				Min.	Max.	
Address hold time	A0	tAH6		0	—	ns
Address setup time		tAW6		0	—	
System cycle time		tCYC6		640	—	
Enable L pulse width (WRITE)	WR	tEWLW		360	—	
Enable H pulse width (WRITE)		tEWHW		280	—	
Enable L pulse width (READ)	RD	tEWLR		360	—	
Enable H pulse width (READ)		tEWHR		280	—	
WRITE Data setup time	D0 to D7	tDS6		80	—	
WRITE Address hold time		tDH6		0	—	
READ access time		tACC6	CL = 100 pF	—	240	
READ Output disable time		tOH6	CL = 100 pF	10	200	

\*1 The input signal rise time and fall time (tr, tf) is specified at 15 ns or less. When the system cycle time is extremely fast, (tr + tf) ≤ (tCYC6 – tEWLW – tEWHW) for (tr + tf) ≤ (tCYC6 – tEWLR – tEWHR) are specified.

\*2 All timing is specified using 20% and 80% of VDD as the reference.

\*3 tEWLW and tEWLR are specified as the overlap between CS1 being "L" (CS2 = "H") and E.

**The Serial Interface**

Figure 39

**Table 30**

(VDD = 3.3V, Ta = 25°C)

Item	Signal	Symbol	Condition	Rating		Units
				Min.	Max.	
Serial Clock Period	SCL	$T_{scyc}$		100	—	ns
SCL "H" pulse width		$T_{shw}$		50	—	
SCL "L" pulse width		$T_{slw}$		50	—	
Address setup time	A0	$T_{sas}$		20	—	
Address hold time		$T_{shw}$		10	—	
Data setup time	SI	$T_{ds}$		20	—	
Data hold time		$T_{sdh}$		10	—	
CS-SCL time	CS	$T_{css}$		20	—	
CS-SCL time		$T_{csh}$		40	—	

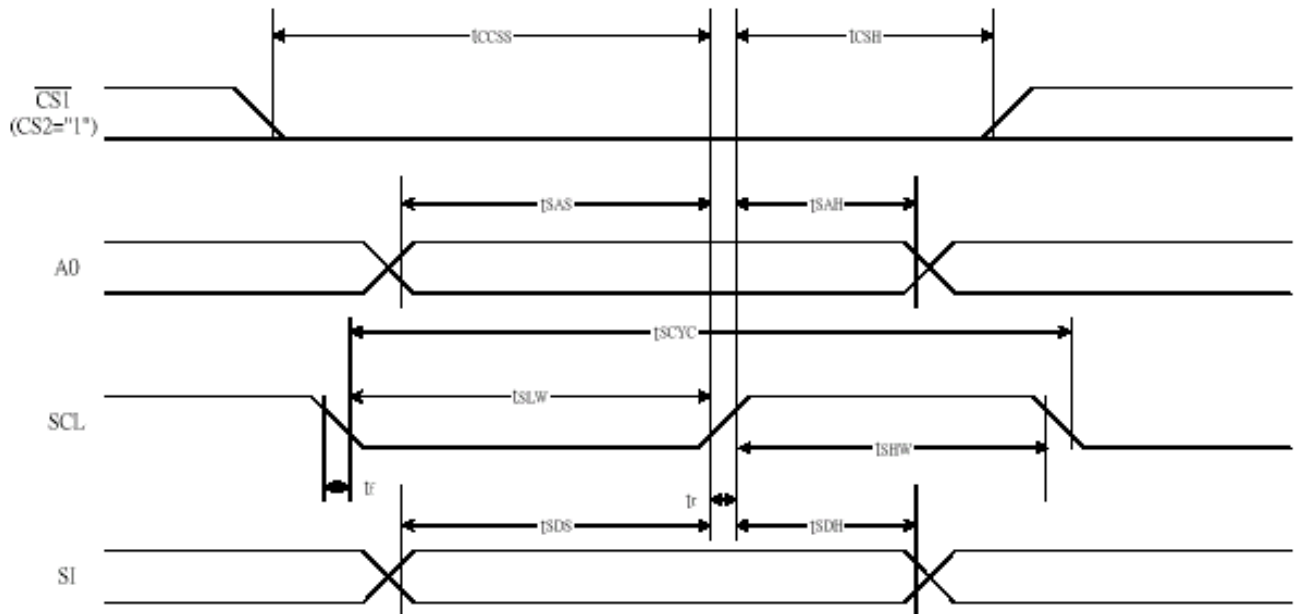
**Table 31**

(VDD = 2.7V, Ta = 25°C)

Item	Signal	Symbol	Condition	Rating		Units
				Min.	Max.	
Serial Clock Period	SCL	$T_{scyc}$		120	—	ns
SCL "H" pulse width		$T_{shw}$		60	—	
SCL "L" pulse width		$T_{slw}$		60	—	
Address setup time	A0	$T_{sas}$		30	—	
Address hold time		$T_{shw}$		20	—	
Data setup time	SI	$T_{ds}$		30	—	
Data hold time		$T_{sdh}$		20	—	
CS-SCL time	CS	$T_{css}$		30	—	
CS-SCL time		$T_{csh}$		60	—	

**Table 32**

(VDD = 1.8V , Ta = 25°C )

Item	Signal	Symbol	Condition	Rating		Units
				Min.	Max.	
Serial Clock Period	SCL	T <sub>SCYC</sub>		200	—	ns
SCL "H" pulse width		T <sub>SHW</sub>		80	—	
SCL "L" pulse width		T <sub>SLW</sub>		80	—	
Address setup time	A0	T <sub>SAS</sub>		60	—	
Address hold time		T <sub>SAH</sub>		40	—	
Data setup time	SI	T <sub>SDS</sub>		60	—	
Data hold time		T <sub>SDH</sub>		30	—	
CS-SCL time	CS	T <sub>CSS</sub>		40	—	
CS-SCL time		T <sub>CSH</sub>		100	—	

\*1 The input signal rise and fall time (tr, tf) are specified at 15 ns or less.

\*2 All timing is specified using 20% and 80% of VDD as the standard.

## 2. RESET TIMING

### Reset Timing

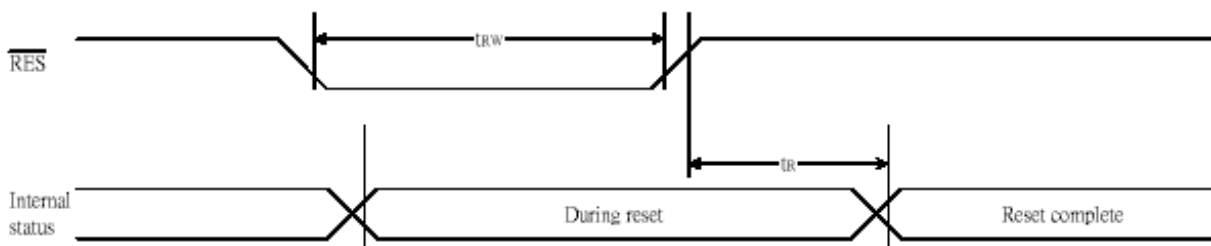

Figure 41

**Table 36**

(VDD = 3.3V , Ta = -40 to 85°C )

Item	Signal	Symbol	Condition	Rating			Units
				Min.	Typ.	Max.	
Reset time		tr		—	—	1.0	us
Reset "L" pulse width	/RES	trw		1.0	—	—	us

**Table 37**

(VDD = 2.7V , Ta = -40 to 85°C )

Item	Signal	Symbol	Condition	Rating			Units
				Min.	Typ.	Max.	
Reset time		tr		—	—	2.0	us
Reset "L" pulse width	/RES	trw		2.0	—	—	us

**Table 38**

(VDD = 1.8V , Ta = -40 to 85°C )

Item	Signal	Symbol	Condition	Rating			Units
				Min.	Typ.	Max.	
Reset time		tr		—	—	3.0	us
Reset "L" pulse width	/RES	trw		3.0	—	—	us

\*1 All timing is specified with 20% and 80% of VDD as the standard.

### 7.3 APPLICATION OF LCM

#### ■Reference circuit

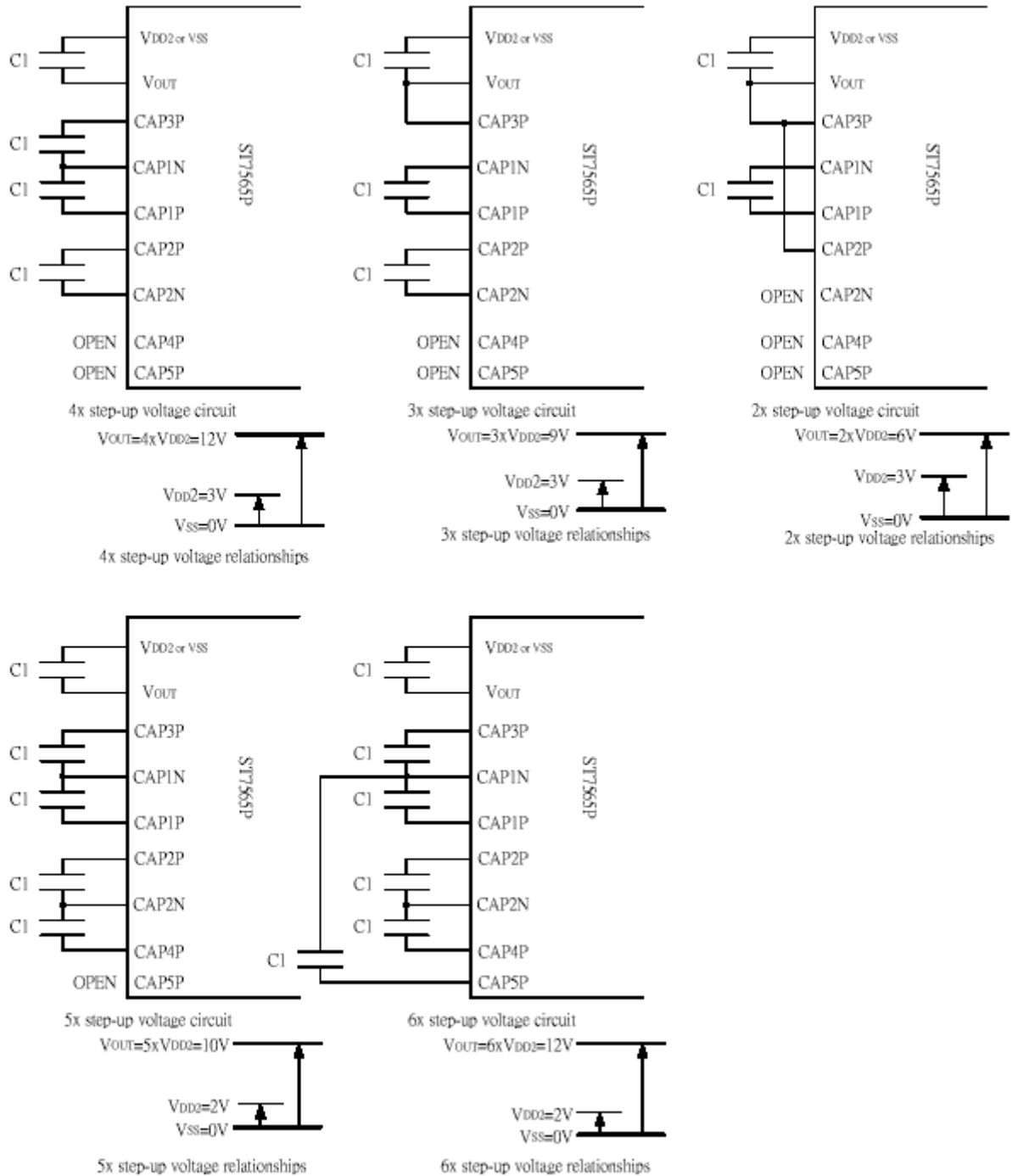

Figure 7

**Reference Circuit Examples**

1. When used all of the step-up circuit, voltage regulating circuit and V/F circuit

(1) When the voltage regulator internal resistor is used.

(Example where  $VDD2 = VDD$ , with 4x step-up)

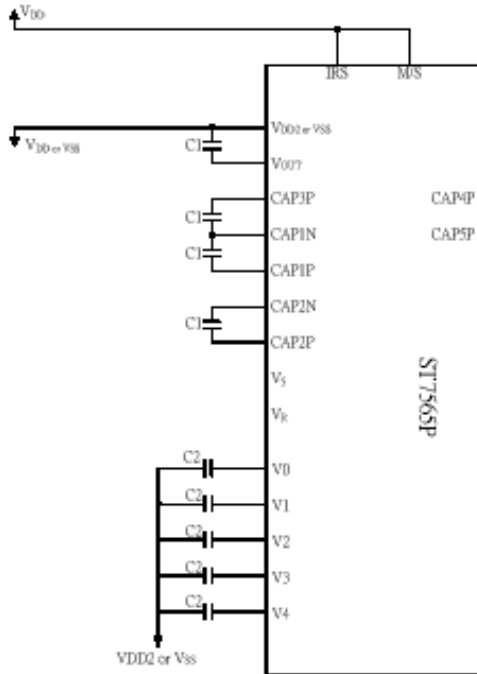

(2) When the voltage regulator internal resistor is not used.

(Example where  $VDD2 = VDD$ , with 4x step-up)

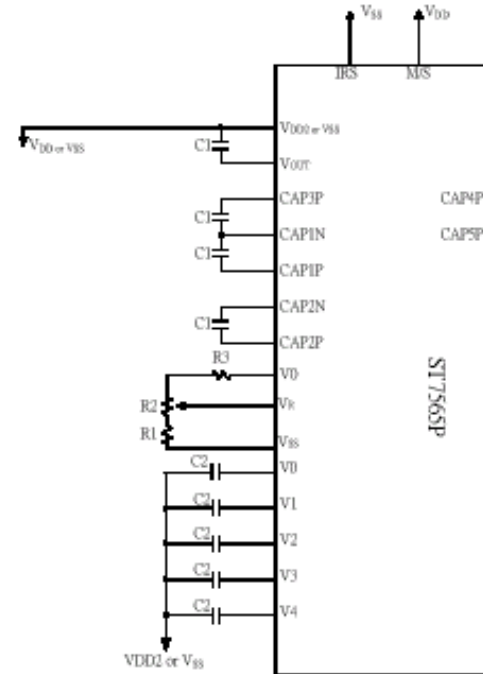

2. When the voltage regulator circuit and V/F circuit alone are used

(1) When the Vs voltage regulator internal resistor is not used.

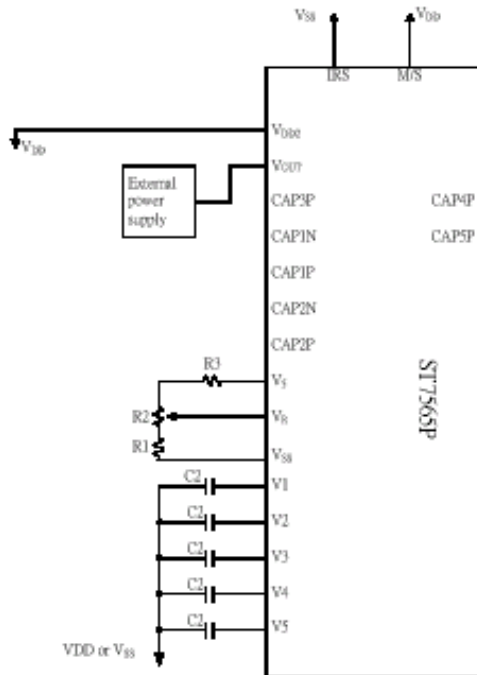

(2) When the Vs voltage regulator internal resistor is used.

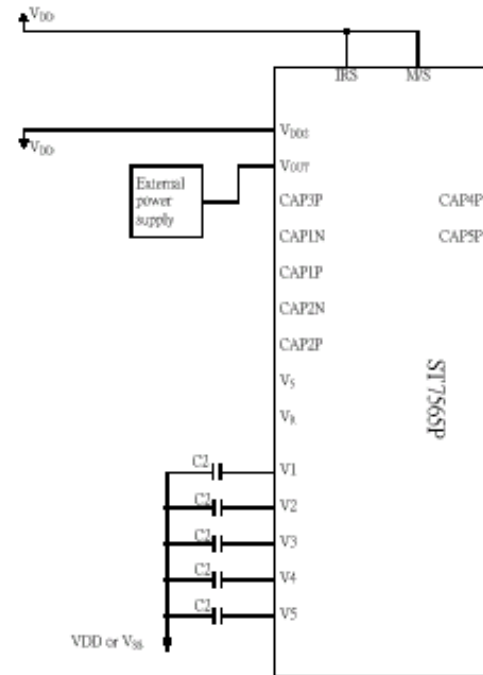

(3) When the V/F circuit alone is used

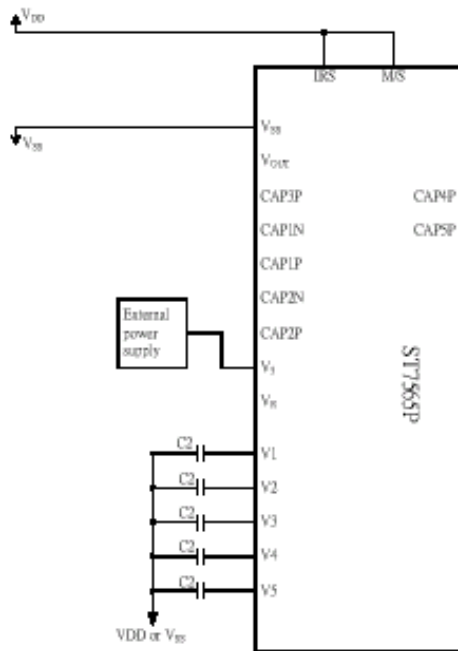

(4) When the built-in power is not used

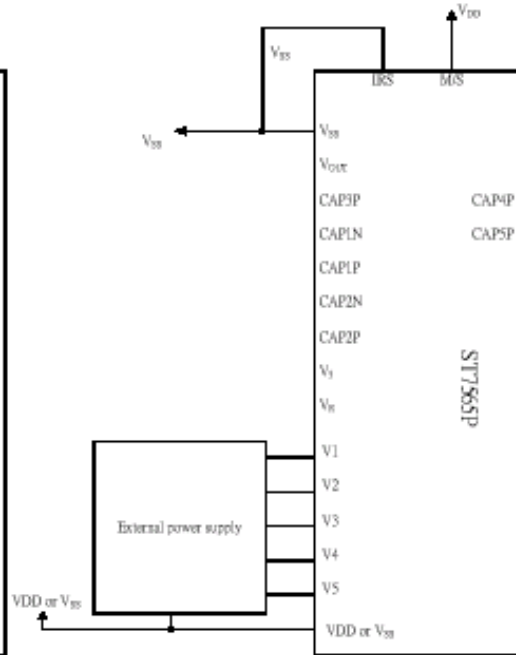

Item	Set value	units
c1	1.0 to 4.7	uF
c2	0.1 to 4.7	uF

C1 and C2 are determined by the size of the LCD being driven

- \* 1. Because the VR terminal input impedance is high, use short leads and shielded lines.
- \* 2. C1 and C2 are determined by the size of the LCD being driven. Select a value that will stabilize the liquid crystal drive voltage.

Example of the Process by which to Determine the Settings:

- Turn the voltage regulator circuit and voltage follower circuit ON and supply a voltage to VOUT from the outside.
- Determine C2 by displaying an LCD pattern with a heavy load (such as horizontal stripes) and selecting a C2 that stabilizes the liquid crystal drive voltages (V1 to V5). Note that all C2 capacitors must have the same capacitance value.
- Next turn all the power supplies ON and determine C1.

## 7.4 TABLE OF COMMAND





**Table 16: Table of ST7565P Commands**

(Note) \*: disabled data

Command	Command Code										Function		
	A0	/RD	/WR	D7	D6	D5	D4	D3	D2	D1		$\mu\mu$	
(1) Display ON/OFF	0	1	0	1	0	1	0	1	1	1	0	LCD display ON/OFF 0: OFF, 1: ON	
(2) Display start line set	0	1	0	0	1	Display start address					1	Sets the display RAM display start line address	
(3) Page address set	0	1	0	1	0	1	1	Page address				1	Sets the display RAM page address
(4) Column address set upper bit	0	1	0	0	0	0	1	Most significant column address				1	Sets the most significant 4 bits of the display RAM column address.
Column address set lower bit	0	1	0	0	0	0	0	Least significant column address				1	Sets the least significant 4 bits of the display RAM column address.
(5) Status read	0	0	1	Status				0	0	0	0	1	Reads the status data
(6) Display data write	1	1	0	Write data							0	1	Writes to the display RAM
(7) Display data read	1	0	1	Read data							0	1	Reads from the display RAM
(8) ADC select	0	1	0	1	0	1	0	0	0	0	0	1	Sets the display RAM address SEG output correspondence 0: normal, 1: reverse
(9) Display normal/reverse	0	1	0	1	0	1	0	0	1	1	0	1	Sets the LCD display normal/reverse 0: normal, 1: reverse
(10) Display all points ON/OFF	0	1	0	1	0	1	0	0	1	0	0	1	Display all points 0: normal display 1: all points ON
(11) LCD bias set	0	1	0	1	0	1	0	0	0	1	0	1	Sets the LCD drive voltage bias ratio 0: 1/9 bias, 1: 1/7 bias (ST7565P)
(12) Read/modify/write	0	1	0	1	1	1	0	0	0	0	0	0	Column address increment At write: +1 At read: 0
(13) End	0	1	0	1	1	1	0	1	1	1	0	0	Clear read/modify/write
(14) Reset	0	1	0	1	1	1	0	0	0	0	1	0	Internal reset
(15) Common output mode select	0	1	0	1	1	0	0	0	0	*	*	*	Select COM output scan direction 0: normal direction 1: reverse direction
(16) Power control set	0	1	0	0	0	1	0	1	Operating mode			0	Select internal power supply operating mode
(17) V <sub>0</sub> voltage regulator internal resistor ratio set	0	1	0	0	0	1	0	0	Resistor ratio			0	Select internal resistor ratio(R <sub>b</sub> /R <sub>a</sub> ) mode
(18) Electronic volume mode set Electronic volume register set	0	1	0	1	0	0	0	0	0	0	0	1	Set the V <sub>0</sub> output voltage electronic volume register
(19) Static indicator ON/OFF Static indicator register set	0	1	0	1	0	1	0	1	1	0	0	1	0: OFF, 1: ON Set the flashing mode
(20) Booster ratio set	0	1	0	1	1	1	1	1	1	0	0	0	select booster ratio 00: 2x,3x,4x 01: 5x 11: 6x
(21) Power saver													Display OFF and display all points ON compound command
(22) NOP	0	1	0	1	1	1	0	0	0	0	1	1	Command for non-operation
(23) Test	0	1	0	1	1	1	1	*	*	*	*	*	Command for IC test. Do not use this command

## 8. ELECTRO-OPTICAL CHARACTERISTICS

Item	Symbol	Condition	Temp	Min	Typ.	Max	Units	Note
LCD driving voltage	V <sub>LCD</sub>	$\theta = \phi = 0$	0°C	8.4	8.7	9.0	V	NOTE1
			25°C	8.2	8.5	8.8		
			50°C	8.0	8.3	8.6		
Response Time	Rise Time (Tr)	$\theta = \phi = 0$	0°C	---	---	--	msec	NOTE2
	Decay Time (Tf)			---	---	---		
	Rise Time (Tr)		25°C	---	225	340		
	Decay Time (Tf)			---	240	360		
	Rise Time (Tr)		50°C	---	---	--		
	Decay Time (Tf)			---	---	--		
Contrast Ratio	Cr	$\theta = \phi = 0$	25°C	5	10	---	---	NOTE4

Viewing Angle Range	$\theta (\phi = 0^\circ)$ (6'')	$\phi = 90^\circ$ (3'')	$\phi = 180^\circ$ (12'')	$\phi = 270^\circ$ (9'')	備註
$\theta (25^\circ\text{C})$ CR≥2	45	35	25	30	Deg NOTE3

● For panel only

• **Electro-Optical Characteristics Measuring Equipment(DMS501)**

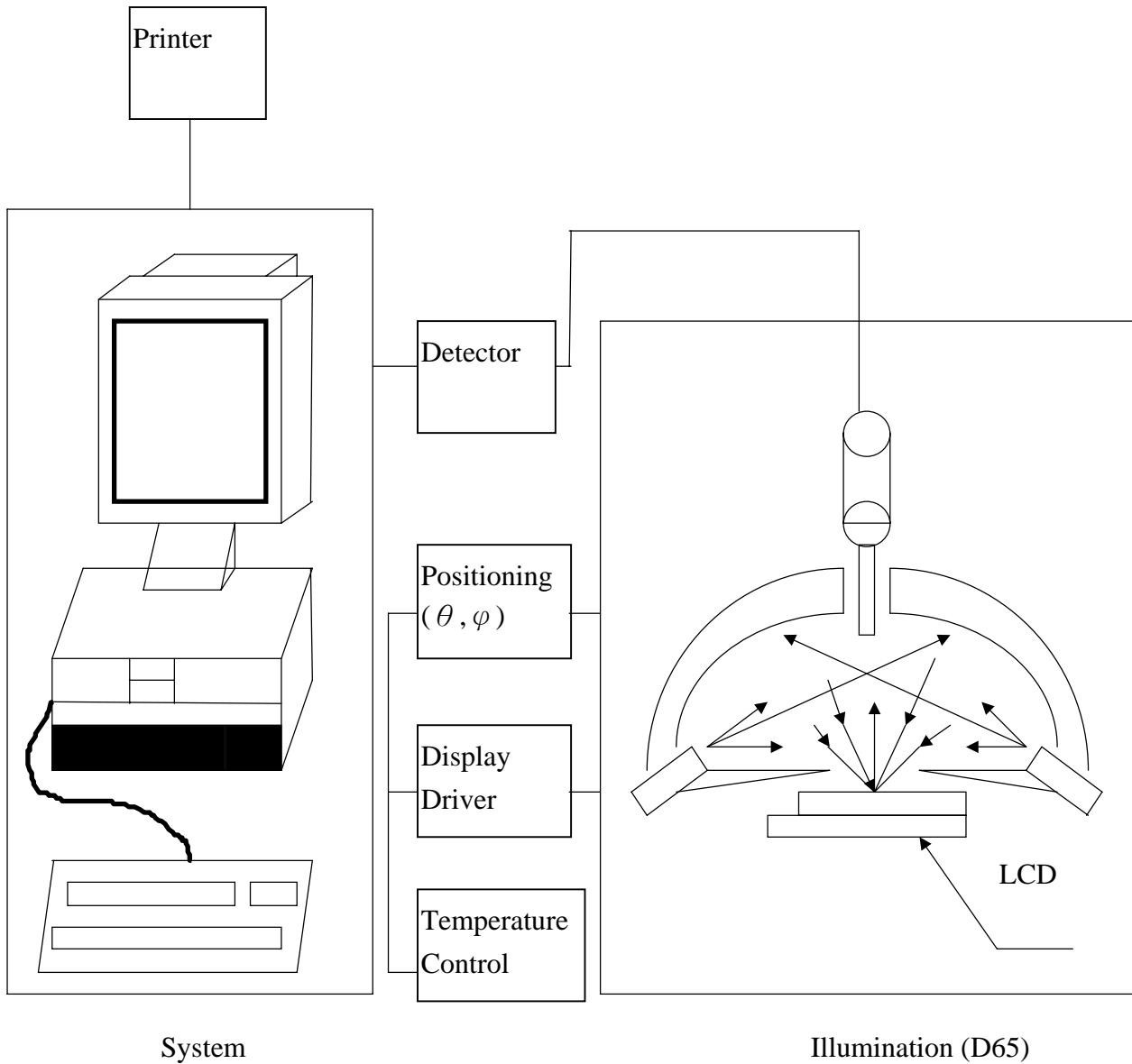

• **Note 1. Definition of Driving Voltage(  $V_{lcd}$  ) :**

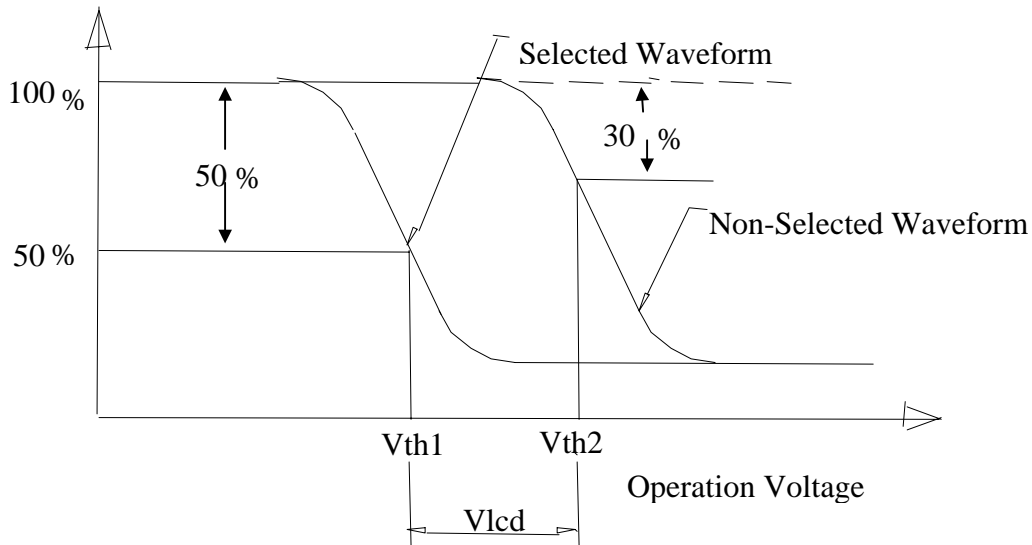

**• Note 2. Definition of Optical Response Time :**

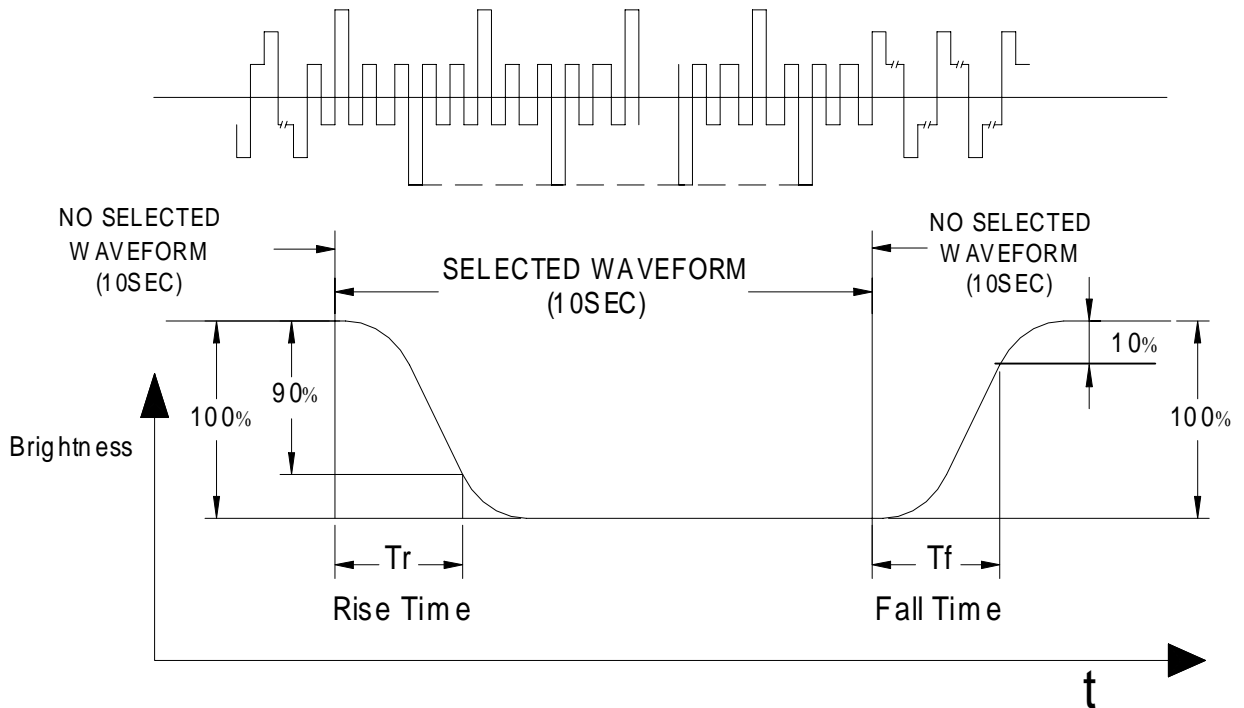

**• Note 3. Definition of Viewing Angle  $\theta$  and  $\phi$  :**

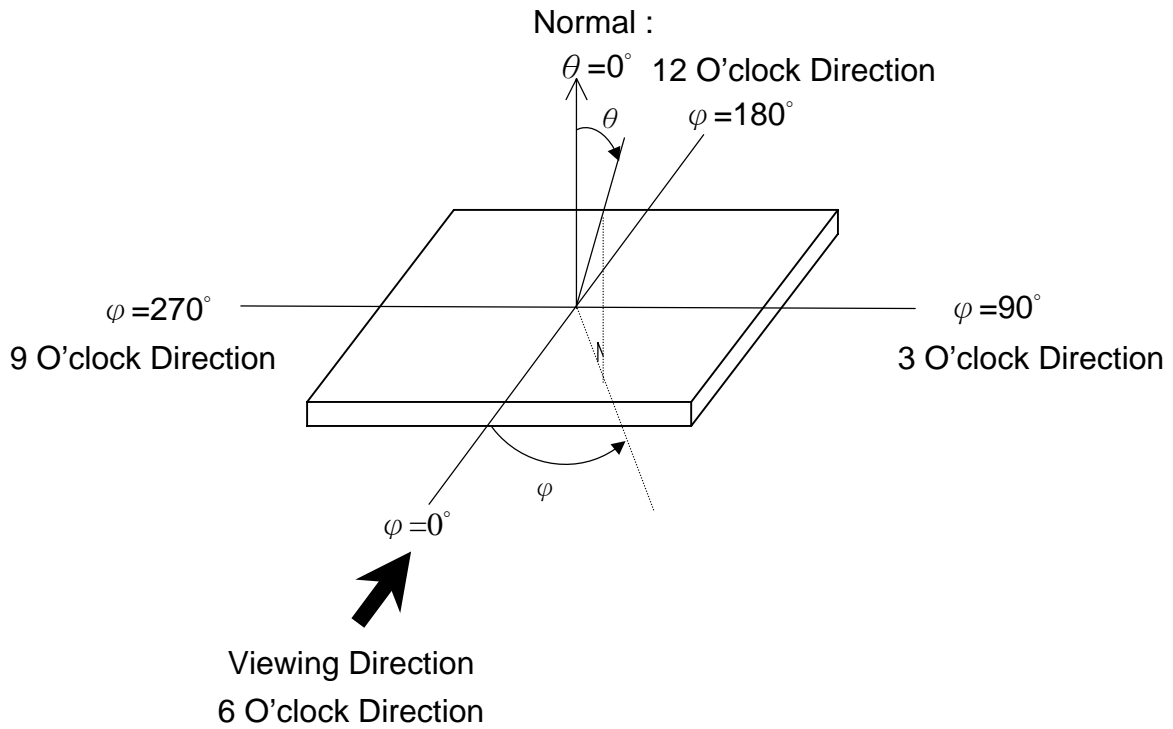

• **Note 4. Definition of Contrast ratio( CR) :**

$$CR = \frac{\text{Brightness of Non-selected Segment (B2)}}{\text{Brightness of Selected Segment (B1)}}$$

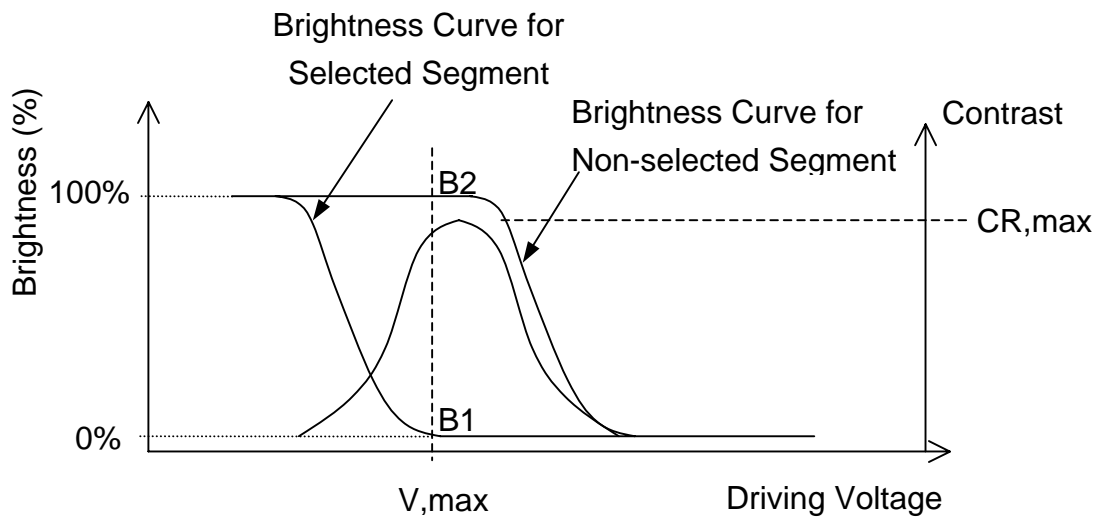

## 9. RELIABILITY

### 9.1. MTBF

The LCD module shall be designed to meet a minimum MTBF value of 50000 hours with normal. (25°C in the room without sunlight)

### 9.2. TESTS

NO.	ITEM	CONDITION	CRITERION
1	High Temperature Operating	70°C 120Hrs	<ul style="list-style-type: none"> <li>◦ No Defect Of Operational Function In Room Temperature Are Allowable.</li> <li>◦ IDD of LCM in Pre-and post-test should follow specification</li> </ul>
2	Low Temperature Operating	-20°C 120Hrs	
3	High Temperature/ Humidity Non-Operating	70°C ,90%RH ,120 Hrs	
4	High Temperature Non-Operating	80°C 120Hrs	
5	Low Temperature Non-Operating	-30°C 120Hrs	
6	Temperature Cycling Non-Operating	-20°C (30Min )↔ 70°C (30Min) 10 CYCLES	

Notes: Judgments should be made after exposure in room temperature for two hours.

## **10. PRECAUTIONS FOR USING LCD MODULES**

### **10.1. HANDLING PRECAUTIONS**

- (1) The display panel is made of glass. Do not subject it to a mechanical shock or impact by dropping it.
- (2) If the display panel is damaged and the liquid crystal substance leaks out, be sure not to get any in your mouth. If the substance contacts your skin or clothes, wash it off using soap and water.
- (3) Do not apply excessive force to the display surface or the adjoining areas since this may cause the color tone to vary.
- (4) The polarizer covering the display surface of the LCD module is soft and easily scratched. Handle this polarizer carefully.
- (5) If the display surface becomes contaminated, breathe on the surface and gently wipe it with a soft dry cloth. If it is heavily contaminated, moisten a cloth with one of the following solvents:
  - Isopropyl alcohol
  - Ethyl alcohol
- (6) Solvents other than those above mentioned may damage the polarizer.  
Especially, do not use the following:
  - Water
  - Ketone
  - Aromatic solvents
- (7) Extra care to minimize corrosion of the electrode. Water droplets, moisture condensation or a current flow in a high-humidity environment accelerates corrosion of the electrode.
- (8) Install the LCD Module by using the mounting holes. When mounting the LCD Module, make sure it is free of twisting, warping and distortion. In particular, do not forcibly pull or bend the I/O cable or the backlight cable.
- (9) Do not attempt to disassemble or process the LCD Module.
- (10) NC terminal should be open. Do not connect anything.
- (11) If the logic circuit power is off, do not apply the input signals.
- (12) To prevent destruction of the elements by static electricity, be careful to maintain an optimum work environment.
  - Be sure to ground the body when handling the LCD Module.
  - Tools required for assembling, such as soldering irons, must be properly grounded.
  - To reduce the amount of static electricity generated, do not conduct assembling and other work under dry conditions.

-The LCD Module is coated with a film to protect the display surface. Exercise care when peeling off this protective film since static electricity may be generated.

## 10.2. STORAGE CONDITIONS

When storing, avoid the LCD module to be exposed to direct sunlight of fluorescent lamps. For stability, to keep it away from high temperature and high humidity environment (The best condition is :  $23\pm 5^{\circ}\text{C}$ ,  $45\pm 20\%\text{RH}$ ). ESD protection is necessary for long-term storage also.

## 10.3. OTHERS

Liquid crystals solidify under low temperature (below the storage temperature range) leading to defective orientation or the generation of air bubbles (black or white). Air bubbles may also be generated if the module is subject to a low temperature.

If the LCD Module have been operating for a long time showing the same display patterns the display patterns may remain on the screen as ghost images and a slight contrast irregularity may also appear. A normal operating status can be recovered by suspending use for some time. It should be noted that this phenomenon does not adversely affect performance reliability.

To minimize the performance degradation of the LCD Module resulting from destruction caused by static electricity etc. exercise care to avoid holding the following sections when handling the modules.

- Exposed area of the printed circuit board.
- Terminal electrode sections.



## **11. Using LCD modules**

### **12.1 LIQUID CRYSTAL DISPLAY MODULES**

LCD is composed of glass and polarizer. Pay attention to the following items when handling.

- (1) Please keep the temperature within specified range for use and storage. Polarization degradation, bubble generation or polarizer peel-off may occur with high temperature and high humidity.
- (2) Do not touch, push or rub the exposed polarizers with anything harder than a HB pencil lead (glass, tweezers, etc).
- (3) N-hexane is recommended for cleaning the adhesives used to attach front/rear polarizers and reflectors made of organic substances, which will be damaged by chemicals such as acetone, toluene, ethanol and isopropyl alcohol.
- (4) When the display surface becomes dusty, wipe gently with absorbent cotton or other soft material like chamois soaked in petroleum ether. Do not scrub hard to avoid damaging the display surface.
- (5) Wipe off saliva or water drops immediately, contact with water over a long period of time may cause deformation or color fading.
- (6) Avoid contacting oil and fats.
- (7) Condensation on the surface and contact with terminals due to cold will damage, stain or polarizers. After products are tested at low temperature they must be warmed up in a container before coming in contact with room temperature air.
- (8) Do not put or attach anything on the display area to avoid leaving marks on.
- (9) Do not touch the display with bare hands. This will stain the display area and degrade insulation between terminals (some cosmetics are determinate to the polarizers).
- (10) As glass is fragile, it tends to become chipped during handling especially on the edges. Please avoid dropping or jarring.

### **12.2 INSTALLING LCD MODULE**

Attend to the following items when installing the LCM.

- (1) Cover the surface with a transparent protective plate to protect the polarizer and LC cell.
- (2) When assembling the LCM into other equipment, the spacer to the bit between the LCM and the fitting plate should have enough height to avoid causing stress to the module surface, refer to the individual specifications for measurements. The measurement tolerance should be  $\pm 0.1$ mm.

### **12.3 ELECTRO-STATIC DISCHARGE CONTROL**

Since this module uses a CMOS LSI, the same careful attention should be paid for electrostatic discharge as for an ordinary CMOS IC.

- (1) Make certain that you are grounded when handling LCM.
- (2) Before removing LCM from its packing case or incorporating it into a set, be sure the module and your body have the same electric potential.
- (3) When soldering the terminal of LCM, make certain the AC power source for the soldering iron does not leak.
- (4) When using an electric screwdriver to attach LCM, the screwdriver should be of ground potentiality to minimize as much as possible any transmission of electromagnetic waves produced sparks coming from the commutator of the motor.
- (5) As far as possible, make the electric potential of your work clothes and that of the workbenches to the ground potential.
- (6) To reduce the generation of electro-static discharge, be careful that the air in the work is not too dried. A relative humidity of 50%-60% is recommended.

## 12.4 PRECAUTIONS FOR OPERATION

- (1) Viewing angle varies with the change of liquid crystal driving voltage ( $V_o$ ). Adjust  $V_o$  to show the best contrast.
- (2) Driving the LCD in the voltage above the limit will shorten its lifetime.
- (3) Response time is greatly delayed at temperature below the operating temperature range. However, this does not mean the LCD will be out of the order. It will recover when it returns to the specified temperature range.
- (4) If the display area is pushed hard during operation, the display will become abnormal. However, it will return to normal if it is turned off and then on.
- (5) Condensation on terminals can cause an electrochemical reaction disrupting the terminal circuit. Therefore, this product must be used and stored within the specified condition of  $23\pm 5^{\circ}\text{C}$ ,  $45\pm 20\% \text{RH}$ .
- (6) When turning the power on, input each signal after the positive/negative voltage becomes stable.

## 12.5 SAFETY

- (1) It is recommended to crush damaged or unnecessary LCDs into pieces and wash them off with solvents such as acetone and ethanol, which should later be burned.
- (2) If any liquid leaks out of a damaged glass cell and comes in contact with the hands, wash off thoroughly with soap and water.

### 13. REVISION HISTORY

Version	Revise record	Date
1.0	Original version	05-01-01
2.0	Change specification format	05-11-21

## SAMPLE APPROVED REPORT

### (样品确认单)

SAMPLE MODEL NO. (样品型号)	GT2030
SAMPLE SERIES NUMBER NO. (样品序号)	
SAMPLE QUANTITY (样品数量)	
COLOR/TYPE (底色/类型)	FSTN/POSITIVE
VIEWING DIRECTION (视角)	6:00
DRIVING METHOD (驱动参数)	1/65Duty, 1/9Bias
LOGIC VOLTAGE (IC 工作电压)	3.0V
LCD VOP (LCD 驱动电压)	8.5V
OPERATING TEMP. (操作温度)	-20~70
STORAGE TEMP. (储存温度)	-30~80
POLARIZER----FRONT (首偏光片)	TRANSMISSIVE
POLARIZER----BACK (后偏光片)	TRANSFLECTIVE
CONTROLLER/DRIVER IC(控制/驱动 IC)	ST7565P
BACKLIGHT COLOR/TYPE (背光源类型/颜色)	LED/YELLOW-GREEN
DRAWING REV/NO./QUANTITY (图纸版本/数量)	
SPECIFICATION (规格书 份数)	
REMARKS : (备注)	
WRIT BY : _____ DATE : _____ APROV BY : _____ DATE : _____	
CUSTOMER'S APPROVAL (客户确认) :	
1) FUNCTION (功能) : <input type="checkbox"/> OK <input type="checkbox"/> N.G.	
2) DRIVER CONDITION (驱动条件) : <input type="checkbox"/> OK <input type="checkbox"/> N.G.	
3) DISPLAY MODE (显示模式) : <input type="checkbox"/> OK <input type="checkbox"/> N.G.	
4) VIEWING ANGLE (视角) : <input type="checkbox"/> OK <input type="checkbox"/> N.G.	
5) BACKLIGHT (背光源) : <input type="checkbox"/> OK <input type="checkbox"/> N.G.	
6) DISPLAYING PATTERN (显示效果) : <input type="checkbox"/> OK <input type="checkbox"/> N.G.	
CUSTOMER'S CONCLUSIONS (客户意见) : _____	
_____	
_____	
CUSTOMER'S SIGNATURE (客户签名) : _____ DATE (日期) : _____	