

Features

- High Luminous LEDs
- 10mm Standard Directivity
- Superior Weather-resistance
- UV Resistant Epoxy
- Water Clear Type

Applications

- Electronic Signs And Signals
- Illuminations
- Medical instruments light
- Other Lighting

Outline Dimension

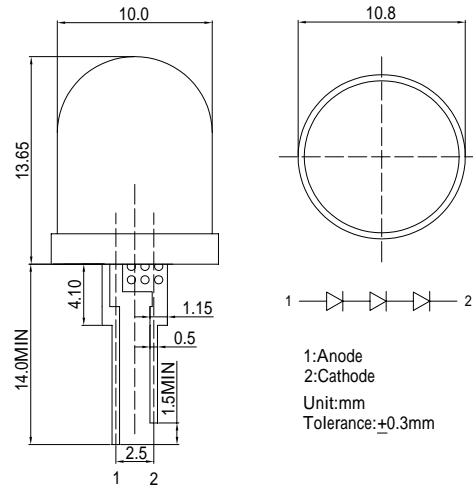

Absolute Maximum Rating (Ta=25 °C)

Item	Symbol	Value	Unit
DC Forward Current	I_F	25	mA
Pulse Forward Current*	I_{FP}	100	mA
Reverse Voltage	V_R	15	V
Power Dissipation	P_D	270	mW
Operating Temperature	T_{opr}	-30 ~ +85	
Storage Temperature	T_{stg}	-40 ~ +100	
Lead Soldering Temperature	T_{sol}	260 /5sec	-

*Pulse width Max 10ms , Duty ratio max 1/10

Directivity

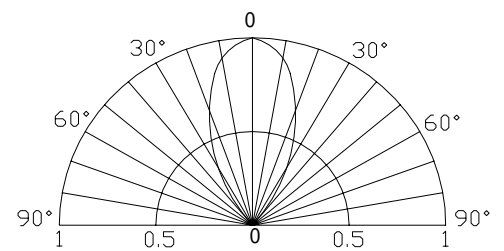

Electrical -Optical Characteristics (Ta=25 °C)

Item	Symbol	Condition	Min.	Typ.	Max.	Unit
DC Forward Voltage	V_F	$I_F=20mA$	8.7	9.3	10.8	V
DC Reverse Current	I_R	$V_R=15V$	-	-	10	μA
Luminous Intensity*	I_v	$I_F=20mA$	-	3800	-	mcd
Chromaticity Coordinates*	x	$I_F=20mA$	-	0.45	-	
	y	$I_F=20mA$	-	0.17	-	
50% Power Angle	$2\theta_{1/2}$	$I_F=20mA$	-	50	-	deg

*1 Tolerance of chromaticity coordinates ±10%

*2 Tolerance of luminous intensity is ±15%