

CDBW0520L-HF Thru. CDBW0540-HF

Reverse Voltage: 20 to 40 Volts

Forward Current: 0.5 Amp

RoHS Device

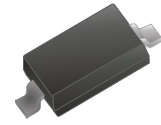

Features

- Halogen free.
- Low turn on voltage.
- Fast switching.
- PN junction guard ring for transient and ESD protection.

Mechanical data

- Case: SOD-123, molded plastic.
- Terminals: solderable per MIL-STD-750, method 2026.
- Polarity: Color band denotes cathode end.
- Weight: 0.0097 gram(approx.).

Marking

CDBW0520L-G: SD

CDBW0530-G: SE

CDBW0540-G: SF

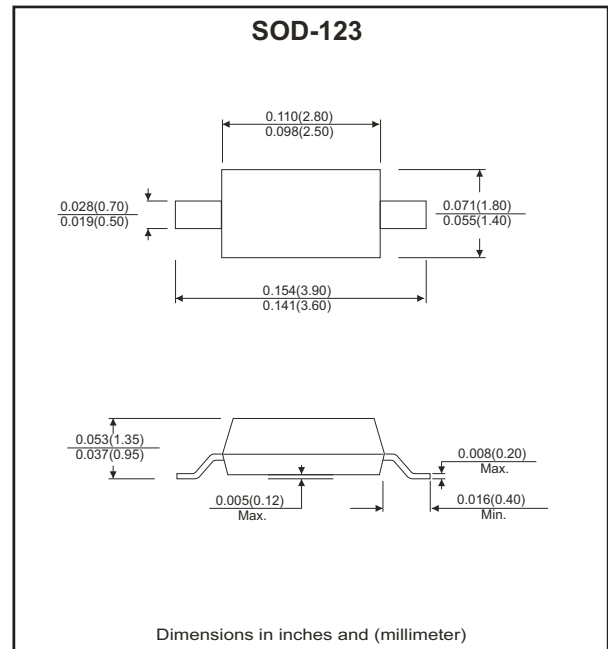

Maximum Ratings and Electrical Characteristics(At Ta=25°C, unless otherwise noted)

Parameter	Symbol	CDBW0520L-HF	CDBW0530-HF	CDBW0540-HF	Units
Max. repetitive peak reverse voltage	V _{RRM}	20	30	40	V
Max. DC blocking voltage	V _{DC}	20	30	40	V
Max. RMS voltage	V _{RMS}	14	21	28	V
Peak surge forward current, 8.3ms single half sine-wave superimposed on rate load (JEDEC method)	I _{FSM}	5.5			A
Max. average forward current	I _O	0.5			A
Max. forward voltage	V _F	0.3@I _F =0.1A 0.385@I _F =0.5A	0.375@I _F =0.1A 0.430@I _F =0.5A	0.51@I _F =0.5A 0.62@I _F =1.0A	V
Max. reverse current	I _R	0.075@V _R =10V 0.25@V _R =20V	0.02@V _R =15V 0.13@V _R =30V	0.01@V _R =20V 0.02@V _R =40V	mA
Max. thermal resistance (Note 1)	R _{θJA} R _{θJL}	206 150			°C/W
Max. operating junction temperature	T _J	125			°C
Storage temperature	T _{STG}	-55 to +125			°C

Notes: 1. Thermal resistance from junction to ambient and junction to lead, mounted on P.C.B. with 0.2×0.2 inch copper pad area.

2

RATING AND CHARACTERISTIC CURVES (CDBW0520L-HF thru CDBW0540-HF)

Fig.1 Forward Characteristics

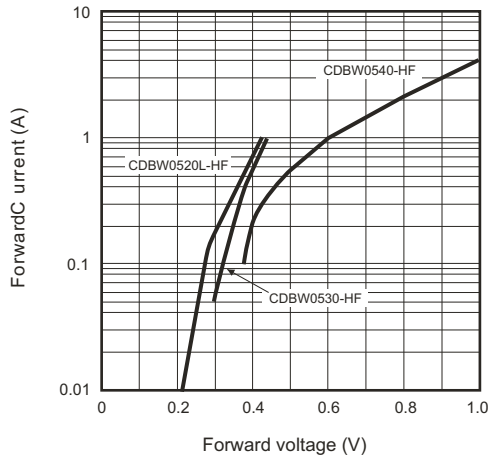

Fig.2 Current Derating Curve

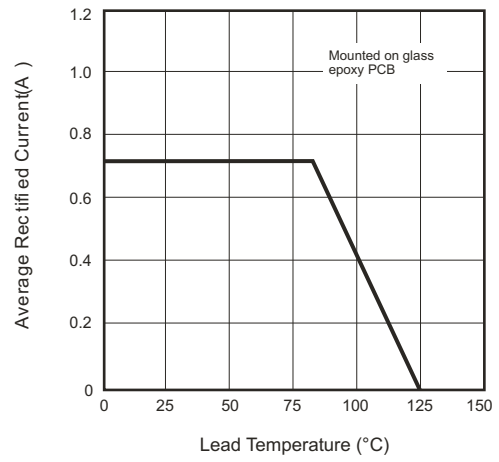
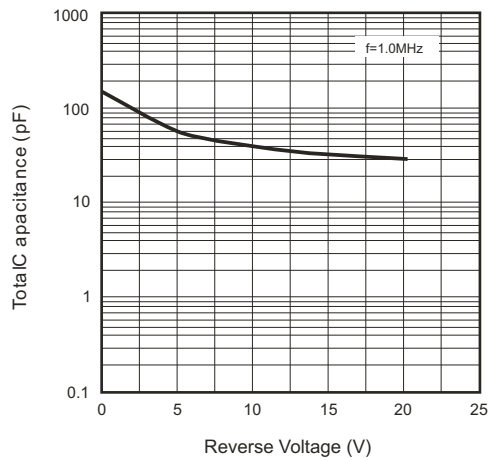
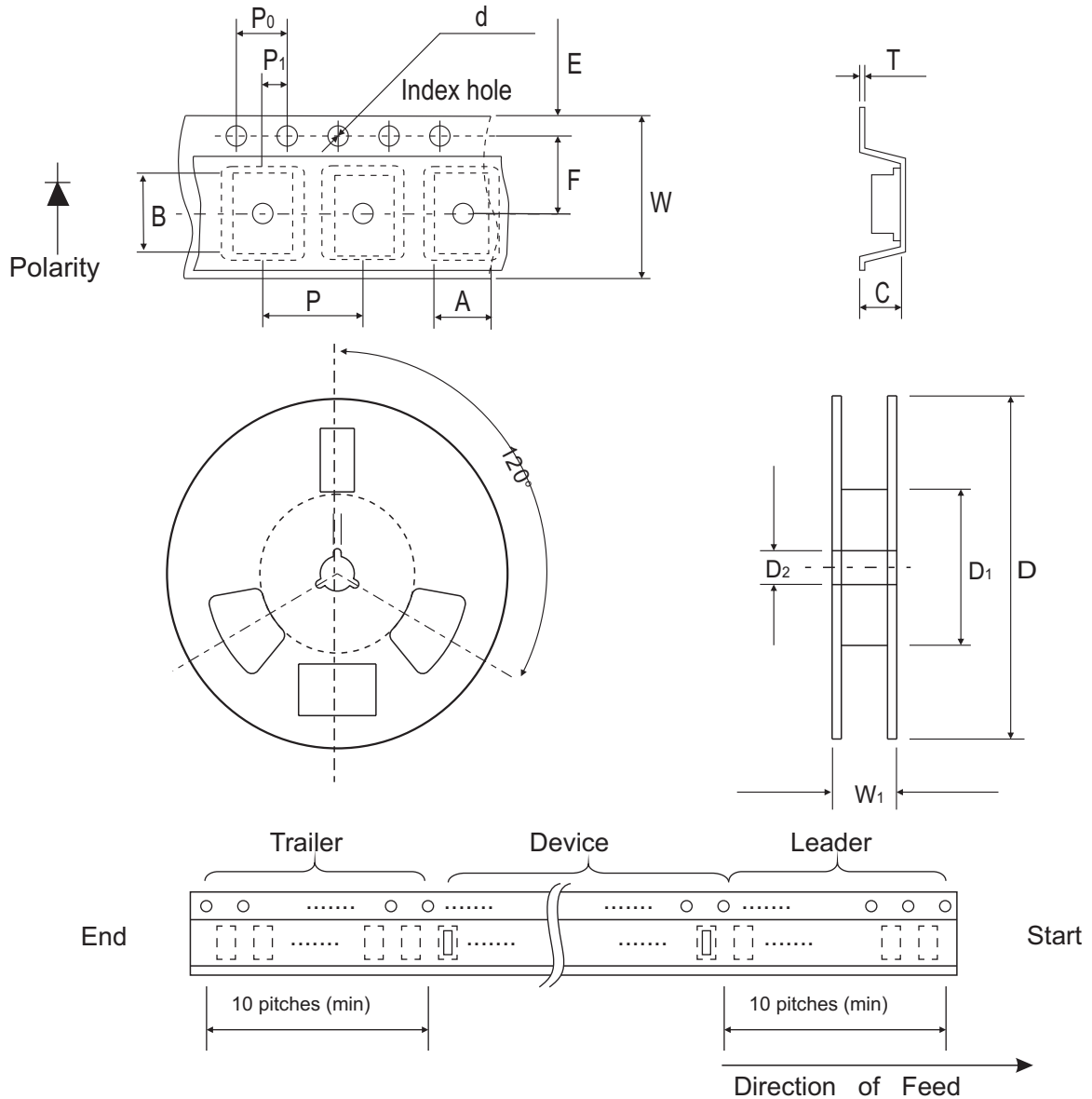

Fig.3 Total Capacitance vs. Reverse voltage



Reel Taping Specification



SOD-123	SYMBOL	A	B	C	d	D	D1	D2
	(mm)	1.90 ± 0.10	4.00 ± 0.10	1.50 ± 0.10	1.55 ± 0.10	178 ± 1.00	50.0 MIN.	13.0 ± 0.20
	(inch)	0.075 ± 0.04	0.157 ± 0.04	0.059 ± 0.04	0.061 ± 0.04	7.00 ± 0.039	1.968 MIN.	0.512 ± 0.079

SOD-123	SYMBOL	E	F	P	P0	P1	W	W1
	(mm)	1.75 ± 0.10	3.50 ± 0.05	4.00 ± 0.10	4.00 ± 0.10	2.00 ± 0.05	8.00 ± 0.30	14.4 MAX.
	(inch)	0.069 ± 0.004	0.138 ± 0.002	0.157 ± 0.004	0.157 ± 0.004	0.079 ± 0.002	0.315 ± 0.011	0.567 MAX

Marking Code

Part Number	Marking Code
CDBW0520L-HF	SD
CDBW0530-HF	SE
CDBW0540-HF	SF

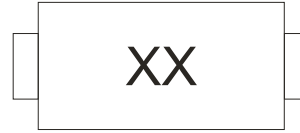

xx = Product type marking code

Suggested PAD Layout

SIZE	SOD-123	
	(mm)	(inch)
A	3.35	0.132
B	0.80	0.032
C	1.00	0.039
D	5.02	0.198
E	1.67	0.066

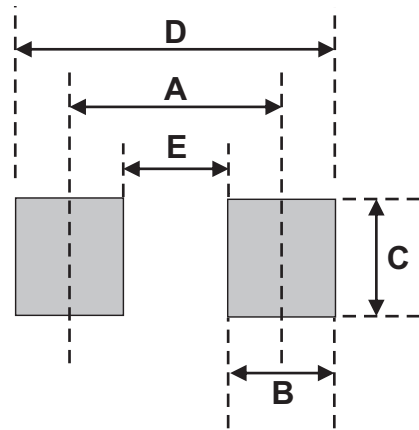

Standard Package

Case Type	Qty per Reel	Reel Size
	(Pcs)	(inch)
SOD-123	3000	7