

Dual 1.5MHz, 800mA Synchronous Step-Down Converter

DESCRIPTION

The EUP3409 contains two independent 1.5MHz constant frequency, current mode, PWM step-down converters. Each converter integrates a main switch and a synchronous rectifier for high efficiency without an external Schottky diode. The EUP3409 is ideal for powering portable equipment that runs from a single cell Lithium-Ion (Li+) battery. Each converter can supply 800mA of load current from a 2.5V to 5.5V input voltage. The output voltage can be regulated as low as 0.6V. The EUP3409 can also run at 100% duty cycle for low dropout applications.

FEATURES

- Up to 96% Efficiency
- 1.5MHz Constant Switching Frequency
- 800mA Load Current on Each Channel
- 2.5V to 5.5V Input Voltage Range
- Output Voltage as Low as 0.6V
- 100% Duty Cycle in Dropout
- Current Mode Operation
- Short Circuit Protection
- Thermal Fault Protection
- <math><1\mu\text{A}</math> Shutdown Current
- Soft Start Function
- Space Saving 10-Pin TDFN Package
- RoHS Compliant and 100% Lead(Pb)-Free

APPLICATIONS

- Cellular and Smart Phones
- Microprocessors and DSP Core Supplies
- PDAs and Portable Media Players
- Wireless and DSL Modems
- Digital Still and Video Cameras

Typical Application Circuit

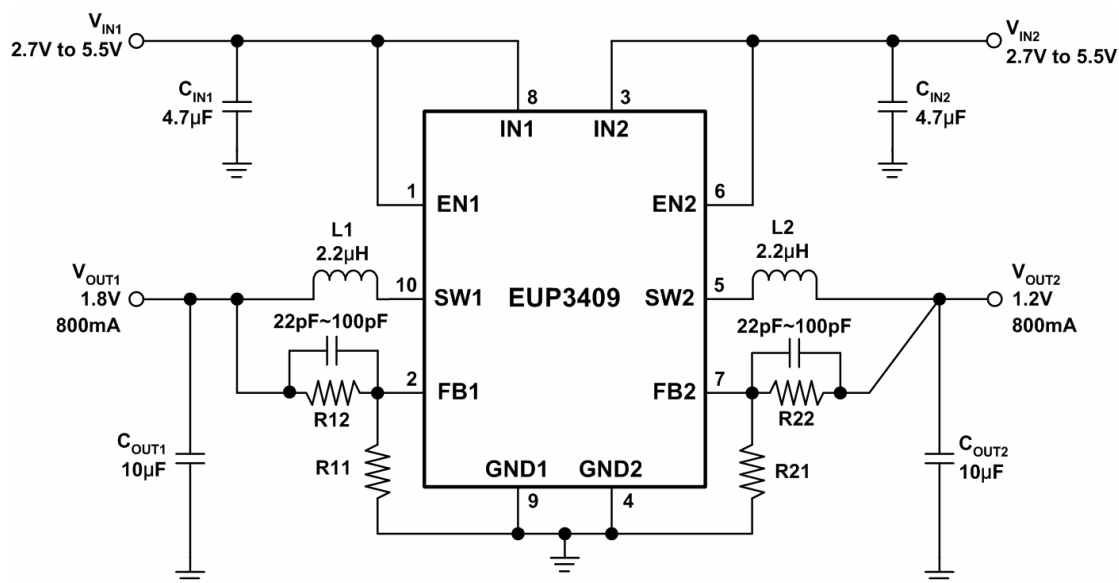

Figure 1. Adjustable Voltage Regulator

Block Diagram

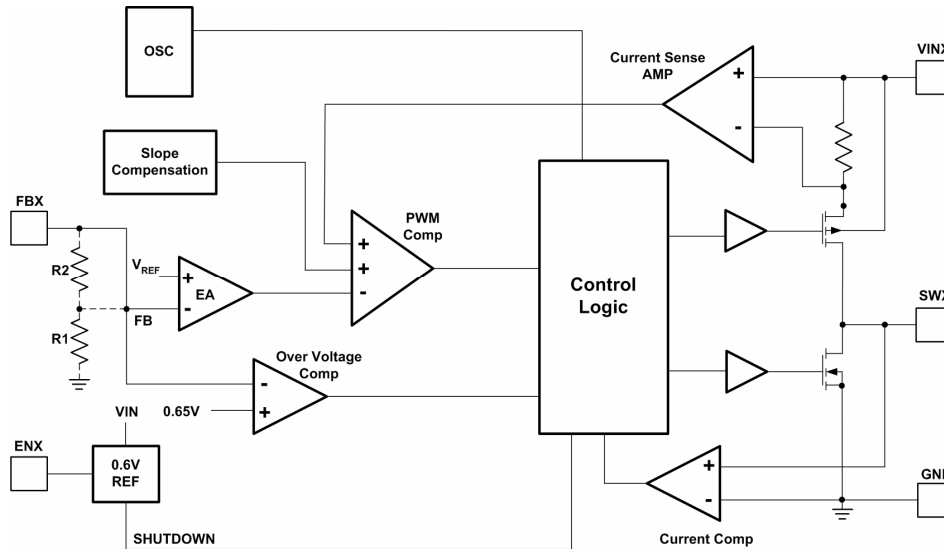

Figure 2.

Pin Configurations

Package Type	Pin Configurations
TDFN-10	<p>(TOP VIEW)</p>

Pin Description

PIN	Pin	DESCRIPTION
EN1	1	Channel 1 Enable Control Input. Drive EN1 above 1.5V to turn on the Channel 1. Drive EN1 below 0.3V to turn it off (shutdown current < 0.1μA). Do not leave EN1 floating.
FB1	2	Channel 1 Feedback.
IN2	3	Channel 2 Supply Input.
GND2	4	Ground 2.
SW2	5	Channel 2 Switch Node Connection to Inductor. This pin connects to the drains of the internal main and synchronous power MOSFET switches.
EN2	6	Channel 2 Enable Control Input. Drive EN2 above 1.5V to turn on the Channel 2. Drive EN2 below 0.3V to turn it off (shutdown current < 0.1μA). Do not leave EN2 floating.
FB2	7	Channel 2 Feedback.
IN1	8	Channel 1 Supply Input.
GND1	9	Ground 1.
SW1	10	Channel 1 Switch Node Connection to Inductor. This pin connects to the drains of the internal main and synchronous power MOSFET switches.

Ordering Information

Order Number	Package Type	Marking	Operating Temperature range
EUP3409JIR1	TDFN-10	XXXXX P3409 20	-40 °C to 85°C

EUP3409

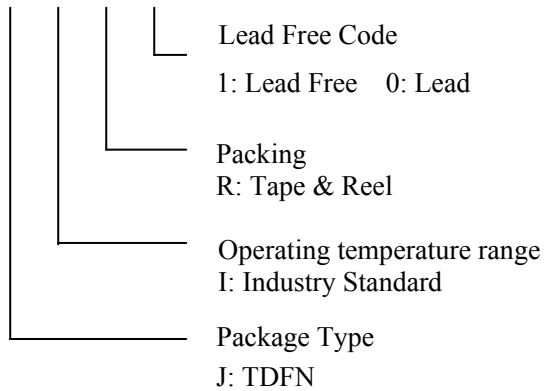

Absolute Maximum Ratings

- V_{INX} to GND ----- -0.3V to 6V
- V_{SWX} to GND ----- -0.3V to $V_{INX}+0.3V$
- V_{FBX}, V_{ENX} to GND ----- -0.3V to V_{INX}
- Junction Temperature ----- 125°C
- Storage Temperature ----- -65°C to 150°C
- Lead Temp (Soldering, 10sec) ----- 260°C

Recommended Operating Conditions

- Supply Voltage, V_{INX} ----- 2.5V to 5.5V
- Output Voltage, V_{OUTX} ----- 0.6V to 5V
- Operating Temperature ----- -40°C to 85°C

Electrical Characteristics

$V_{INX}=V_{ENX}=3.6V, T_A=25^\circ C$, Unless otherwise specified.

Symbol	Parameter	Conditions	EUP3409			Unit
			Min	Typ	Max.	
V_{IN}	Input Voltage Range		2.5		5.5	V
I_{FB}	Feedback Current			±30		nA
I_Q	Each converter Supply Current	$V_{FBX}=0.5V, SWX$ Open		270	370	µA
I_{SHDN}	Each converter Shutdown Current	$V_{ENX}=0V, V_{INX}=4.2V$			1	µA
I_{PK}	Peak Inductor Current	$V_{INX}=3V, V_{FBX}=0.5V$	1.05	1.25		A
V_{FB}	Regulator Feedback Voltage (Note 1)	$T_A=25$	0.588	0.6	0.612	V
		$-40 \leq T_A \leq 85$	0.585	0.6	0.615	
ΔV_{OUT}	Output Voltage Line Regulation	$V_{INX}=2.5V$ to 5.5V, $I_{LOAD}=0$		0.25	0.4	%/V
ΔV_{FB}	Reference Voltage Line Regulation	$V_{INX}=2.5V$ to 5.5V		0.25	0.4	%/V
$\Delta V_{LOADREG}$	Output Voltage Load Regulation	$I_{LOAD}=0$ to 800mA		0.5		%
f_{OSC}	Each converter Oscillator Frequency	$V_{FBX}=0.6V$	1.2	1.5	1.8	MHz
		$V_{FBX}=0$		0.7		
R_{PFET}	$R_{DS(ON)}$ of P-Channel FET	$I_{SWX}=200mA$		0.28	0.4	Ω
R_{NFET}	$R_{DS(ON)}$ of N-Channel FET	$I_{SWX}= -200mA$		0.3	0.4	Ω
I_{LSW}	SW Leakage Current	$V_{ENX}=0V, V_{SWX}=0$ or 5V, $V_{INX}=5V$			±1	µA
V_{EN}	EN Threshold	$-40 \leq T_A \leq 85$	0.3	1.0	1.5	V

Note 1: The EUP3409 is tested in a proprietary test mode that connects FBX to the output of the error amplifier.

Typical Operating Characteristics

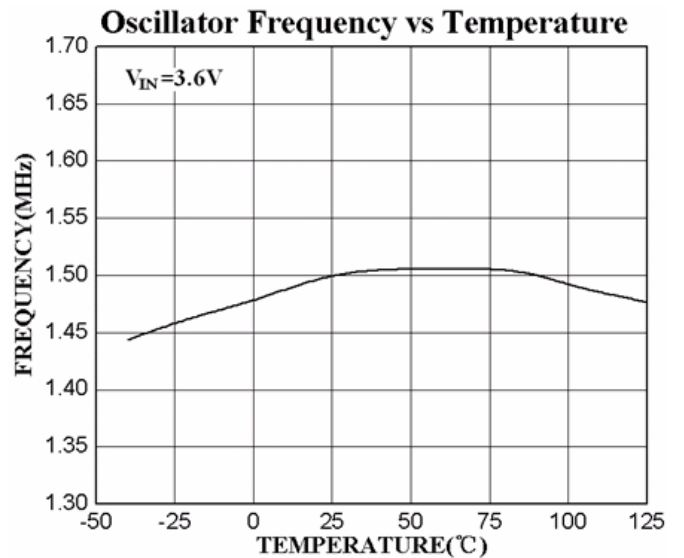
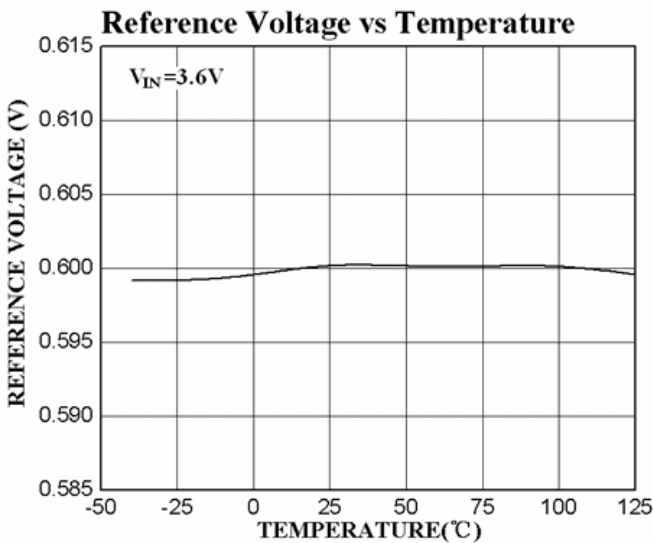
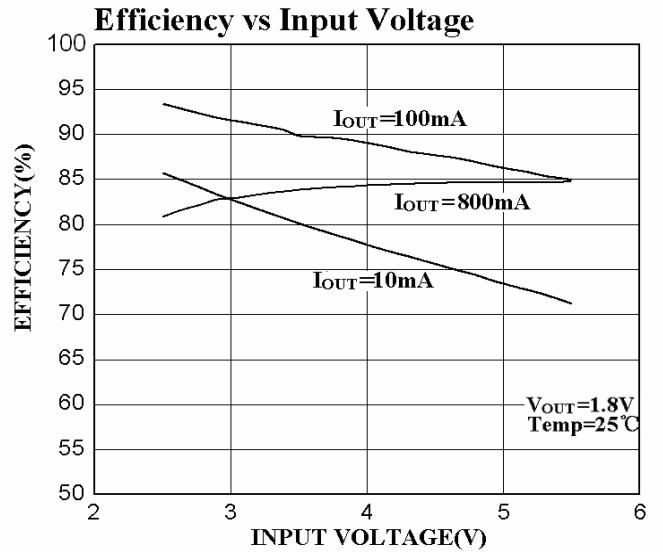
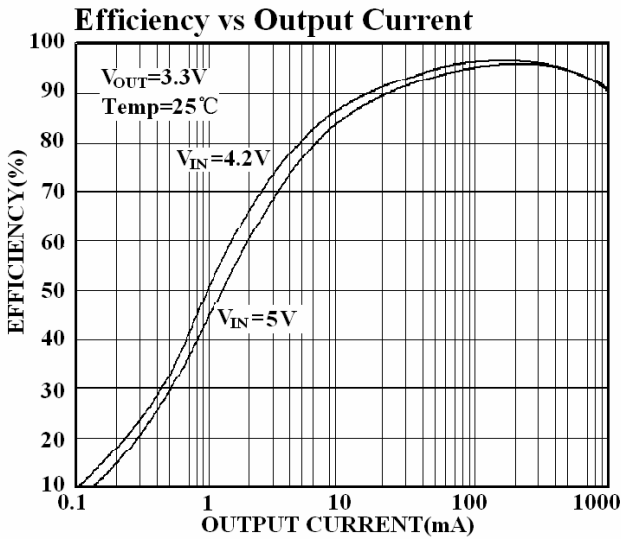
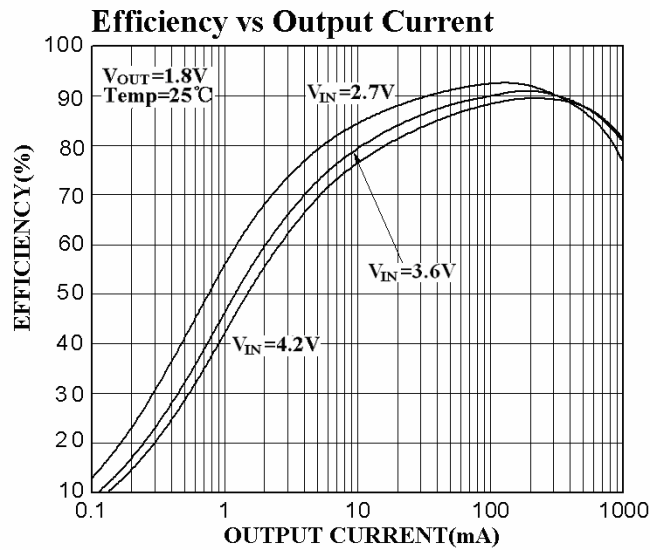
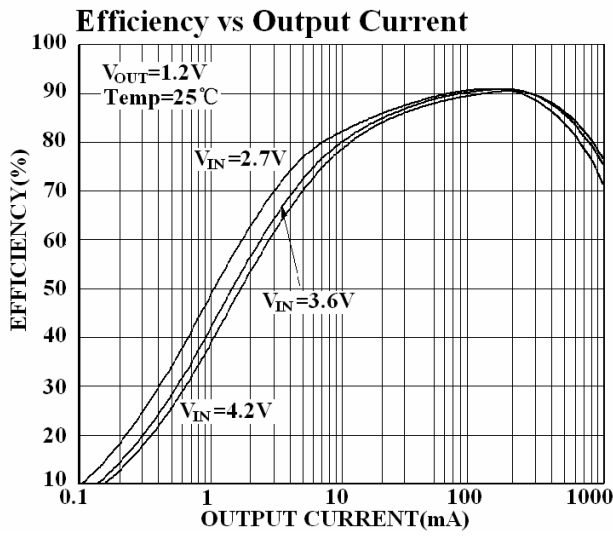

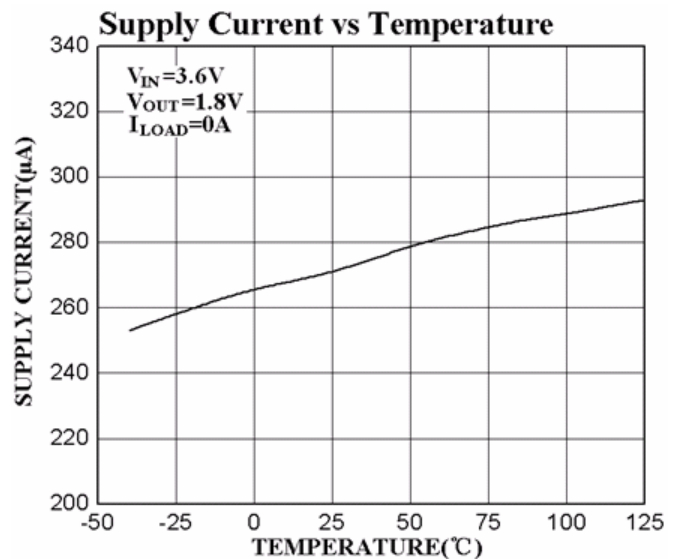
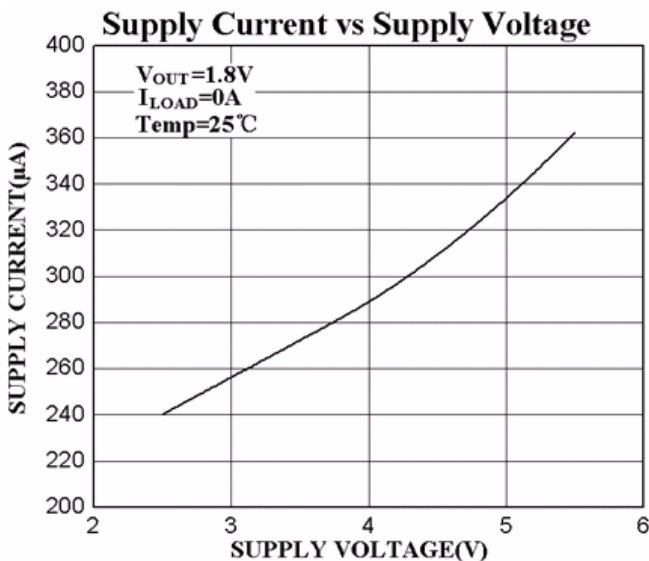
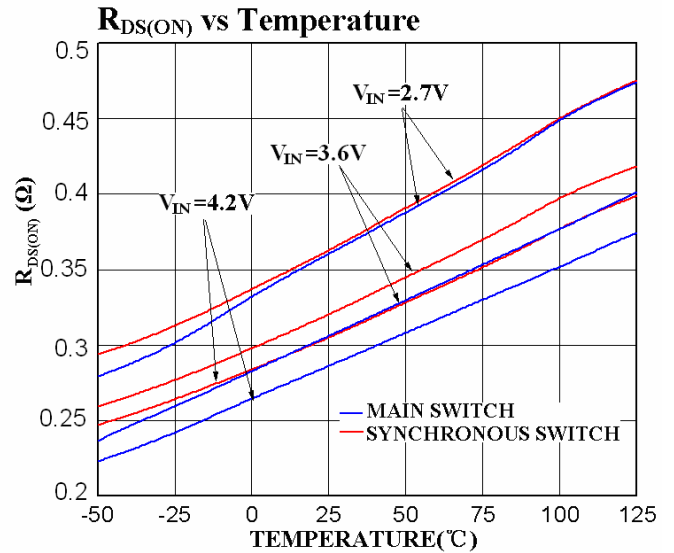
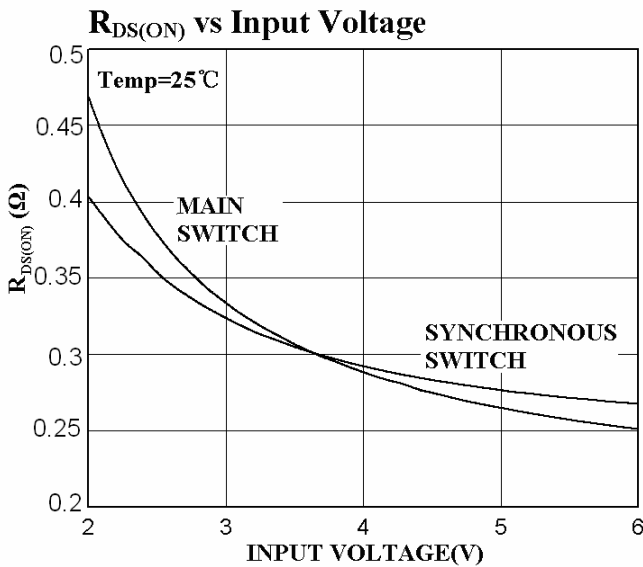
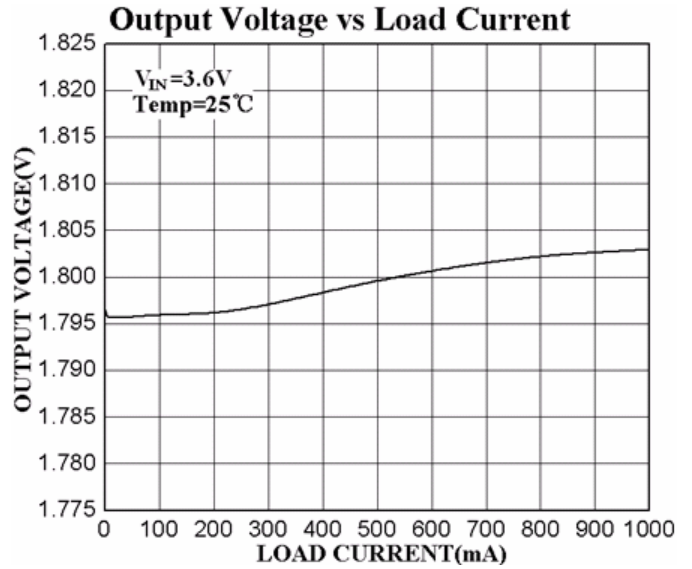
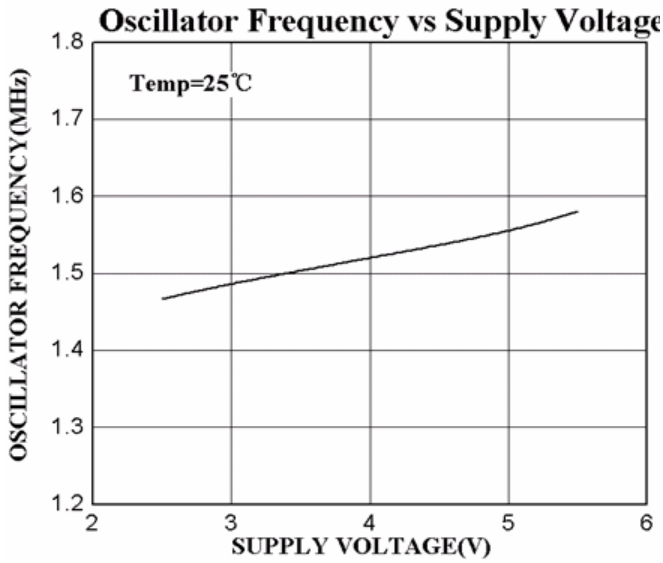

Discontinuous Operation

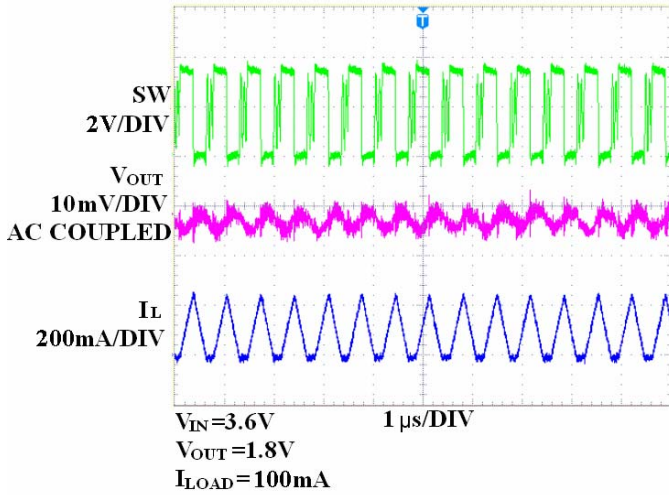

Normal Operation

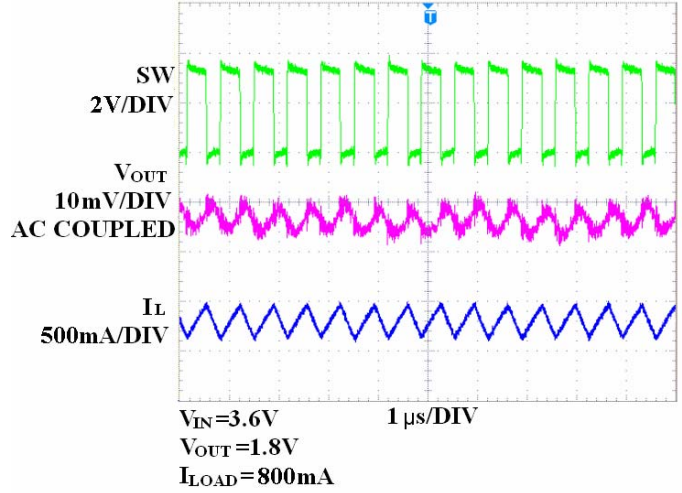

Start-Up from Shutdown

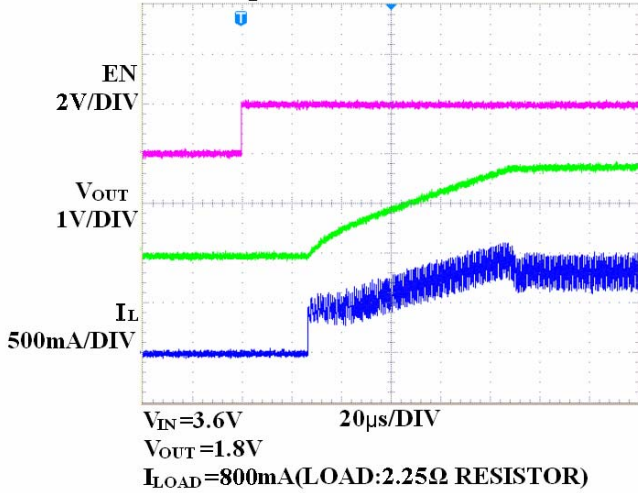

Load Step

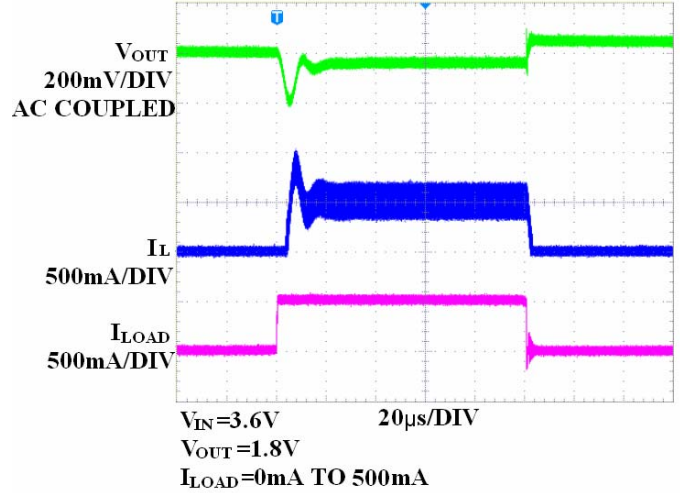

Load Step

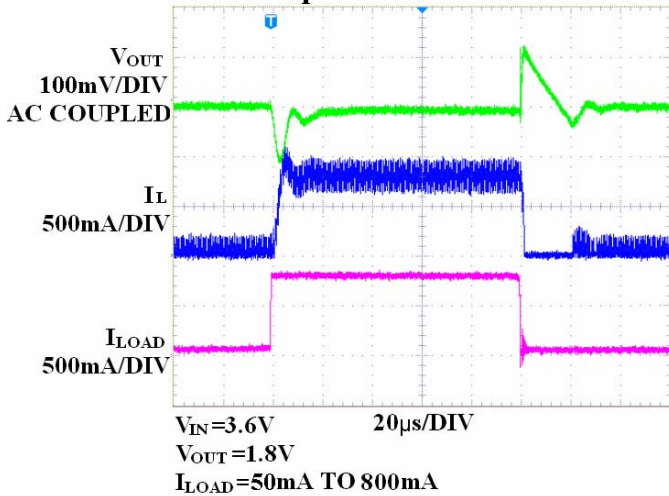

Load Step

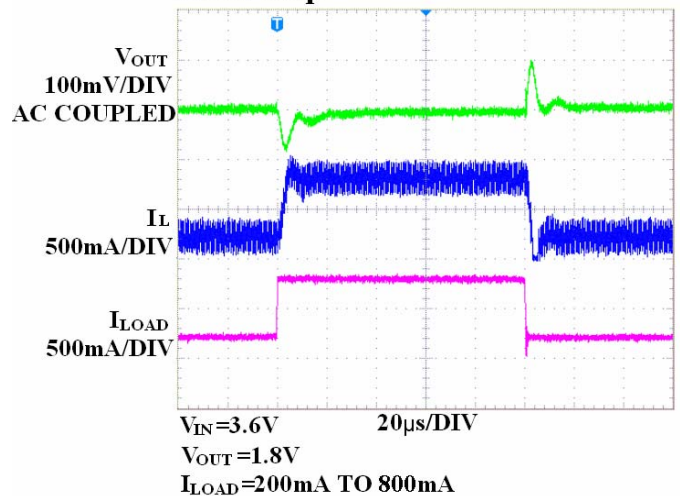

Operation

The EUP3409 has dual independent slop-compensated constant frequency current mode PWM step-down converters. Both the main (P-channel MOSFET) and synchronous (N-channel MOSFET) switches are internal. During normal operation, the EUP3409 regulates output voltage by switching at a constant frequency and then modulating the power transferred to the load each cycle using PWM comparator. The duty cycle is controlled by three weighted differential signals: the output of error amplifier, the main switch sense voltage and the slope-compensation ramp. It modulates output power by adjusting the inductor-peak current during the first half of each cycle. An N-channel, synchronous switch turns on during the second half of each cycle (off time). When the inductor current starts to reverse or when the PWM reaches the end of the oscillator period, the synchronous switch turns off. This keeps excess current from the output capacitor to GND, or through the main and synchronous switch to GND.

Application Information

Inductor Selection

The output inductor is selected to limit the ripple current to some predetermined value, typically 20%~40% of the full load current at the maximum input voltage. Large value inductors lower ripple currents. Higher V_{IN} or V_{OUT} also increases the ripple current as shown in equation. A reasonable starting point for setting ripple current is $\Delta I_L=320\text{mA}$ (40% of 800mA).

$$\Delta I_L = \frac{1}{(f)(L)} V_{OUT} \left(1 - \frac{V_{OUT}}{V_{IN}} \right)$$

The DC current rating of the inductor should be at least equal to the maximum load current plus half the ripple current to prevent core saturation. Thus, a 960mA rated inductor should be enough for most applications (800mA+160mA). For better efficiency, choose a low DC-resistance inductor.

C_{IN} and C_{OUT} Selection

In continuous mode, the source current of the top MOSFET is a square wave of duty cycle V_{OUT}/V_{IN} . The primary function of the input capacitor is to provide a low impedance loop for the edges of pulsed current drawn by the EUP3409. A low ESR input capacitor sized for the maximum RMS current must be used. The size required will vary depending on the load, output voltage and input voltage source impedance characteristics. A typical value is around 4.7 μF .

The input capacitor RMS current varies with the input voltage and the output voltage. The equation for the maximum RMS current in the input capacitor is:

$$I_{RMS} = I_O \times \sqrt{\frac{V_O}{V_{IN}} \times \left(1 - \frac{V_O}{V_{IN}} \right)}$$

The output capacitor C_{OUT} has a strong effect on loop stability.

The selection of C_{OUT} is driven by the required effective series resistance (ESR).

ESR is a direct function of the volume of the capacitor; that is, physically larger capacitors have lower ESR. Once the ESR requirement for C_{OUT} has been met, the RMS current rating generally far exceeds the $I_{RIPPLE(P-P)}$ requirement. The output ripple ΔV_{OUT} is determined by:

$$\Delta V_{OUT} \cong \Delta I_L \left(\text{ESR} + \frac{1}{8fC_{OUT}} \right)$$

When choosing the input and output ceramic capacitors, choose the X5R or X7R dielectric formulations. These dielectrics have the best temperature and voltage characteristics of all the ceramics for a given value and size.

Output Voltage Programming

The output voltage is set by a resistive divider according to the following formula:

$$V_{OUT} = 0.6V \left(1 + \frac{R2}{R1} \right)$$

The external resistive divider is connected to the output, allowing remote voltage sensing as shown in below figure.

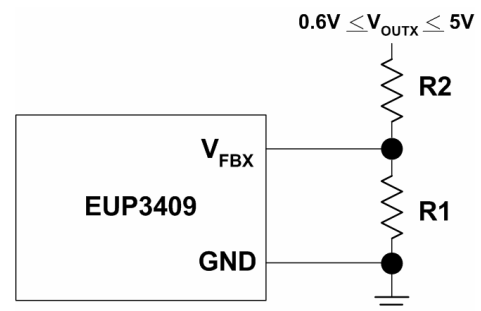

Thermal Considerations

To avoid the EUP3409 from exceeding the maximum junction temperature, the user will need to do a thermal analysis. The goal of the thermal analysis is to determine whether the operating conditions exceed the maximum junction temperature of the part. The temperature rise is given by:

$$T_R = (P_D)(\theta_{JA})$$

Where $P_D = I_{LOAD}^2 \times R_{DS(ON)}$ is the power dissipated by the regulator ; θ_{JA} is the thermal resistance from the junction of the die to the ambient temperature.

The junction temperature, T_J , is given by:

$$T_J = T_A + T_R$$

Where T_A is the ambient temperature.

T_J should be below the maximum junction temperature of 125°C.

PC Board Layout Checklist

When laying out the printed circuit board, the following guidelines should be used to ensure proper operation of the EUP3409.

1. The input capacitor C_{INX} should connect to V_{INX} as closely as possible. This capacitor provides the AC current to the internal power MOSFETs.
2. The power traces, consisting of the GND trace, the SW trace and the V_{INX} trace should be kept short, direct and wide.
3. The FBx pin should connect directly to the feedback resistors. The resistive divider R11/R12 and R21/R22 must be connected between the C_{OUTX} and ground.
4. Keep the switching node, SWX, away from the sensitive FBx node.

Packaging Information

TDFN-10

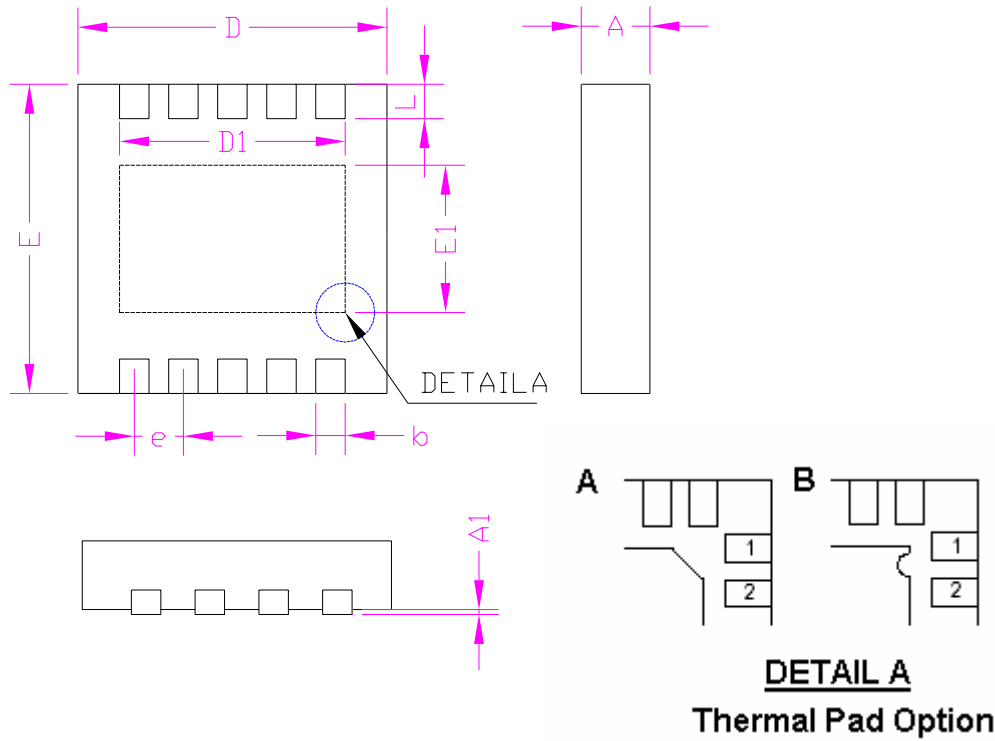

SYMBOLS	MILLIMETERS		INCHES	
	MIN.	MAX.	MIN.	MAX.
A	0.70	0.80	0.028	0.031
A1	0.00	0.05	0.000	0.002
D	2.90	3.10	0.114	0.122
E1	1.70		0.067	
E	2.90	3.10	0.114	0.122
L	0.30	0.50	0.012	0.020
b	0.18	0.30	0.007	0.012
e	0.50		0.020	
D1	2.40		0.094	