

## Product Features

- Small size by using simple matching circuit board
- High Efficiency
- Single Supply Voltage
- High Linearity, 10W Power
- Heat sink 99.9% copper, gold plate
- High Productivity
- Low Manufacturing Cost
- GaAs MESFET

## Application

- GSM Repeater
- RF Sub-Systems
- Base Station



Package : DP-36

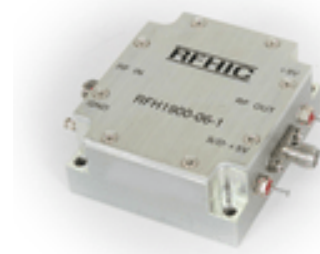

## Description

The power amplifier module is designed for base stations and cell extenders as cellular and GSM , IMT-2000, ISM, MMDS frequency systems.

GaAs MESFET is used and attached on a copper sub carrier. It is connected by using bias and in/out matching circuit method with gold wire bonding.

The bias and matching circuit are designed much simpler than other circuits for silicon IC's, LDMOS because

GaAs MESFET is operated by low supply voltage whereas others are operated by high supply voltage.

For better thermal conductivity, enhanced mode PCB was used in the 99.9% copper gold plate heat sink.

This simplicity results cost competitiveness and performance enhancement.

## Specifications

PARAMETER	Min	Typ	Max
Frequency Range (MHz)	890 ~ 915		
Small Signal Gain (dB)	16		
Gain Flatness (Max.)	± 0.5dB @ 50MHz BW		
Gain Variation Over Temp		± 0.5dB	± 1.0dB
VSWR (Input)	2 : 1		
Output P1dB	37 dBm	38 dBm	
CDMA Power (1 FA)	32 dBm		
Vcc / Idc (CDMA Only)	9V / 1.2A		
OIP3 @ tone / 27 dBm	49 dBm	50 dBm	
Noise Figure (Typ.)	5 dB		
Shut Down (On/Off)	+5V @ 25µA / 0V		
In/Out Connectors	SMA Female (50 Ω)		
Operating Temp Range	-20°C ~ +70°C		
Dimensions (W×L×H)	29.0 × 30.2 × 9.0 [mm] (RFM) 48.0 × 54.2 × 22.0 [mm] (RFH)		

### NOTE

- \* CDMA : 1.23MHz symbol rate ; Forward Link ; 9 Channels, Multi tone Available
  - @ ±750KHz offset in 30KHz resolution bandwidth
  - @ ±1.98MHz offset in 30KHz resolution bandwidth
- \* RFM : Internally Matched Module
- \* RFH : Housing Type
  - : RF Connector
  - : SMA Female

## Performance Charts ( $V_d=9V$ , $I_d=1.2A$ , $T=25^\circ C$ )

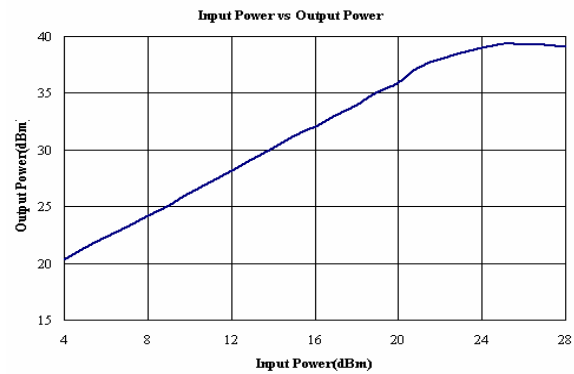
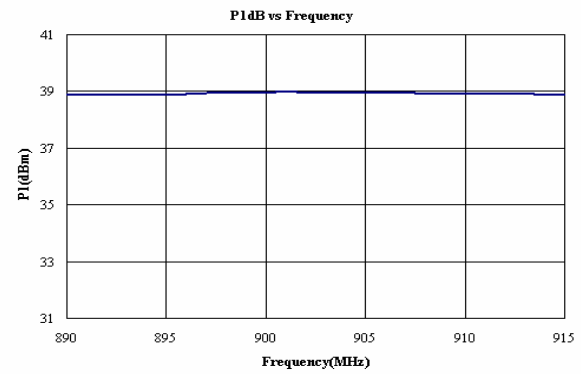
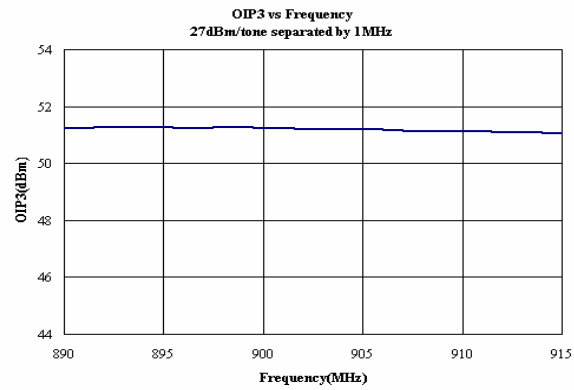
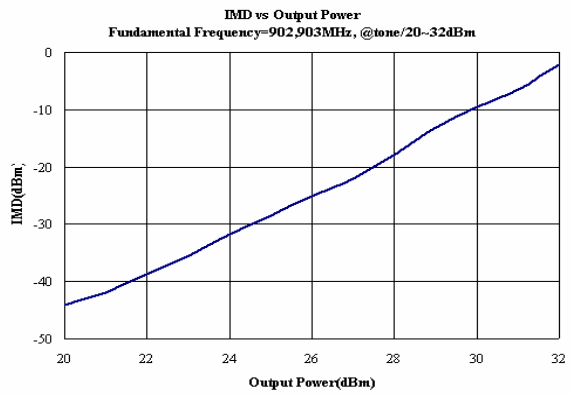
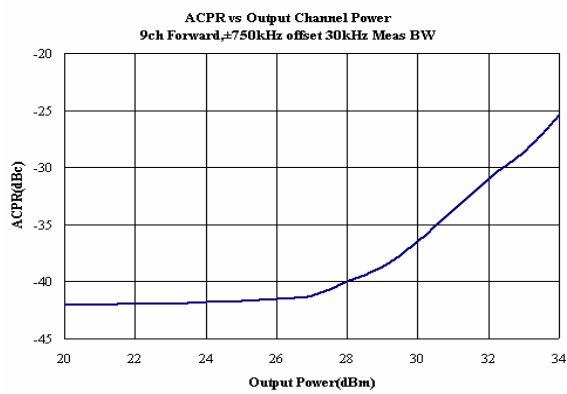
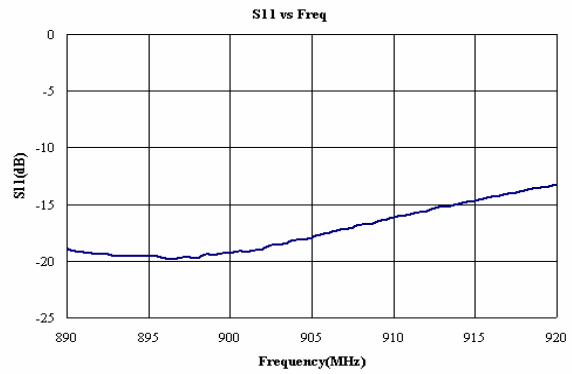
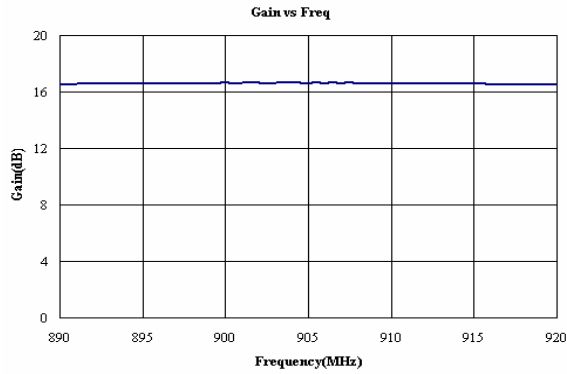

## Package Dimensions (Type: DP-36)

Unit :  $\frac{\text{mm}}{\text{[inch]}}$     Tolerance :  $\pm \frac{0.2}{.008}$

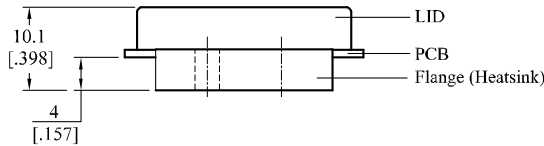
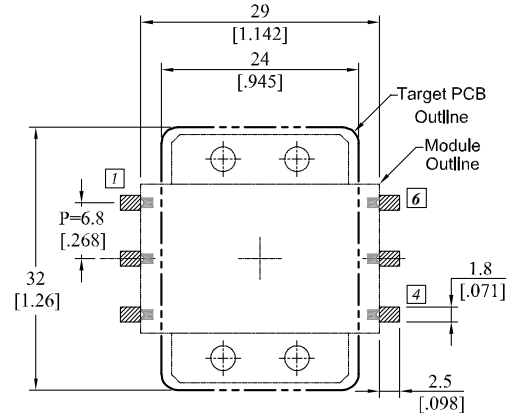
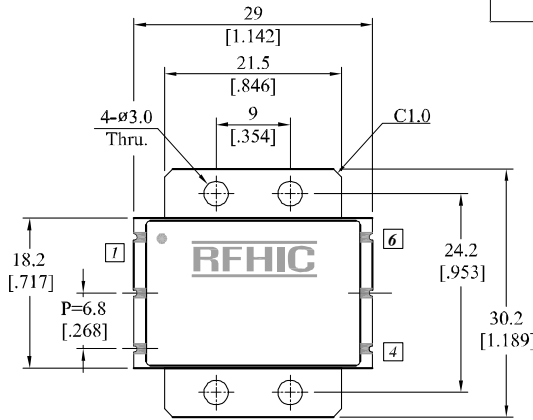

Pin NO	Function	Pin NO	Function
1	GND	6	Vcc
2	RF IN	5	RF OUT
3	GND	4	E/N

## Installation Guideline

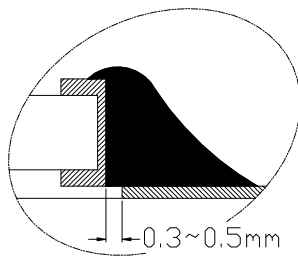
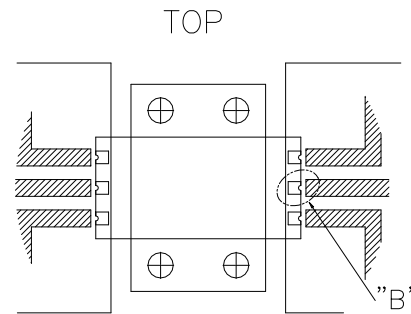
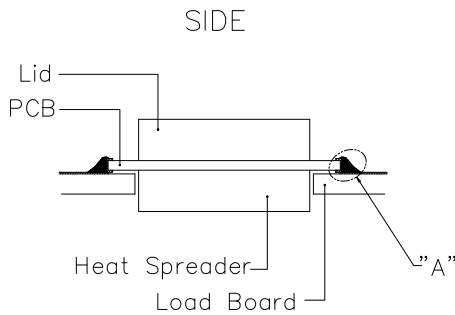

"A" (scale x10)

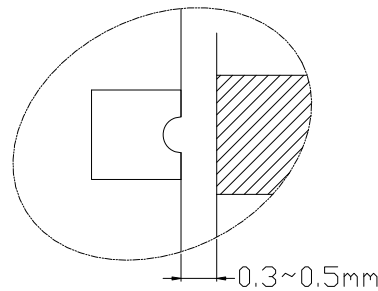

"B" (scale x10)

★ It can be easily removed with solder wick and other removable material.

RFHIC Corporation (RFHIC) reserves the right to make changes to any products herein or to discontinue any product at any time without notice. RFHIC do not assume any liability for the suitability of its products for any particular purpose, and disclaims any and all liability, including without limitation consequential or incidental damages. The product specifications herein expressed have been carefully checked and are assumed to be reliable. However, RFHIC disclaims liability for inaccuracies and strongly recommends buyers to verify that the information they are using is current before placing purchase orders. RFHIC products are not intended for use in life support equipment or application where malfunction of the product can be expected to result in personal injury or death. Buyer uses or sells such products for any such unintended or unauthorized application, buyer shall indemnify, protect and hold RFHIC and its directors, officers, stockholders, employees, representatives and distributors harmless against any and all claims arising out of such use. RFHIC's liability under or arising out of damages, claims of whatsoever kind and nature which RFHIC products could cause shall be limited in amount to the net purchase price of the products sold to buyer by RFHIC.