

## Product Features

- GaAs p-HEMT chip on board
- No matching circuit needed
- High Maximum input power(+25dBm)
- High IP3 & Low Noise
- Single Supply Voltage (+5V)
- Surface Mount Hybrid Type
- Tape & Reel Packaging
- Small Size, High Heatsink
- Alumina Substrate
- Pb Free / RoHS Standard

## Applications

- 2G & 3G Repeater
- Base Station
- PCS, CDMA, W-CDMA
- GSM, DCS, UMTS
- RF Sub-Systems



Package : CP-16A

## Descriptions

RFHIC's LOW Noise Amplifier series are all hybrid LNA type products which includes all matching for the convenience of customers. WL series are a wideband LNA used for up to 50~2200MHz. The structure of the device is built with GaAs p-HEMT die attached on a ceramic thick film substrate. The device is still smaller than the area one would use for the application notes all together. Depending on the part number, one can use this in different frequency applications. All LNA hybrids are possible to have custom frequency & spec without any additional NRE cost involved.

All RFHIC products are RoHS compliant.

## Electrical Specifications

Parameter	Units	WL1008-L	WL2208-L	WL1015-L	WL2215-L
Frequency Range	MHz	50~1000	50~2200	50~1000	50~2200
Small Signal Gain ( $S_{21}$ )	dB	16	15	16	15
Gain Flatness	dB	$\pm 1.0$	$\pm 2.0$	$\pm 1.0$	$\pm 2.0$
Input Return Loss ( $S_{11}$ )	dB	-15	-10	-15	-10
Output Return Loss ( $S_{22}$ )	dB	-5	-5	-5	-5
1dB Compression Point ( $P_{1dB}$ )	dBm	19	20	21	21
Output 3 <sup>rd</sup> Order Intercept Point (OIP3) (TYP.)	dBm	31	31	35	35
Noise Figure (TYP.)	dB	1.5	1.5	1.7	1.7
DC Supply Current ( $V_{dc}=+5V$ )	mA	100	100	160	160

### Test Condition

- ① Supply voltage = +5V, 50ohm System,  $T_a = 25^\circ C$
- ② OIP3 is measured with two tones, at an output power of +0dBm/tone separated by 1MHz.

**WL1008-L**

**S-Parameter**

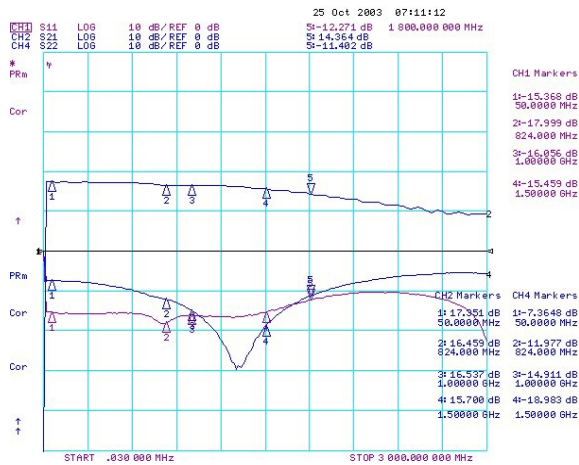

**Noise Figure**

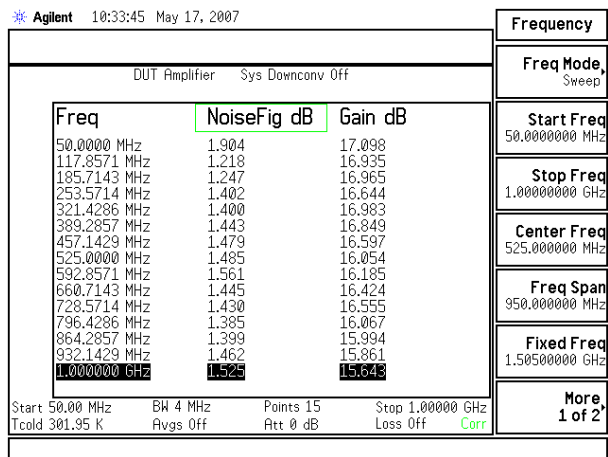

**OIP3(824MHz)**

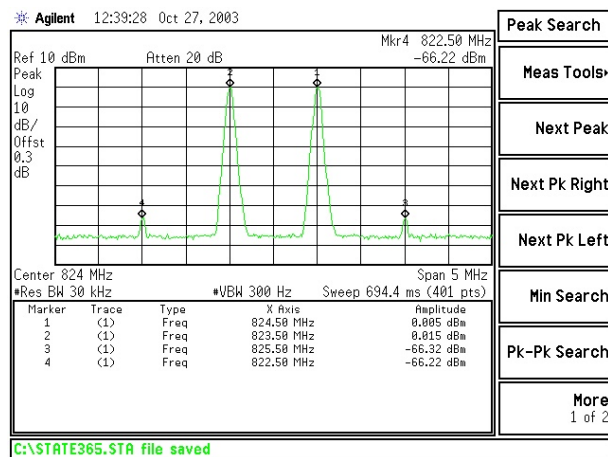

**OIP3(1500MHz)**

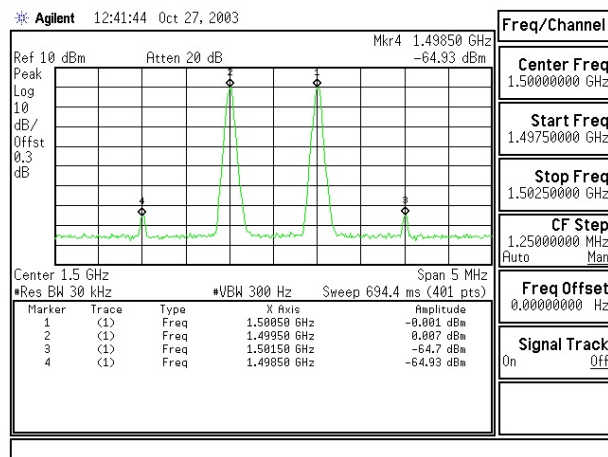

**P1dB(824MHz)**



**P1dB(1500MHz)**



**Absolute Maximum Ratings\***

PARAMETER	Unit	Rating	Remark
Device Voltage	V	+8	
RF Input Power	dBm	+25	
Operating Temperature	°C	-40 to +85	
Storage Temperature	°C	-50 to +125	

\* Operation of this device in excess of any one of these parameters may cause permanent damage.

**Functional Diagram**

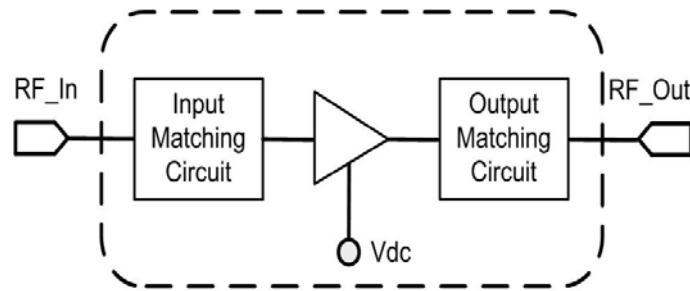

**Application Circuit**

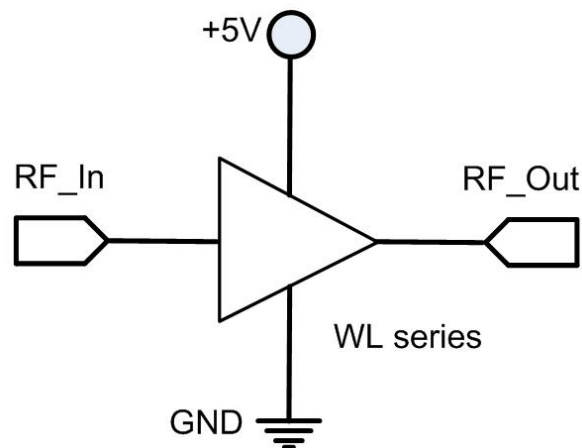

## Package Dimensions (Type: CP-16A)

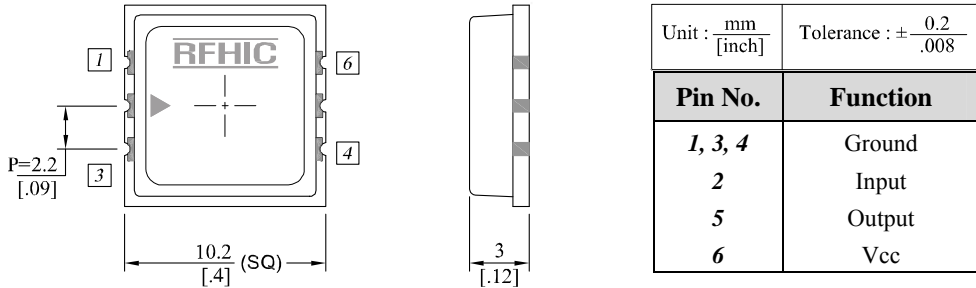

### Recommended Pattern

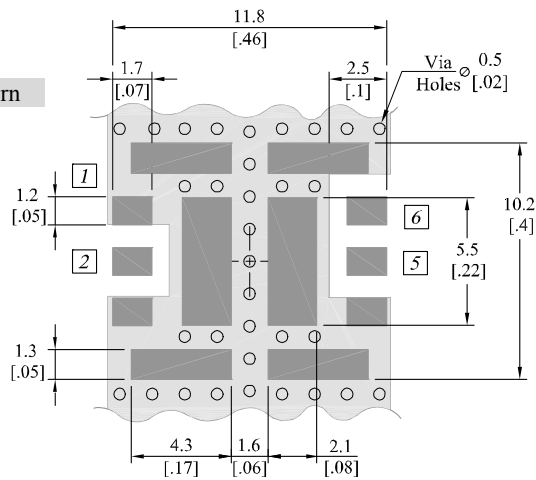

## ESD Protection

Gallium Arsenide Integrated Circuits are sensitive to electrostatic discharge (ESD) and can be damaged by static electricity. Proper ESD control techniques should be used when handling these devices. Some of the precautions recommended are;

- Person at a workbench should be earthed via a wrist strap and a resistor.
- All mains-powered equipment should be connected to the mains via an earth-leakage switch.
- Equipment cases should be grounded.
- Relative humidity should be maintained between 40% and 50%.
- An ionizer is recommended.
- Keep static materials, such as plastic envelopes and plastic trays etc. away from the workbench.

RFHIC Corporation (RFHIC) reserves the right to make changes to any products herein or to discontinue any product at any time without notice. RFHIC do not assume any liability for the suitability of its products for any particular purpose, and disclaims any and all liability, including without limitation consequential or incidental damages. The product specifications herein expressed have been carefully checked and are assumed to be reliable. However, RFHIC disclaims liability for inaccuracies and strongly recommends buyers to verify that the information they are using is current before placing purchase orders. RFHIC products are not intended for use in life support equipment or application where malfunction of the product can be expected to result in personal injury or death. Buyer uses or sells such products for any such unintended or unauthorized application, buyer shall indemnify, protect and hold RFHIC and its directors, officers, stockholders, employees, representatives and distributors harmless against any and all claims arising out of such use. RFHIC's liability under or arising out of damages, claims of whatsoever kind and nature which RFHIC products could cause shall be limited in amount to the net purchase price of the products sold to buyer by RFHIC.