

CDSQR4448-HF (RoHS Device)

High Speed

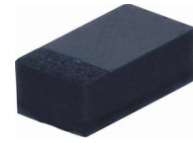

Features

- Halogen free.
- Fast Switching Speed.
- Designed for mounting on small surface.
- Extremely thin/leadless package.

Mechanical data

- Case: 0402(1005) standard package, molded plastic.
- Terminals: Gold plated, solderable per MIL-STD-750, method 2026.
- Marking Code: Cathode band & S5
- Mounting position: Any
- Weight: 0.001 gram (approx.).

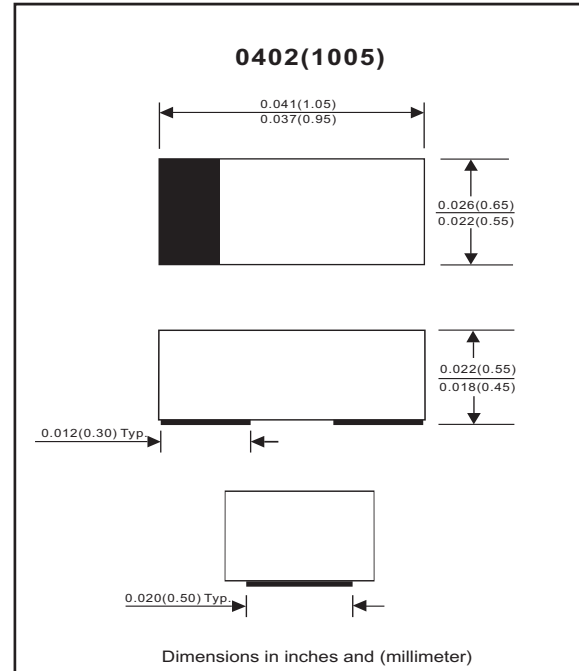

Maximum Rating (at TA=25°C unless otherwise noted)

Parameter	Conditions	Symbol	Min	Typ	Max	Unit
Repetitive peak reverse voltage		V _{RRM}			100	V
Reverse voltage		V _R			80	V
Average forward current		I _o			125	mA
Forward current, surge peak	T _P = 1μS T _P = 8.3mS	I _{FSM}			2 1	A
Power Dissipation		P _D			125	mW
Storage temperature		T _{STG}	-40		+125	°C
Junction temperature		T _j			+125	°C

Electrical Characteristics (at TA=25°C unless otherwise noted)

Parameter	Conditions	Symbol	Min	Typ	Max	Unit
Forward voltage	I _F = 5 mA I _F = 100 mA	V _F	0.62		0.72 1	V
Reverse current	V _R = 20 V V _R = 80 V	I _R			25 100	nA
Capacitance between terminals	f = 1 MHz, and 0.5 VDC reverse voltage	C _T			9	pF
Reverse recovery time	I _F = I _R = 10mA, I _{rr} = 0.1 X I _R , R _L = 100ohm	T _{rr}			9	nS

RATING AND CHARACTERISTIC CURVES (CDSQR4448-HF)

Fig. 1 - Forward characteristics

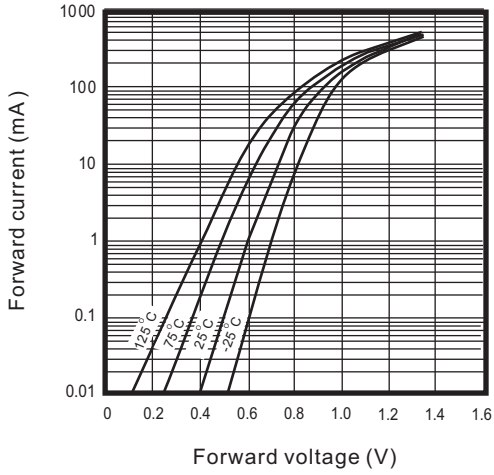

Fig. 2 - Reverse characteristics

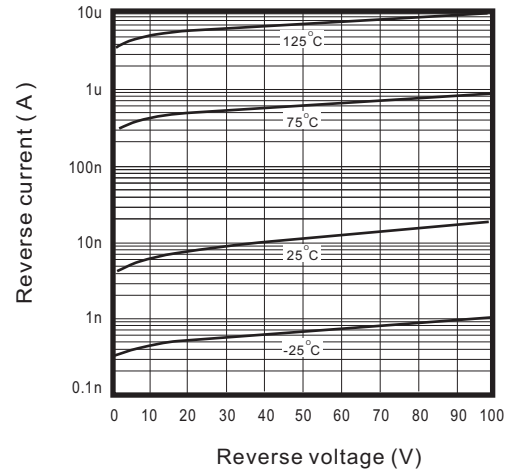

Fig. 3 - Capacitance between terminals characteristics

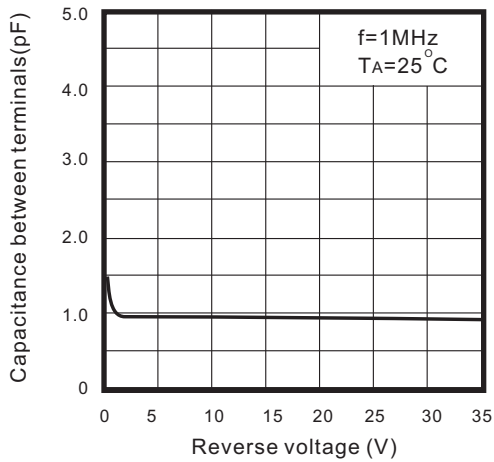
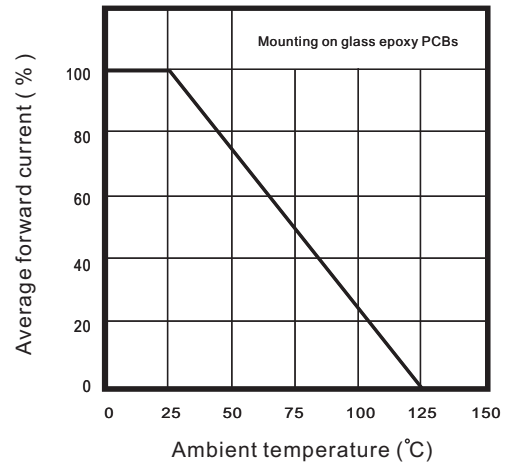
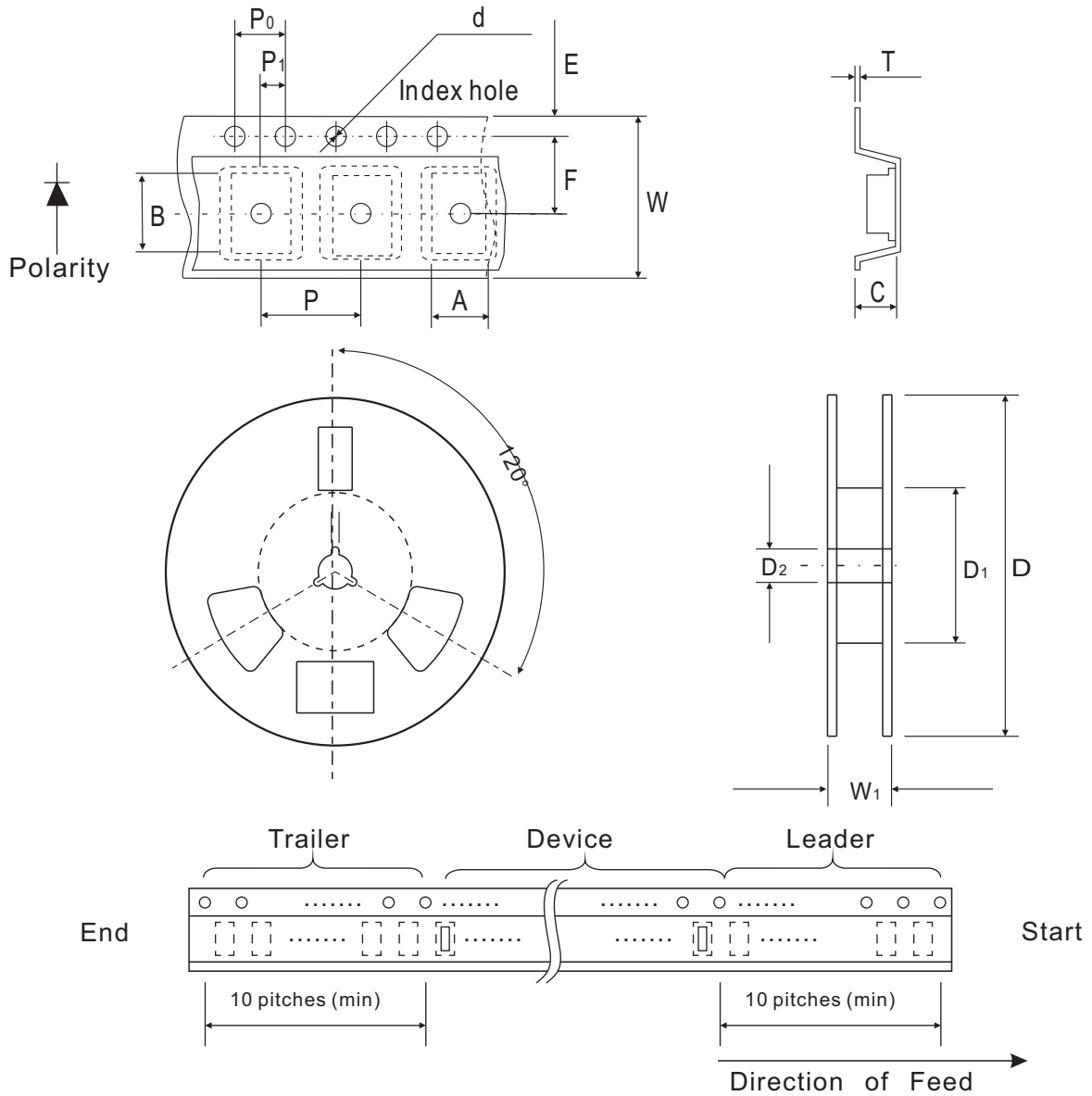

Fig. 4 - Current derating curve



Reel Taping Specification



QR/0402	SYMBOL	A	B	C	d	D	D ₁	D ₂
	(mm)	0.75 ± 0.10	1.15 ± 0.10	0.60 ± 0.10	1.55 ± 0.10	178 ± 1	60.0 MIN.	13.0 ± 0.20
	(inch)	0.026 ± 0.004	0.045 ± 0.004	0.024 ± 0.004	0.061 ± 0.004	7.008 ± 0.04	2.362 MIN.	0.512 ± 0.008

QR/0402	SYMBOL	E	F	P	P ₀	P ₁	T	W	W ₁
	(mm)	1.75 ± 0.10	3.50 ± 0.05	4.00 ± 0.10	4.00 ± 0.10	2.00 ± 0.10	0.22 ± 0.05	8.00 ± 0.20	13.5 MAX.
	(inch)	0.069 ± 0.004	0.138 ± 0.002	0.157 ± 0.004	0.157 ± 0.004	0.079 ± 0.004	0.009 ± 0.002	0.315 ± 0.008	0.531 MAX.

Marking Code

Part Number	Marking Code
CDSQR4448-HF	S5



Suggested PAD Layout

SIZE	QR/0402	
	(mm)	(inch)
A	0.750	0.030
B	0.500	0.020
C	0.700	0.028
D	1.250	0.049
E	0.250	0.010

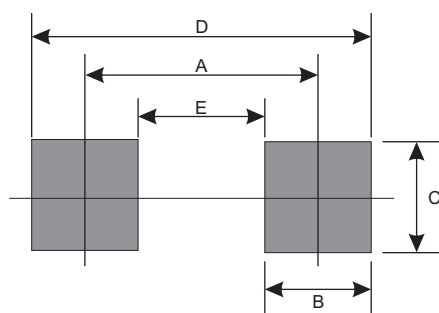

Standard Package

Case Type	Qty per Reel	Reel Size
	(Pcs)	(inch)
QR/0402	5000	7