

LESD7D3.3T5G ESD PROTECTION DIODE

Discription

The LESD7D3.3T5G is designed to protect voltage sensitive components from ESD. Excellent clamping capability, low leakage, and fast response time provide best in class protection on designs that are exposed to ESD. Because of its small size, it is suited for use in cellular phones, MP3 players, digital cameras and many other portable applications where board space is at a premium.

Applications

- | Cellular phones audio
- | MP3 players
- | Digital cameras
- | Portable applications
- | mobile telephone

Features

- | Small Body Outline Dimensions:
0.039" x 0.024" (1.0 mm x 0.60 mm)
- | Low Body Height: 0.017" (0.43 mm) Max
- | Stand-off Voltage: 3.3 V - 12 V
- | Low Leakage
- | Response Time is Typically < 1 ns
- | ESD Rating of Class 3 (> 16 kV) per Human Body Model
- | IEC61000-4-2 Level 4 ESD Protection
- | We declare that the material of product compliance with RoHS requirements.

LESD7D3.3T5G

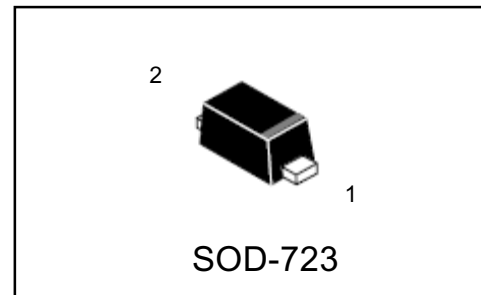

PIN 1. CATHODE
2. ANODE

Ordering information

Device	Package	Shipping
LESD7D3.3T5G	SOD-723	8000/Tape&Reel

MAXIMUM RATINGS

Rating	Symbol	Value	Unit
IEC61000-4-2 (ESD)	air discharge contact discharge	±15 ±8	KV
ESD Voltage	Per Human Body Model	16	kV
Total Power Dissipation on FR-5 Board (Note 1) @ T _A =25°C	PD	150	Mw
Junction and Storage Temperature Range	T _J ,T _{STG}	-55 to 150	°C
Lead Solder Temperature – Maximum (10 Second Duration)	TL	260	°C

Stresses exceeding Maximum Ratings may damage the device. Maximum Rating are stress ratings only. Functional operation above the Recommended Operating Conditions is not implied. Extended exposure to stresses above the Recommended Operating Conditions may affect device reliability.

1. FR-5 = 1.0*0.75*0.62 in.

LESD7D3.3T5G

ELECTRICAL CHARACTERISTICS

($T_A = 25^\circ\text{C}$ unless otherwise noted)

Symbol	Parameter
I_{PP}	Maximum Reverse Peak Pulse Current
V_C	Clamping Voltage @ I_{PP}
V_{RWM}	Working Peak Reverse Voltage
I_R	Maximum Reverse Leakage Current @ V_{RWM}
V_{BR}	Breakdown Voltage @ I_T
I_T	Test Current
I_F	Forward Current
V_F	Forward Voltage @ I_F
P_{pk}	Peak Power Dissipation
C	Max. Capacitance @ $V_R = 0$ and $f = 1$ MHz

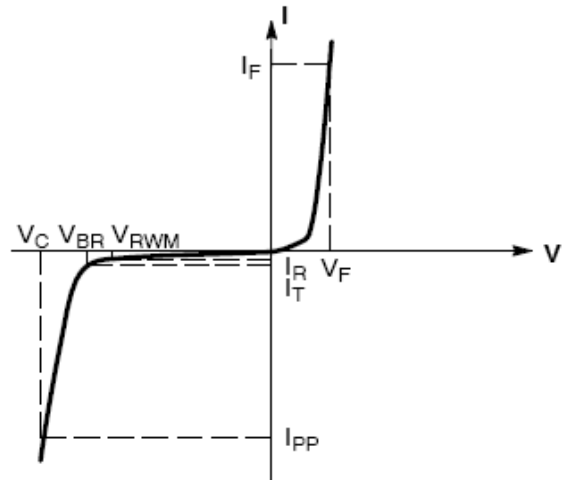

Uni-Directional TVS

ELECTRICAL CHARACTERISTICS ($T_A=25^\circ\text{C}$ unless otherwise noted, $V_F=0.9\text{V}$ Max. @ $I_F=10\text{Ma}$ for all types)

Device	V_{RWM} (V)	I_R (μA) @ V_{RWM}	V_{BR} (V) @ I_T (Note 2)	I_T (mA)	I_{PP} (A) (Note 3)	V_C (V) @ Max I_{PP} (Note 3)	P_{PK} (W) (8*20 μs)	C (pF)
	Max	Max	Min		Max	Max	Typ	Typ
LESD7D3.3T5G	3.3	2.5	5.0	1.0	9.8	10.4	102	80
LESD7D5.0T5G	5.0	1.0	6.2	1.0	8.7	12.3	107	65

Other voltage available upon request.

- V_{BR} is measured with a pulse test current I_T at an ambient temperature of 25°C
- Surge current waveform per Figure 3.

LESD7D3.3T5G

TYPICAL CHARACTERISTICS

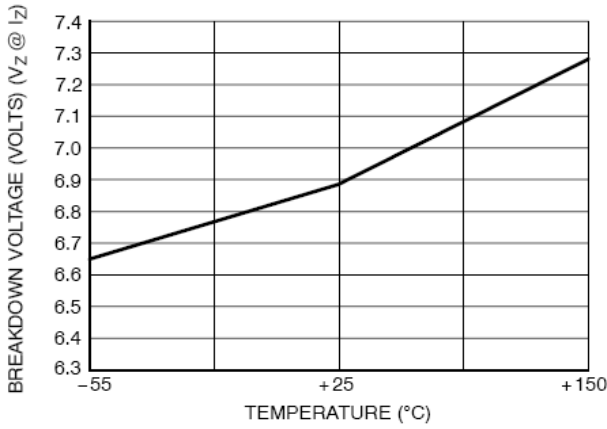

Figure 1. Typical Breakdown Voltage versus Temperature

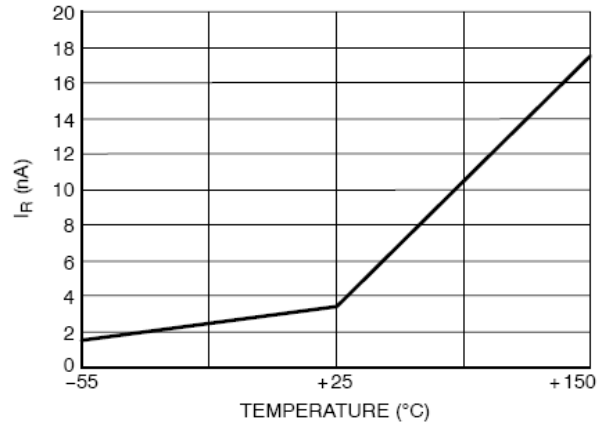

Figure 2. Typical Leakage Current versus Temperature

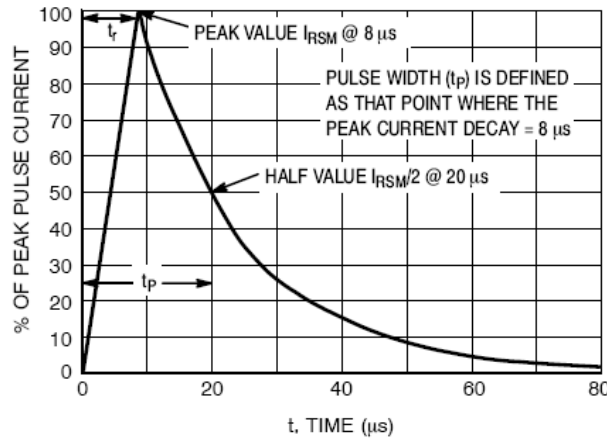

Figure 3. 8*20 μs Pulse Waveform

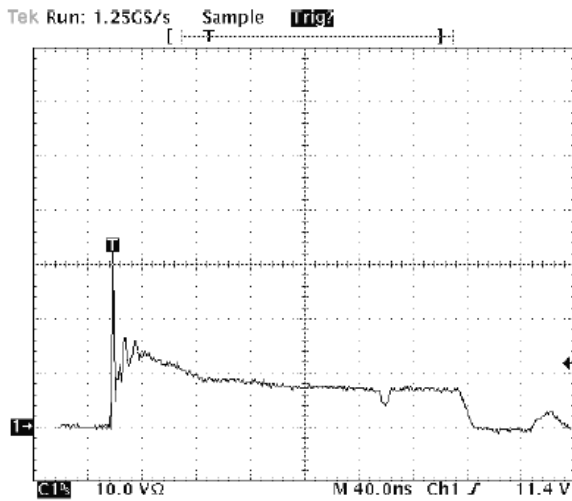

Figure 4. Positive 8kV contact per IEC 61000-4-2-LESD7D5.0T5G

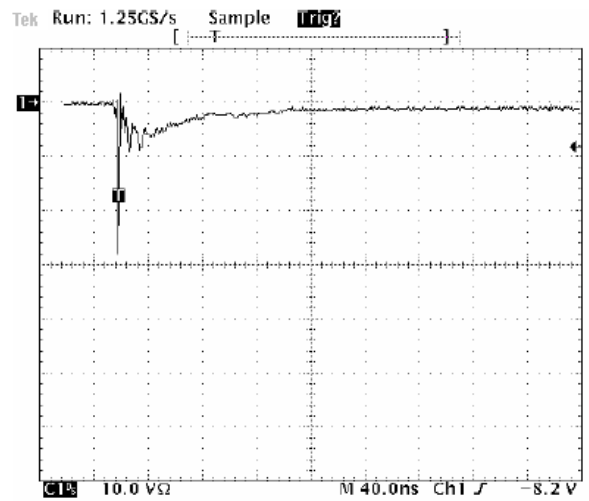
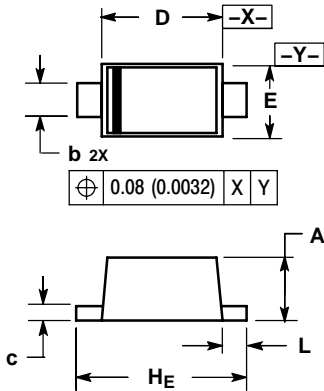

Figure 5. Negative 8kV contact per IEC 61000-4-2-LESD7D5.0T5G

LESD7D3.3T5G

SOD-723



- NOTES:
1. DIMENSIONING AND TOLERANCING PER ANSI Y14.5M, 1982.
 2. CONTROLLING DIMENSION: MILLIMETER.
 3. MAXIMUM LEAD THICKNESS INCLUDES LEAD FINISH THICKNESS. MINIMUM LEAD THICKNESS IS THE MINIMUM THICKNESS OF BASE MATERIAL.

DIM	MILLIMETERS			INCHES		
	MIN	NOM	MAX	MIN	NOM	MAX
A	0.49	0.52	0.55	0.019	0.020	0.022
b	0.25	0.28	0.32	0.0098	0.011	0.013
c	0.08	0.12	0.15	0.0032	0.0047	0.0059
D	0.95	1.00	1.05	0.037	0.039	0.041
E	0.55	0.60	0.65	0.022	0.024	0.026
HE	1.35	1.40	1.45	0.053	0.055	0.057
L	0.15	0.20	0.25	0.006	0.0079	0.010

SOLDERING FOOTPRINT*

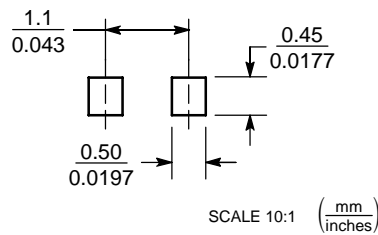

EMBOSSED TAPE AND REEL DATA FOR DISCRETES

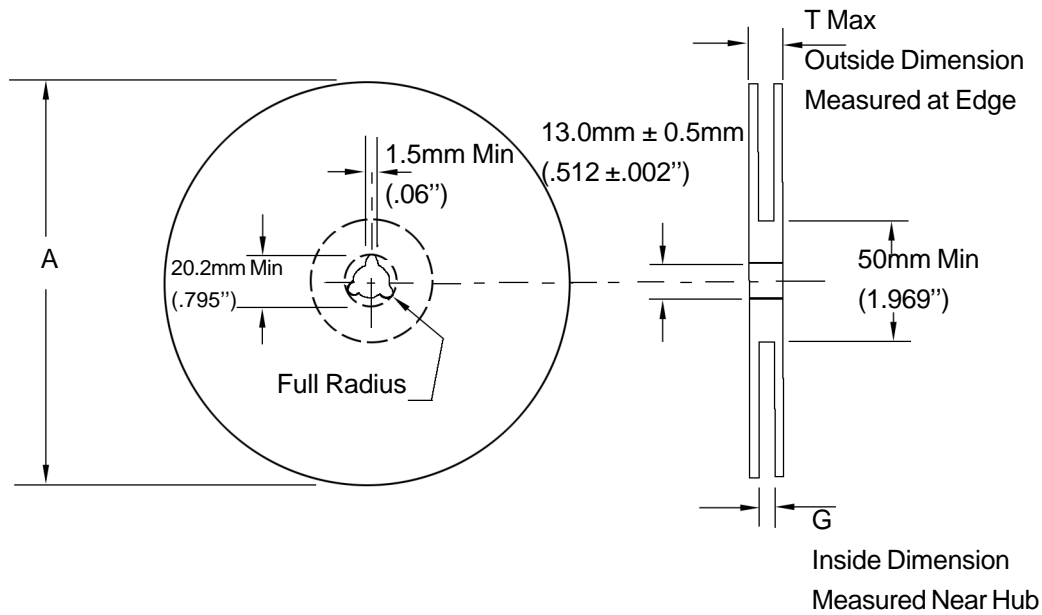

Size	A Max	G	T Max
8 mm	330mm (12.992")	8.4mm+1.5mm, -0.0 (.33"+.059", -0.00)	14.4mm (.56")

Reel Dimensions

Metric Dimensions Govern — English are in parentheses for reference only

Storage Conditions

Temperature: 5 to 40 Deg.C (20 to 30 Deg. C is preferred)
 Humidity: 30 to 80 RH (40 to 60 is preferred)
 Recommended Period: One year after manufacturing
 (This recommended period is for the soldering condition only. The characteristics and reliabilities of the products are not restricted to this limitation)

Shipment Specification

