

**PLEASE CHECK WWW.MOLEX.COM FOR LATEST PART INFORMATION**

**Part Number:** [0430450201](#)  
**Status:** **Active**  
**Overview:** [microfit\\_30](#)  
**Description:** 3.00mm (.118") Pitch Micro-Fit 3.0™ Header, Surface Mount Compatible, Dual Row, Right Angle, with Snap-in Plastic Peg PCB Lock, 2 Circuits, 0.38µm (15µ") Gold (Au) Selective Plating, Glow Wire Compatible

**Documents:**

[3D Model](#) [Product Specification PS-43045 \(PDF\)](#)  
[Drawing \(PDF\)](#) [RoHS Certificate of Compliance \(PDF\)](#)

**Agency Certification**

CSA	LR19980
TUV	R72081037
UL	E29179

**General**

Product Family	PCB Headers
Series	<a href="#">43045</a>
Application	Wire-to-Board
Comments	Glow Wire Equivalent Part Number <a href="#">430450201</a> . High Temperature, Square Pin, Solder Type
Overview	<a href="#">microfit_30</a>
Product Literature Order No	USA-106
Product Name	Micro-Fit 3.0™

**Physical**

Breakaway	No
Circuits (Loaded)	2
Circuits (maximum)	2
Color - Resin	Black
Durability (mating cycles max)	30
Flammability	94V-0
Glow-Wire Compliant	Yes
Mated Height (in)	0.405 In
Mated Height (mm)	10.29 mm
Material - Metal	Brass
Material - Plating Mating	Gold
Material - Plating Termination	Tin
Material - Resin	High Temperature Thermoplastic
Number of Rows	2
Orientation	Right Angle
PCB Locator	Yes
PCB Retention	Yes
PCB Thickness Recommended (in)	0.062 In
PCB Thickness Recommended (mm)	1.60 mm
Packaging Type	Tray
Pitch - Mating Interface (in)	0.118 In
Pitch - Mating Interface (mm)	3.00 mm
Plating min: Mating (µin)	15
Plating min: Mating (µm)	0.375
Plating min: Termination (µin)	100
Plating min: Termination (µm)	2.5
Polarized to PCB	Yes
Shrouded	Fully
Stackable	No

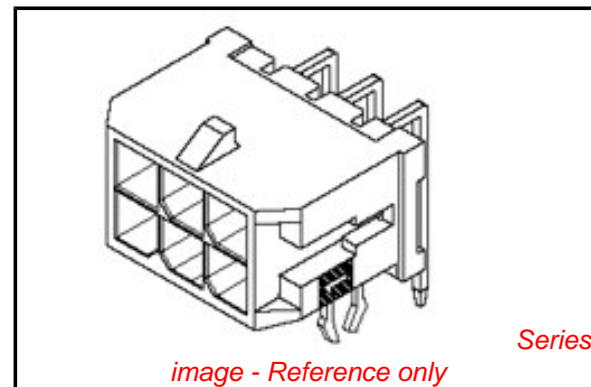

image - Reference only

**EU RoHS**

**ELV and RoHS Compliant**  
**REACH SVHC Contains SVHC: No**  
**Halogen-Free Status**

**China RoHS**



**Need more information on product environmental compliance?**

Email [productcompliance@molex.com](mailto:productcompliance@molex.com)  
 For a multiple part number RoHS Certificate of Compliance, [click here](#)

Please visit the [Contact Us](#) section for any non-product compliance questions.

**Search Parts in this Series**

[43045Series](#)

**Mates With**

[43025](#)

Surface Mount Compatible (SMC)	Yes
Temperature Range - Operating	-40°C to +105°C
Termination Interface: Style	Through Hole

### **Electrical**

Current - Maximum per Contact	5A
Voltage - Maximum	250V

### **Solder Process Data**

Duration at Max. Process Temperature (seconds)	30
Lead-free Process Capability	SMC & Wave Capable (TH only)
Max. Cycles at Max. Process Temperature	3
Process Temperature max. C	260

### **Material Info**

#### **Reference - Drawing Numbers**

Packaging Specification	PK-70873-0313
Product Specification	PS-43045, RPS-43045-003, RPS-43045-004
Sales Drawing	SD-43045-001, SDIN-43045-0001
Test Summary	TS-43045-001, TS-43045-002

This document was generated on 05/24/2010

**PLEASE CHECK [WWW.MOLEX.COM](http://WWW.MOLEX.COM) FOR LATEST PART INFORMATION**

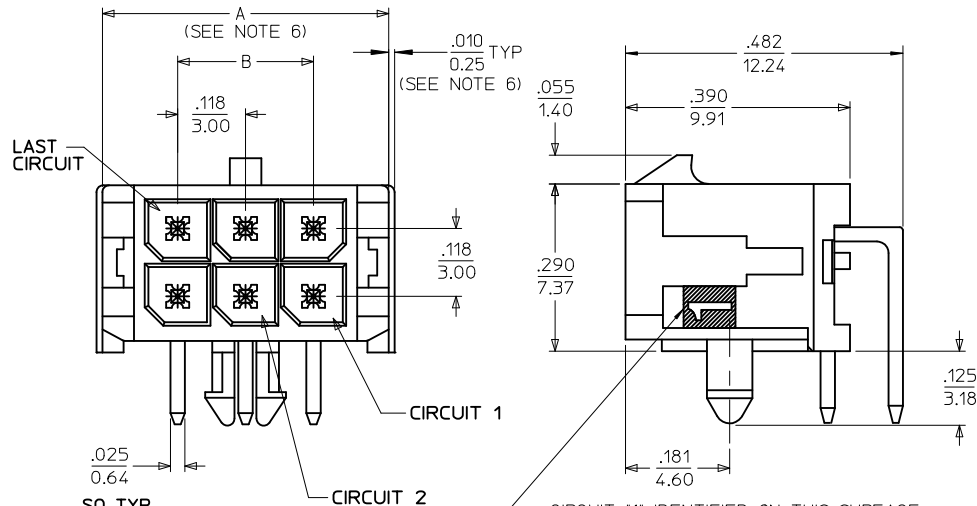
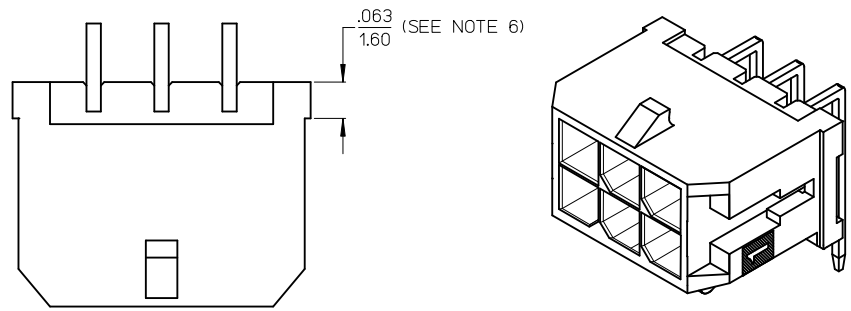

CIRCUIT \*1 IDENTIFIED ON THIS SURFACE (APPROX. LOCATION SHOWN FOR REF.)

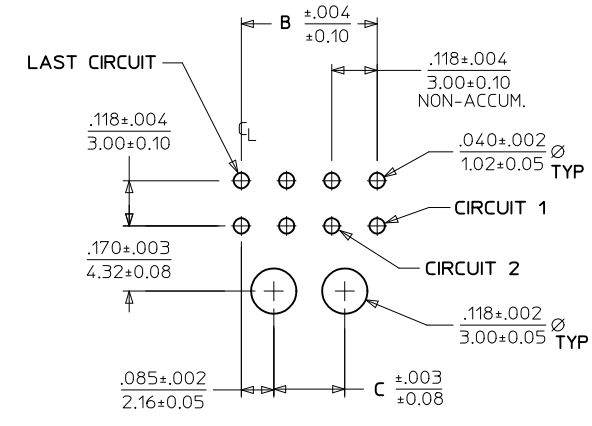

PCB LAYOUT: COMPONENT SIDE  
RECOMMEND PCB THICKNESS: .062/1.57

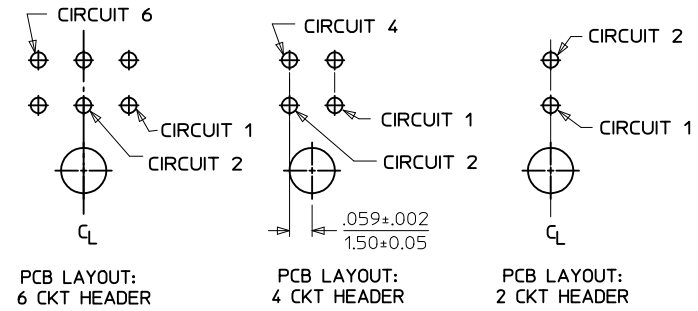

CKTS	A (SEE NOTE 6)		
	B	C	
02	.262 6.65	NA	NA
04	.380 9.65	.118 3.00	NA
06	.498 12.65	.236 6.00	NA
08	.616 15.65	.354 9.00	.185 4.70
10	.734 18.65	.472 12.00	.303 7.70
12	.852 21.65	.591 15.00	.421 10.70
14	.970 24.65	.709 18.00	.539 13.70
16	1.088 27.65	.827 21.00	.657 16.70
18	1.206 30.65	.945 24.00	.776 19.70
20	1.325 33.65	1.063 27.00	.894 22.70
22	1.443 36.65	1.181 30.00	1.012 25.70
24	1.561 39.65	1.299 33.00	1.130 28.70

NOTES:

- HOUSING MATERIAL: GLASS FILLED LIQUID CRYSTAL POLYMER, UL94V-0, COLOR: BLACK  
TERMINAL MATERIAL: BRASS ALLOY
- FINISH: A = .000100/(0.00254) MIN. TIN OVER  
.000050/(0.00127) MIN. NICKEL PLATE.  
B = .000015/(0.00038) MIN. SELECT GOLD IN CONTACT AREA,  
.000100/(0.00254) MIN. SELECT MATTE TIN ON SOLDER TAILS,  
BOTH OVER .000050/(0.00127) MIN. NICKEL PLATE.  
C = .000030/(0.00076) MIN. SELECT GOLD IN CONTACT AREA,  
.000100/(0.00254) MIN. SELECT MATTE TIN ON SOLDER TAILS,  
BOTH OVER .000050/(0.00127) MIN. NICKEL PLATE.  
\* THE PRIMARY SHIPPING CARTON WILL BE LABELED "COMPLIANT TO RoHS DIRECTIVE 2002/95/EC AND ELV ANNEX II OF DIRECTIVE 2000/53/EC." CARTONS WITHOUT THIS LABEL MAY CONTAIN PRODUCT WITH TIN/LEAD IN THE PC TAIL AREA.
- PRODUCT SPECIFICATION: PS-43045
- TRAY PACKAGED : SEE MOLEX DRAWING PK-70873-0313
- MATES WITH MICRO FIT (3.0) RECEPTACLE SERIES 43025
- .010/0.25 OFFSETS ARE PRESENT ON ALL PARTS MANUFACTURED AFTER 11/1/2007, AND ON PARTS PRIOR TO 11/1/2007 THAT CONTAIN A GREEN DOT ON THE PRIMARY SHIPPING CARTON LABEL.
- TO AVOID INTERFERENCE BETWEEN RECEPTACLE AND PCB, HEADER MUST BE PLACED WITHIN .400/(10.16) MAX. FROM EDGE OF PCB, AS SHOWN IN LOCATION DETAIL.
- THIS PART CONFORMS TO CLASS B REQUIREMENTS OF PRODUCT SPECIFICATION PS-45499-002.

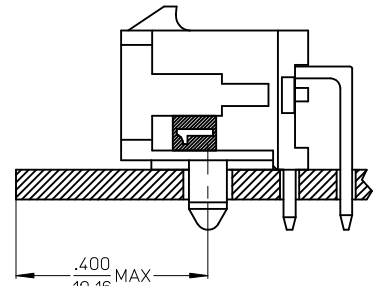

LOCATION DETAIL  
SEE NOTE #7

CKTS	FINISH A	FINISH B	FINISH C
	MATERIAL NO:	MATERIAL NO:	MATERIAL NO:
02	43045-0200	43045-0201	43045-0202
04	43045-0400	43045-0401	43045-0402
06	43045-0600	43045-0601	43045-0602
08	43045-0800	43045-0801	43045-0802
10	43045-1000	43045-1001	43045-1002
12	43045-1200	43045-1201	43045-1202
14	43045-1400	43045-1401	43045-1402
16	43045-1600	43045-1601	43045-1602
18	43045-1800	43045-1801	43045-1802
20	43045-2000	43045-2001	43045-2002
22	43045-2200	43045-2201	43045-2202
24	43045-2400	43045-2401	43045-2402

CORRECTED .482/12.24 EC NO: UCP2010-1324 DRAWN:TBENES 2009/11/25 CHKD:SSOUSEK 2009/11/25 APPR:FSMLTH 2009/11/30	QUALITY SYMBOLS ∇=0 ∇=0 ∇=0	GENERAL TOLERANCES (UNLESS SPECIFIED) mm INCH 4 PLACES ± --- ± --- 3 PLACES ± --- ± .010 2 PLACES ± 0.25 ± .014 1 PLACE ± 0.36 ± --- ANGULAR ± 1/2°	DIMENSION STYLE IN/MM DRAWN BY DATE SAMIEC 2000/03/15 CHECKED BY DATE MUELLER 2000/03/15 APPROVED BY DATE EDGLEY 2000/03/15	SCALE --- DESIGN UNITS METRIC	THIRD ANGLE PROJECTION	
		DRAFT WHERE APPLICABLE MUST REMAIN WITHIN DIMENSIONS	MATERIAL NO. SEE CHART	TITLE MICRO-FIT (3.0) DUAL ROW RIGHT ANGLE THRU HOLE HEADER ASSY	MOLEX INCORPORATED	SHEET NO. 1 OF 1
		THIS DRAWING CONTAINS INFORMATION THAT IS PROPRIETARY TO MOLEX INCORPORATED AND SHOULD NOT BE USED WITHOUT WRITTEN PERMISSION	DOCUMENT NO. SD-43045-001			

20 19 18 17 16 15 14 13 12 11 9 8 7 6 5 4 3 2 1

MICRO-FIT(3.0)  
DUAL-ROW SERIES

MICRO-FIT(3.0)  
IN-LINE SERIES

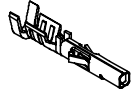

43030-xxxx  
FEMALE CRIMP TERMINAL

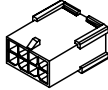

43020-xx01  
PLUG W/O MTG. EARS

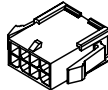

43020-xx00  
PLUG W/ MTG. EARS

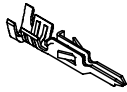

43031-xxxx  
MALE CRIMP TERMINAL

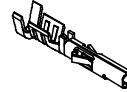

43030-xxxx  
FEMALE CRIMP TERMINAL

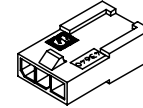

43640-xx01  
PLUG W/O MTG. EARS

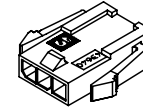

43640-xx00  
PLUG W/ MTG. EARS

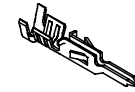

43031-xxxx  
MALE CRIMP TERMINAL

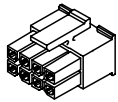

43025-xxxx  
RECEPTACLE

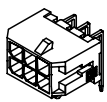

43045-xx00 THRU 43045-xx02  
RIGHT ANGLE THRU HOLE  
W/RETENTION PEG

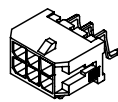

43045-xx03 THRU 43045-xx05  
RIGHT ANGLE SURFACE MOUNT  
W/RETENTION PEG

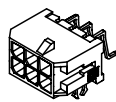

43045-xx06 THRU 43045-xx08  
RIGHT ANGLE SURFACE MOUNT  
W/RETENTION CLIP

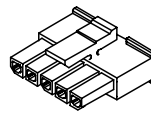

43645-xxxx  
RECEPTACLE

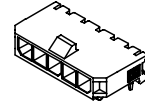

43650-xx00 THRU 43650-xx02  
RIGHT ANGLE THRU HOLE  
W/RETENTION PEG

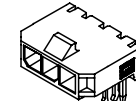

43650-xx03 THRU 43650-xx05  
RIGHT ANGLE THRU HOLE  
W/RETENTION CLIP

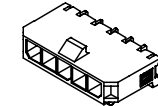

43650-xx06 THRU 43650-xx08  
RIGHT ANGLE SURFACE MOUNT  
W/RETENTION PEG

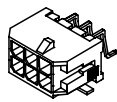

43045-xx09 THRU 43045-xx11  
RIGHT ANGLE SURFACE MOUNT  
W/FITTING NAIL

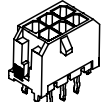

43045-xx12 THRU 43045-xx14  
VERTICAL O.T.R. THRU HOLE

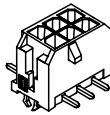

43045-xx15 THRU 43045-xx17  
VERTICAL SURFACE MOUNT  
W/RETENTION CLIP

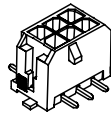

43045-xx18 THRU 43045-xx20  
VERTICAL SURFACE MOUNT  
W/FITTING NAIL

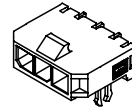

43650-xx09 THRU 43650-xx11  
RIGHT ANGLE SURFACE MOUNT  
W/RETENTION CLIP

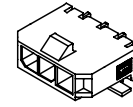

43650-xx12 THRU 43650-xx14  
RIGHT ANGLE SURFACE MOUNT  
W/FITTING NAIL

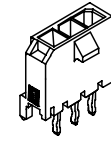

43650-xx15 THRU 43650-xx17  
VERTICAL O.T.R. THRU HOLE

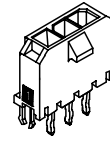

43650-xx18 THRU 43650-xx20  
VERTICAL O.T.R. THRU HOLE  
W/RETENTION CLIP

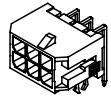

43045-xx21 THRU 43045-xx23  
RIGHT ANGLE THRU HOLE  
W/RETENTION CLIP

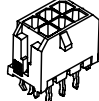

43045-xx24 THRU 43045-xx26  
VERTICAL O.T.R. THRU HOLE  
W/RETENTION CLIP

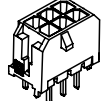

43045-xx27 THRU 43045-xx29  
VERTICAL STRAIGHT PIN THRU HOLE

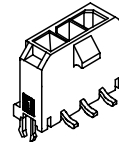

43650-xx21 THRU 43650-xx23  
VERTICAL SURFACE MOUNT  
W/RETENTION CLIP

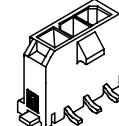

43650-xx24 THRU 43650-xx26  
VERTICAL SURFACE MOUNT  
W/FITTING NAIL

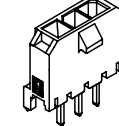

43650-xx27 THRU 43650-xx29  
VERTICAL STRAIGHT PIN THRU HOLE

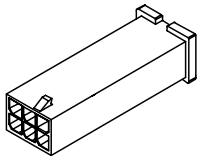

44242-0001 THRU 44242-0011  
4-24 CKT. TEST PLUG

REVISED/REDRAWN EC NO. UCP2004-1223 DRWN: ICERNY 2004/03/12 CHKD: CHKDC 2004/03/31 APPR: FSMITH 2004/04/05	QUALITY SYMBOLS	GENERAL TOLERANCES (UNLESS SPECIFIED)		SCALE	DESIGN UNITS	THIRD ANGLE PROJECTION	REVISE ON CAD ONLY	
	4 PLACES ±.0 3 PLACES ±.0 2 PLACES ±.0 1 PLACE ±.0	mm	INCH	IN/MM	METRIC	DIMENSION STYLE DATE 1999/03/11	TITLE MICRO-FIT (3.0) CONNECTOR FAMILY (INDEX DRAWING)	MATERIAL NO. (DOCUMENT NO.) SEE CHART SDIN-43045-0001
	ANGULAR ±1/2° DRAFT WHERE APPLICABLE MUST REMAIN WITHIN DIMENSIONS				DATE 1999/03/11			
	THIS DRAWING CONTAINS INFORMATION THAT IS PROPRIETARY TO MOLEX INCORPORATED AND SHOULD NOT BE USED WITHOUT WRITTEN PERMISSION							

19 18 17 16 15 14 13 12 11 10 9 8 7 6 5 4 3 2 1