

PROTECTION PRODUCTS - EMIClamp™

Description

The EClamp™1002A is a low pass filter array with integrated TVS diodes for ESD protection. It is designed to provide bidirectional filtering of EMI/RFI signals and electrostatic discharge (ESD) protection in portable electronic equipment. This state-of-the-art device utilizes solid-state silicon-avalanche technology for superior clamping performance and DC electrical characteristics. They have been optimized for use on a speaker port in cellular phones and other portable electronics.

The EClamp1002A effectively replaces 10 discrete components in a small SC-89 package to provide ESD protection and EMI filtering. Each device requires less than 2.9mm² of PCB area with a low profile of only 0.60mm. This small package will protect and filter up to two lines. This small outline makes the device especially well suited for portable applications.

The TVS diodes are bidirectional for supporting bipolar audio signals without distortion. The TVS diodes provide effective suppression of ESD voltages in excess of 15kV (air discharge) and 8kV (contact discharge) per IEC 61000-4-2, level 4. The device has very low insertion loss in the pass band (to approximately 10MHz) and high attenuation at frequencies ranging from 800MHz to 3GHz. Each line features two stages of TVS diode protection. They feature large cross-sectional area junctions for conducting high transient currents. They offer desirable characteristics for board level protection including fast response time, low operating and clamping voltage, and no device degradation.

Dimensions

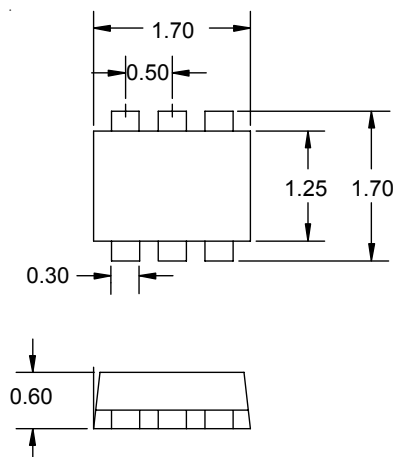

Features

- ◆ Transient protection for data lines to **IEC 61000-4-2 (ESD) 15kV (air), 8kV (contact) IEC 61000-4-4 (EFT) 40A (5/50ns)**
- ◆ Bidirectional EMI/RFI filter with integrated ESD protection
- ◆ Protects two I/O lines
- ◆ Ultra-small SC-89 package (**1.7 x 1.7 x 0.6mm**) requires less than 2.9mm² of PCB area
- ◆ Working voltage: 5V
- ◆ Low leakage current
- ◆ Low operating and clamping voltages
- ◆ Solid-state silicon-avalanche technology

Mechanical Characteristics

- ◆ SC-89 (SOT-666) package
- ◆ RoHS/WEEE Compliant
- ◆ Lead Finish: Matte Tin
- ◆ Molding compound flammability rating: UL 94V-0
- ◆ Marking : Marking Code
- ◆ Weight: 2.9mg (typical)
- ◆ Packaging : Tape and Reel per EIA 481

Applications

- ◆ Cellular Handsets & Accessories
- ◆ Cordless Phones
- ◆ Personal Digital Assistants (PDAs)
- ◆ Webpads & Handhelds
- ◆ Notebook
- ◆ Portable Instrumentation
- ◆ MP3 Players

Schematic & Pin Configuration

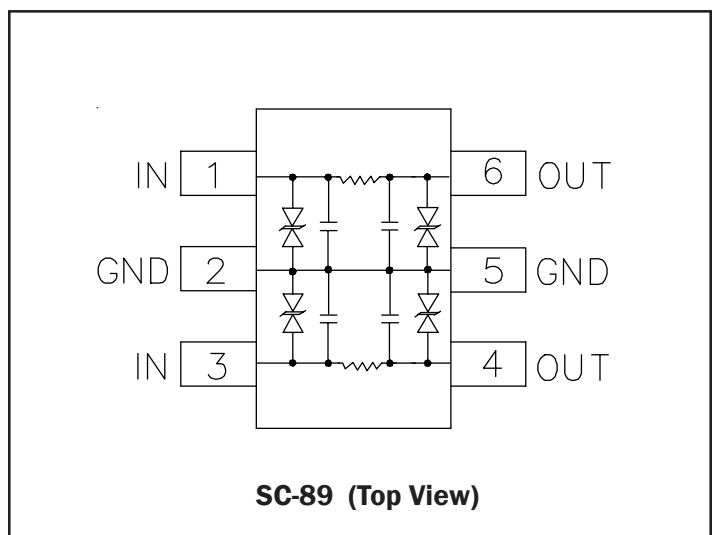

PROTECTION PRODUCTS

Absolute Maximum Rating

Rating	Symbol	Value	Units
Steady-State Power	P_{ss}	100	mW
ESD per IEC 61000-4-2 (Air) ESD per IEC 61000-4-2 (Contact)	V_{ESD}	>16 >10	kV
Operating Temperature	T_J	-55 to +125	°C
Storage Temperature	T_{STG}	-55 to +150	°C

Electrical Characteristics (T=25°C)

Parameter	Symbol	Conditions	Minimum	Typical	Maximum	Units
TVS Reverse Stand-Off Voltage	V_{RWM}				5	V
TVS Reverse Breakdown Voltage	V_{BR}	$I_t = 1mA$	6			V
TVS Reverse Leakage Current	I_R	$V_{RWM} = 5V, T=25^\circ C$			5	μA
Series Resistance	R	Each Line	8.5	10	11.5	Ohms
Total Capacitance	C_{TOT}	Any I/O to Ground $V_R = 0V, f = 1MHz$			160	pF

PROTECTION PRODUCTS

Typical Characteristics

Typical Insertion loss

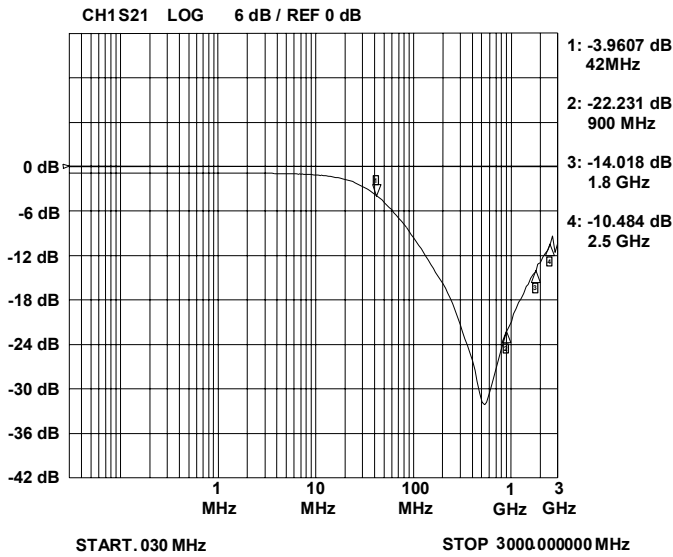

Analog Crosstalk

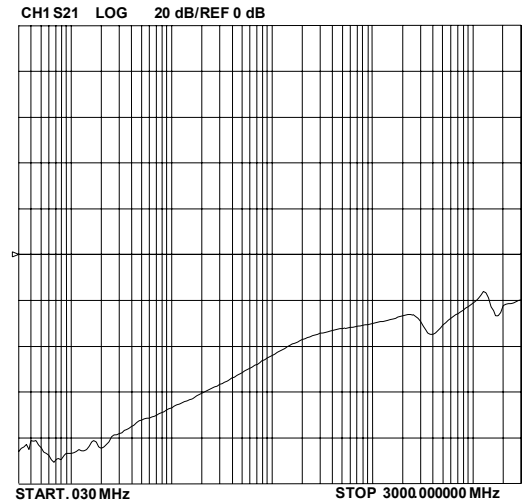

Clamping Voltage vs. Peak Pulse Current

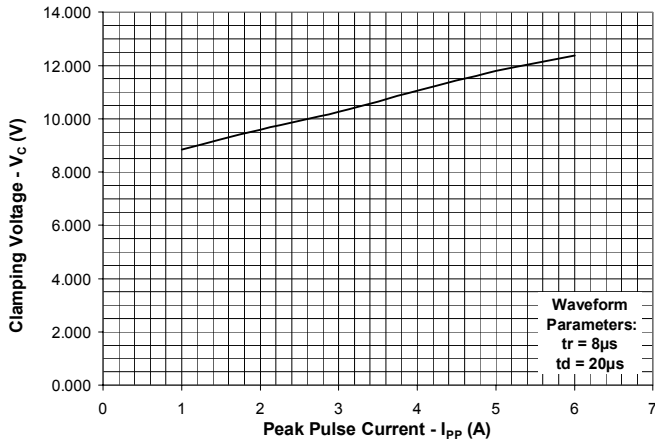

Capacitance vs. Reverse Voltage (Normalized to 0 volts)

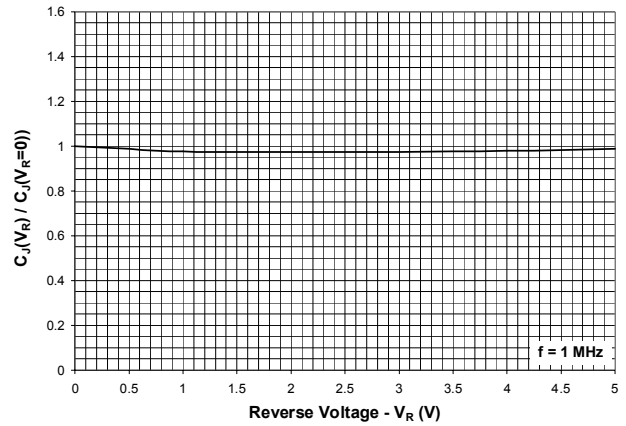

ESD Clamping (8kV Contact)

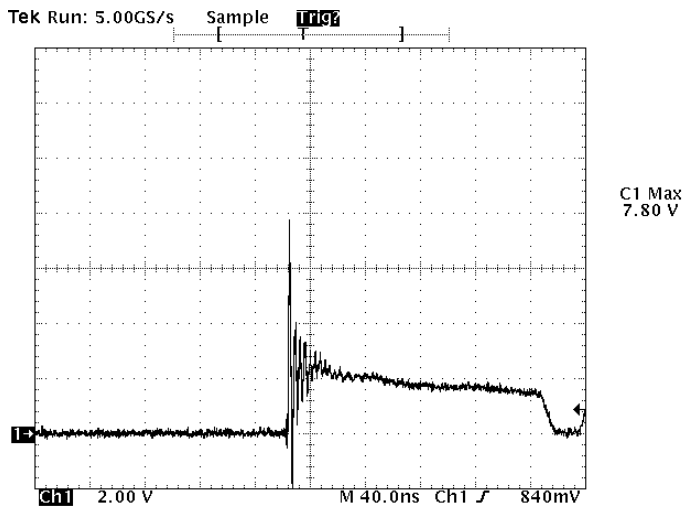

ESD Clamping (15kV Air)

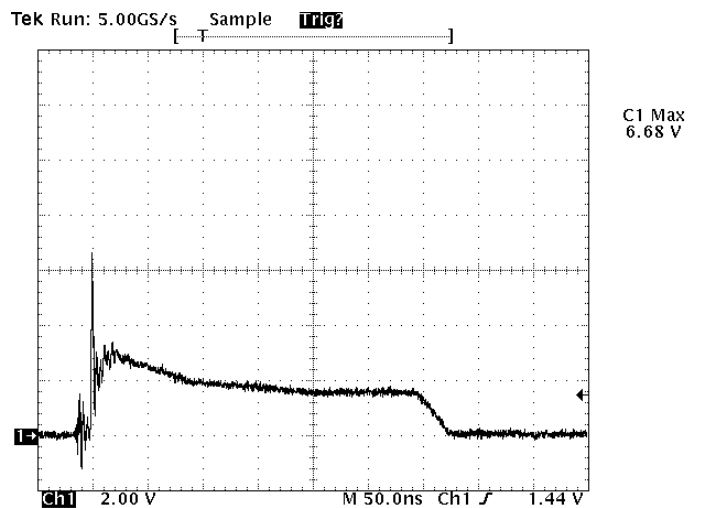

PROTECTION PRODUCTS

Applications Information

Device Connection Options

The EClamp1002A provides EMI filtering and ESD protection in a small SC-89 package for speaker port applications. The equivalent circuit diagram is shown below. The layout of the device is designed such that the data lines can be routed through the device. The first line pair enters at pins 1 and exits at pins 6. The second line pair enters at pins 3 and exits at pins 4. The device is symmetrical so the above connections may be reversed. Layout examples are shown to the right.

Circuit Board Layout Recommendations for Suppression of ESD.

Good circuit board layout is critical for the suppression of ESD induced transients. The following guidelines are recommended:

- Place the TVS near the input terminals or connectors to restrict transient coupling.
- Minimize the path length between the TVS and the protected line.
- Minimize all conductive loops including power and ground loops.
- The ESD transient return path to ground should be kept as short as possible.
- Never run critical signals near board edges.
- Use ground planes whenever possible.

Matte Tin Lead Finish

Matte tin has become the industry standard lead-free replacement for SnPb lead finishes. A matte tin finish is composed of 100% tin solder with large grains. Since the solder volume on the leads is small compared to the solder paste volume that is placed on the land pattern of the PCB, the reflow profile will be determined by the requirements of the solder paste. Therefore, these devices are compatible with both lead-free and SnPb assembly techniques. In addition, unlike other lead-free compositions, matte tin does not have any added alloys that can cause degradation of the solder joint.

Layout Examples

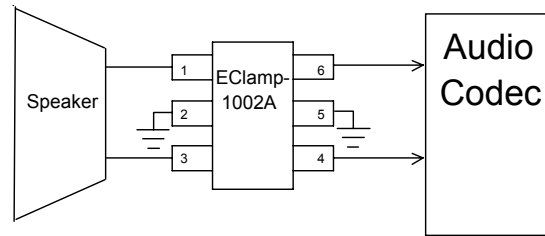

Option 1

Pin	Identification
1	Line 1 In (From Speaker)
6	Line 1 Out (To Audio Circuit)
3	Line 2 In (From Speaker)
4	Line 2 Out (To Audio Circuit)
2, 5	Ground

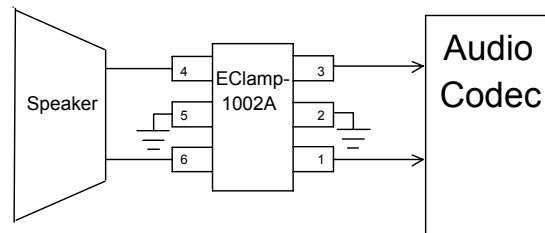

Option 2

Pin	Identification
6	Line 1 In (From Speaker)
1	Line 1 Out (To Audio Circuit)
4	Line 2 In (From Speaker)
3	Line 2 Out (To Audio Circuit)
2, 5	Ground

PROTECTION PRODUCTS

Outline Drawing- SC-89 (SOT-666)

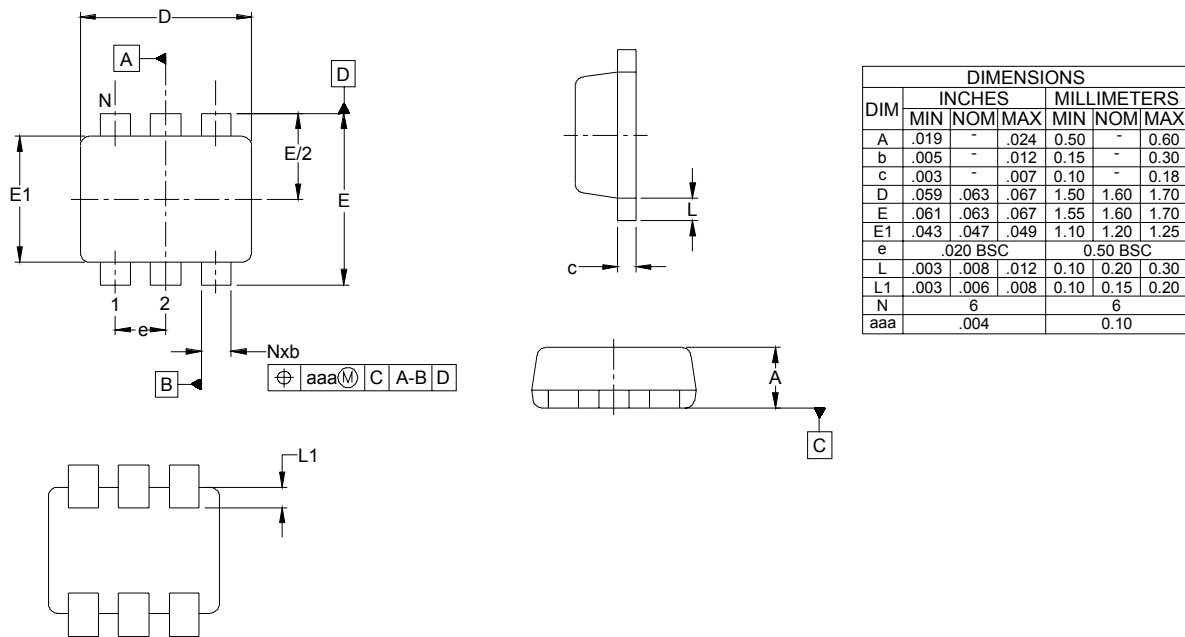

NOTES:

1. CONTROLLING DIMENSIONS ARE IN MILLIMETERS (ANGLES IN DEGREES).
2. DIMENSIONS "E1" AND "D" DO NOT INCLUDE MOLD FLASH, PROTRUSIONS OR GATE BURRS.

Land Pattern- SC-89 (SOT-666)

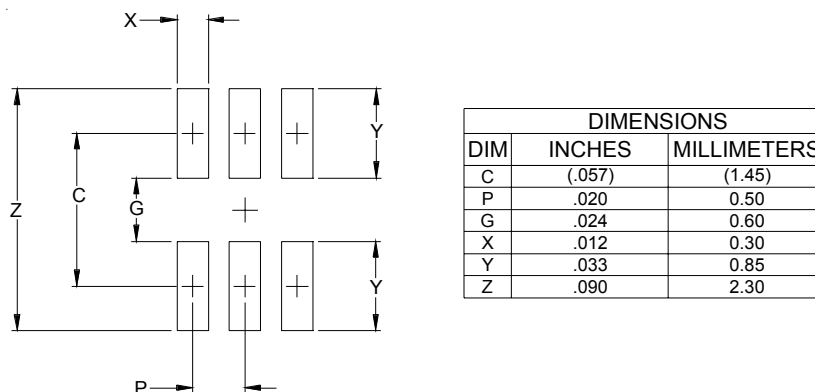

NOTES:

1. THIS LAND PATTERN IS FOR REFERENCE PURPOSES ONLY
CONSULT YOUR MANUFACTURING GROUP TO ENSURE YOUR
COMPANY'S MANUFACTURING GUIDELINES ARE MET

PROTECTION PRODUCTS

Marking Code

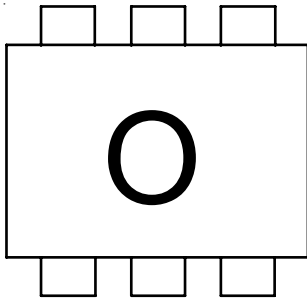

Ordering Information

Part Number	Lead Finish	Device Marking	Qty per Reel	Reel Size
EClamp1002A.TCT	Pb Free	O	3,000	7 Inch

EClamp and EMIClamp are trademarks of Semtech Corporation

Note:

(1) Device is symmetrical so there is no pin 1 identifier.

Tape and Reel Specification

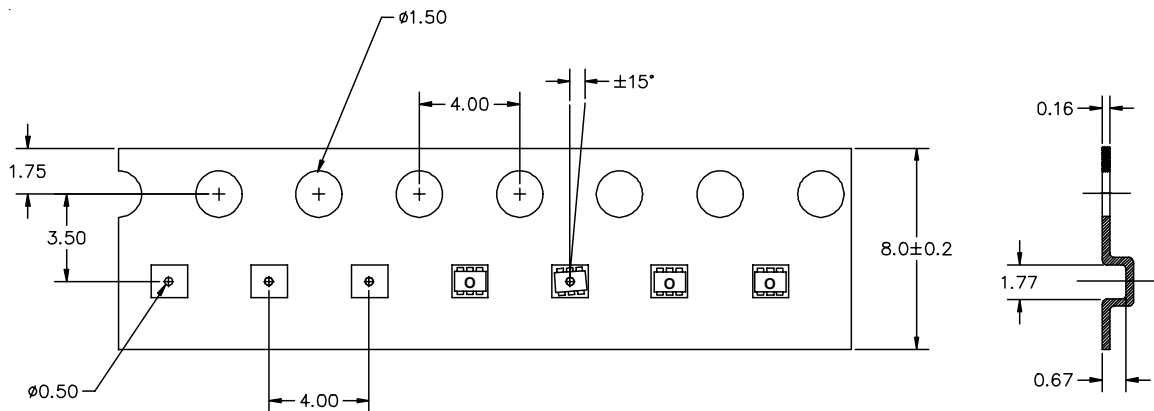

② DIMENSIONS ARE IN MILLIMETERS.

① SAME AS 3M US046041.

Tape Specification and Device Orientation

Contact Information

Semtech Corporation
 Protection Products Division
 200 Flynn Rd., Camarillo, CA 93012
 Phone: (805)498-2111 FAX (805)498-3804