

PLEASE CHECK WWW.MOLEX.COM FOR LATEST PART INFORMATION

Part Number: [0310681011](#)
Status: **Active**
Overview: H-DAC™ 64 Single Row
Description: 2.54mm (.100") H-DAC 64™, 4 Way Receptacle Assembly, Single-Row, Polarization B

Documents:

[Drawing \(PDF\)](#) [Product Specification PS-31100-0001 \(PDF\)](#)
[Application Specification \(PDF\)](#) [RoHS Certificate of Compliance \(PDF\)](#)
[Product Specification PS-31067-0001 \(PDF\)](#)

General

Product Family Crimp Housings
Series 31068
Comments Polarization Option B, Gray
Overview H-DAC™ 64 Single Row
Product Name H-DAC 64™

Physical

Circuits (maximum) 4
Circuits Detail 4
Color - Resin Gray, White
Gender Female
Glow-Wire Compliant No
Keying to Mating Part None
Lock to Mating Part Yes
Material - Resin Modified Polystyrene, Polyester
Number of Rows 1
Packaging Type Bag
Panel Mount No
Pitch - Mating Interface (in) 0.100 In
Pitch - Mating Interface (mm) 2.54 mm
Pitch - Term. Interface (in) 0.100 In
Pitch - Term. Interface (mm) 2.54 mm
Polarized to Mating Part Yes
Ports 1
Stackable No
Temperature Range - Operating -40°C to +100°C

Electrical

Current - Maximum per Contact 11A, 9A

Material Info

Reference - Drawing Numbers

Product Specification PS-31067-0001, PS-31100-0001
Sales Drawing SD-31109-003



image - Reference only

EU RoHS

**ELV and RoHS
Compliant
REACH SVHC
Contains SVHC: No
Halogen-Free
Status**

China RoHS



**Need more information on product
environmental compliance?**

Email productcompliance@molex.com
For a multiple part number RoHS Certificate of Compliance, [click here](#)

Please visit the [Contact Us](#) section for any non-product compliance questions.

Search Parts in this Series

31068Series

Mates With

H-DAC 64™, 4 Way Male Housing Assembly [310681041](#) , [310681071](#) , [311000041](#) , [311010041](#)

Use With

See Product Spec

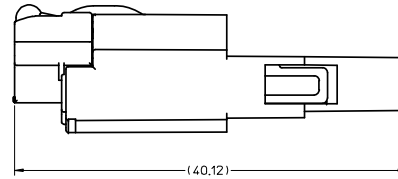
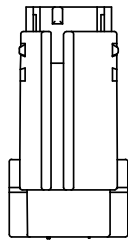

OVERALL MATED LENGTH

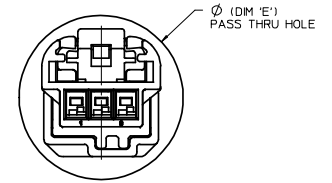

MALE AND FEMALE ASSEMBLY
PASS THRU VIEW
(CAD GENERATED)

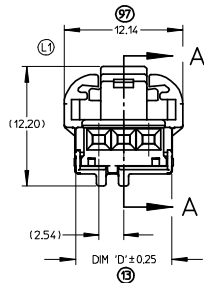
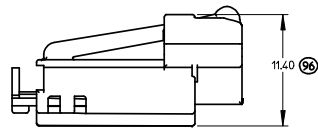

MATING SIDE

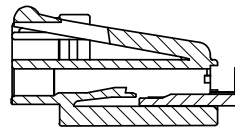

SECTION A-A
SCALE 4:1

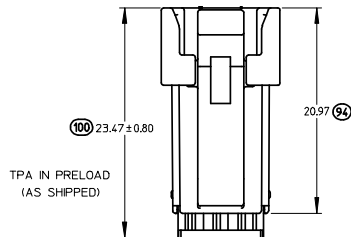

TPA IN PRELOAD
(AS SHIPPED)

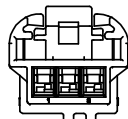

WIRE SIDE

- NOTES:
1. MATERIAL: HOUSING: SPS GLASS FILLED, COLOR SEE CHART.
TPA: PBT
 2. PRODUCT SPECIFICATIONS - IN-LINE MATING INTERFACE: PS-31067-0001.
- DIRECT CONNECT MATING INTERFACE: PS-31100-0001
 3. PACKAGING SPECIFICATION: DRAWING PK-30907-737.
 4. MATES WITH: SEE SALES DRAWINGS SD-31100-003 (MALE IN-LINE),
SD-31197-003 (RIGHT ANGLE HEADER), SD-31101-114 (VERTICAL
"WINGED" HEADER), AND SD-31206-003 (VERTICAL HEADER).
 5. TERMINAL PLATING: TIN (Sn) OVERALL, BRITE FINISH.
THICKNESS = 15 MICROMETER MINIMUM,
NICKEL (Ni) UNDERPLATE OVERALL.
 6. PACKAGING: PLEASE REFERENCE MOLEX SPECIFICATION PS-34646-001,
AVAILABLE AT WWW.MOLEX.COM. (REFERENCE: TPAs THAT ARE FOUND IN
SEATED (FINAL LOCK) POSITION)
 7. APPLICATION SPECIFICATION: AS-31067-100.

ENTER DESCRIPTION IEC NO. UAU2008-0767 DRAWN: MACHUGA 2008/07/08 CHECKED: CHYKOBLOCK 2008/07/09 APPR: SMARCEAU 2008/07/09	QUALITY SYMBOLS ▽=0 ▽=0	GENERAL TOLERANCES (UNLESS SPECIFIED)		DIMENSION STYLE MM ONLY	SCALE 1:1	DESIGN UNITS METRIC	THIRD ANGLE PROJECTION		
		4 PLACES ± --- ± ---	3 PLACES ± --- ± ---	2 PLACES ± 0.13 ± ---	1 PLACE ± 0.25 ± ---	DRAWN BY BDLCK01	DATE 6/22/2007	TITLE FEMALE ASSEMBLY CHARTED SALES DRAWING	
		ANGULAR ±1/2°				CHECKED BY CDILLON	DATE 6/22/2007	MOLEX INCORPORATED	
		DRAFT WHERE APPLICABLE MUST REMAIN WITHIN DIMENSIONS				MATERIAL NO. SEE CHART	APPROVED BY DATE	DOCUMENT NO. SD-31109-003	SHEET NO. 1 OF 4

FEMALE VIEWED FROM MATING SIDE

3 WAY POLARIZATION 'A'

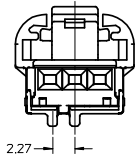

3 WAY POLARIZATION 'B'

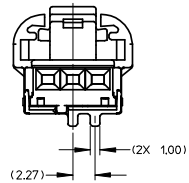

3 WAY POLARIZATION 'C'

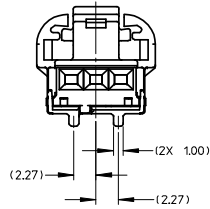

4 WAY POLARIZATION 'A'

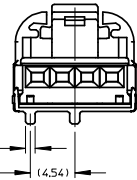

4 WAY POLARIZATION 'B'

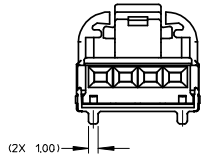

4 WAY POLARIZATION 'C'

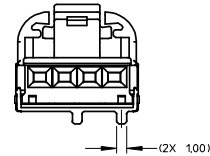

5 WAY POLARIZATION 'A'

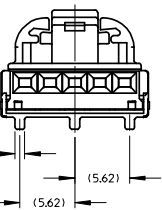

5 WAY POLARIZATION 'B'

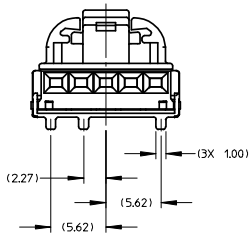

5 WAY POLARIZATION 'C'

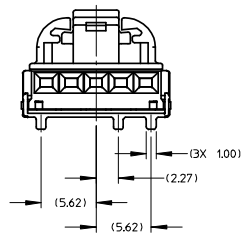

6 WAY POLARIZATION 'A'

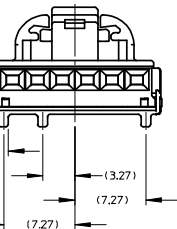

6 WAY POLARIZATION 'B'

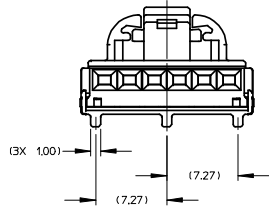

6 WAY POLARIZATION 'C'

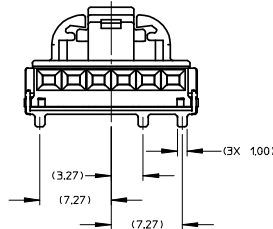

ASSEMBLY PART NUMBER	DESCRIPTION	PART NUMBER	DESCRIPTION	COLOR	DIM 'D'	DIM 'E'	MATING ASSEMBLIES PART NUMBERS				
							INLINE MALE ASSEMBLY W/O XMAS SLOT	INLINE MALE ASSEMBLY W/ XMAS SLOT	RIGHT ANGLE MALE HEADER ASSEMBLY	VERTICAL MALE HEADER ASSEMBLY	VERTICAL MALE WINGED HEADER ASSY
31067-1010	3 WAY FEMALE ASSEMBLY POLARIZATION 'A'	31111-0030	FEMALE HOUSING	BLACK	9.80	16.76	31067-1040	31067-1070	31100-0030 NOT TOOLED	31101-0030 NOT TOOLED	TBD
		31113-0030	TPA	NATURAL (WHITE)							
31067-1011	3 WAY FEMALE ASSEMBLY POLARIZATION 'B'	31111-0031	FEMALE HOUSING	GRAY	9.80	16.76	31067-1041	31067-1071	31100-0031 NOT TOOLED	31101-0031 NOT TOOLED	TBD
		31113-0030	TPA	NATURAL (WHITE)							
31067-1012	3 WAY FEMALE ASSEMBLY POLARIZATION 'C'	31111-0032	FEMALE HOUSING	BROWN	9.80	16.76	31067-1042	31067-1072	31100-0032 NOT TOOLED	31101-0032 NOT TOOLED	TBD
		31113-0030	TPA	NATURAL (WHITE)							
31068-1010	4 WAY FEMALE ASSEMBLY POLARIZATION 'A'	31157-0040	FEMALE HOUSING	BLACK	12.34	18.25	31068-1040	31068-1070	31100-0040	31101-0040	31101-1140
		31158-0040	TPA	NATURAL (WHITE)							
31068-1011	4 WAY FEMALE ASSEMBLY POLARIZATION 'B'	31157-0041	FEMALE HOUSING	GRAY	12.34	18.25	31068-1041	31068-1071	31100-0041	31101-0041	31101-1240
		31158-0040	TPA	NATURAL (WHITE)							
31068-1012	4 WAY FEMALE ASSEMBLY POLARIZATION 'C'	31157-0042	FEMALE HOUSING	BROWN	12.34	18.25	31068-1042	31068-1072	31100-0042	31101-0042	31101-1340
		31158-0040	TPA	NATURAL (WHITE)							
31072-1010	5 WAY FEMALE ASSEMBLY POLARIZATION 'A'	31160-0050	FEMALE HOUSING	BLACK	14.88	20.25	31072-1040	31072-1070	31100-0050 NOT TOOLED	31101-0050 NOT TOOLED	TBD
		31161-0050	TPA	NATURAL (WHITE)							
31072-1011	5 WAY FEMALE ASSEMBLY POLARIZATION 'B'	31160-0051	FEMALE HOUSING	GRAY	14.88	20.25	31072-1041	31072-1071	31100-0051 NOT TOOLED	31101-0051 NOT TOOLED	TBD
		31161-0050	TPA	NATURAL (WHITE)							
31072-1012	5 WAY FEMALE ASSEMBLY POLARIZATION 'C'	31160-0052	FEMALE HOUSING	BROWN	14.88	20.25	31072-1042	31072-1072	31100-0052 NOT TOOLED	31101-0052 NOT TOOLED	TBD
		31161-0050	TPA	NATURAL (WHITE)							
31073-1010	6 WAY FEMALE ASSEMBLY POLARIZATION 'A'	31163-0060	FEMALE HOUSING	BLACK	17.42	22.75	31073-1040	31073-1070	31100-0060 NOT TOOLED	31101-0060 NOT TOOLED	TBD
		31164-0060	TPA	NATURAL (WHITE)							
31073-1011	6 WAY FEMALE ASSEMBLY POLARIZATION 'B'	31163-0061	FEMALE HOUSING	GRAY	17.42	22.75	31073-1041	31073-1071	31100-0061 NOT TOOLED	31101-0061 NOT TOOLED	TBD
		31164-0060	TPA	NATURAL (WHITE)							
31073-1012	6 WAY FEMALE ASSEMBLY POLARIZATION 'C'	31163-0062	FEMALE HOUSING	BROWN	17.42	22.75	31073-1042	31073-1072	31100-0062 NOT TOOLED	31101-0062 NOT TOOLED	TBD
		31164-0060	TPA	NATURAL (WHITE)							

ENTER DESCRIPTION IEC NO. UAU2008-0767 DRAWN/TMACHUGA 2008/07/08 CHYK/BDLCK 2008/07/09 APPR./SMARCEAU 2008/07/09	QUALITY SYMBOLS ▽=0 ▽=0	GENERAL TOLERANCES (UNLESS SPECIFIED)		DIMENSION STYLE MM ONLY	SCALE 1:1	DESIGN UNITS METRIC	THIRD ANGLE PROJECTION
		4 PLACES ± mm INCH 3 PLACES ± --- ± --- 2 PLACES ± 0.13 ± --- 1 PLACE ± 0.25 ± ---	DRAWN BY DATE BDLCK01 6/22/2007		TITLE FEMALE ASSEMBLY CHARTED SALES DRAWING		
		DRAFT WHERE APPLICABLE MUST REMAIN WITHIN DIMENSIONS		MATERIAL NO. DATE SEE CHART		DOCUMENT NO. SHEET NO. SD-31109-003 2 OF 4	
		THIS DRAWING CONTAINS INFORMATION THAT IS PROPRIETARY TO MOLEX INCORPORATED AND SHOULD NOT BE USED WITHOUT WRITTEN PERMISSION					

REFERENCE ONLY

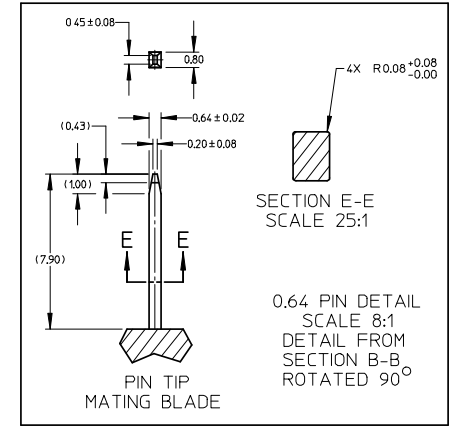
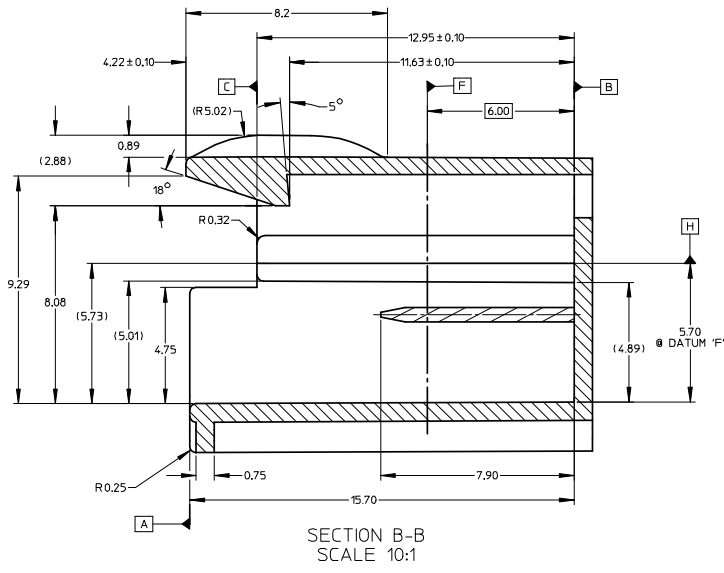
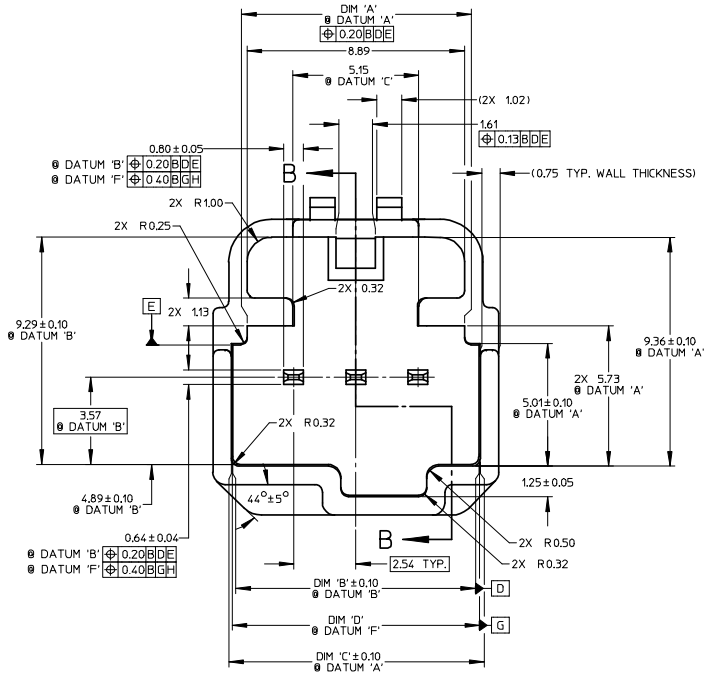

RECOMMENDED DIRECT CONNECT INFO FOR MATING FEMALE PARTS ONLY

DIMENSIONS FOR DIRECT CONNECT

CIRCUIT SIZE	DIM 'A'	DIM 'B'	DIM 'C'	DIM 'D'
3	8.89	10.05	10.19	10.11
4	11.20	12.59	12.73	12.65
5	13.74	15.13	15.27	15.19
6	16.28	17.67	17.81	17.73

ENTER DESCRIPTION IEC NO. UAU2008-0767 DRAWN BY TACHUGA 2008/07/08 CHYK/BDOCK 2008/07/09 APPR: SHARCEAU 2008/07/09	QUALITY SYMBOLS	GENERAL TOLERANCES (UNLESS SPECIFIED)		DIMENSION STYLE MM ONLY	SCALE 1:1	DESIGN UNITS METRIC	THIRD ANGLE PROJECTION
	▼=0 ▽=0	4 PLACES ± mm ± INCH 3 PLACES ± --- ± --- 2 PLACES ± 0.13 ± --- 1 PLACE ± 0.25 ± --- ANGULAR ± 1/2°	DRAFT WHERE APPLICABLE MUST REMAIN WITHIN DIMENSIONS	DRAWN BY DATE BDLCK01' 6/22/2007 CHECKED BY DATE CDILLON 6/22/2007 APPROVED BY DATE	TITLE FEMALE ASSEMBLY CHARTED SALES DRAWING MATERIAL NO. SEE CHART DOCUMENT NO. SD-31109-003 SHEET NO. 3 OF 4		
THIS DRAWING CONTAINS INFORMATION THAT IS PROPRIETARY TO MOLEX INCORPORATED AND SHOULD NOT BE USED WITHOUT WRITTEN PERMISSION							

REFERENCE ONLY

3 WAY POLARIZATION "A"

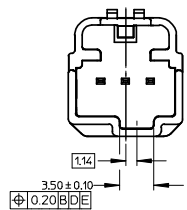

3 WAY POLARIZATION "B"

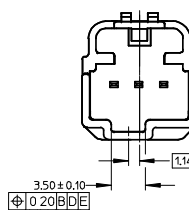

3 WAY POLARIZATION "C"

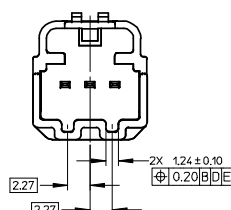

4 WAY POLARIZATION "A"

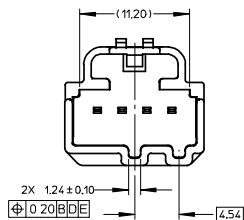

4 WAY POLARIZATION "B"

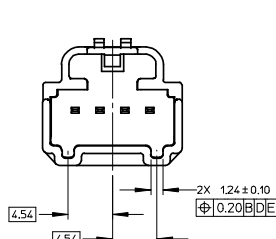

4 WAY POLARIZATION "C"

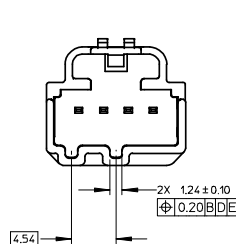

5 WAY POLARIZATION "A"

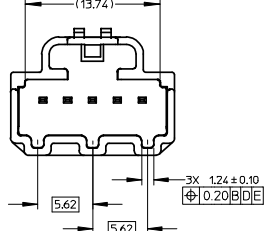

5 WAY POLARIZATION "B"

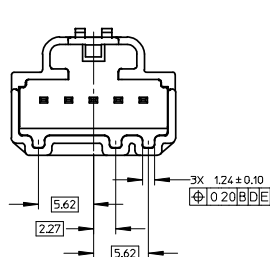

5 WAY POLARIZATION "C"

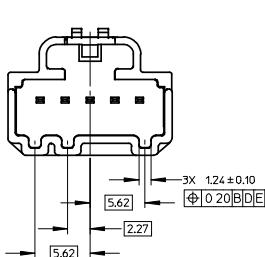

6 WAY POLARIZATION "A"

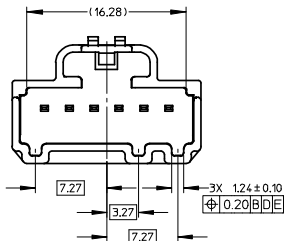

6 WAY POLARIZATION "B"

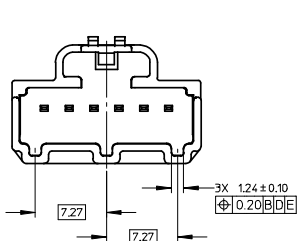

6 WAY POLARIZATION "C"

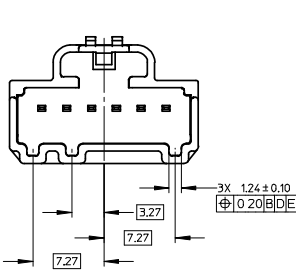

ENTER DESCRIPTION IEC NO: UAU2008-0767 DRAWN: MACHIGA 2008/07/08 CHKD: BOLLICK 2008/07/09 APPR: SMARCEAU 2008/07/09 REV: DESCRIPTION	QUALITY SYMBOLS ▽=0 ▽=0		GENERAL TOLERANCES (UNLESS SPECIFIED) mm INCH		DIMENSION STYLE MM ONLY		SCALE 4:1 DESIGN UNITS METRIC		THIRD ANGLE PROJECTION	
	4 PLACES ± --- ± ---	3 PLACES ± --- ± ---	2 PLACES ± 0.13 ± ---	1 PLACE ± 0.25 ± ---	DRAWN BY BOLLICK01 DATE 6/22/2007 CHECKED BY CDILLON DATE 6/22/2007 APPROVED BY DATE		TITLE FEMALE ASSEMBLY CHARTED SALES DRAWING		MATERIAL NO. SEE CHART DOCUMENT NO. SD-31109-003	
	DRAFT WHERE APPLICABLE MUST REMAIN WITHIN DIMENSIONS				ANGULAR ± 1/2°		SHEET NO. 4 OF 4		MOLEX INCORPORATED	
	THIS DRAWING CONTAINS INFORMATION THAT IS PROPRIETARY TO MOLEX INCORPORATED AND SHOULD NOT BE USED WITHOUT WRITTEN PERMISSION									