

**PLEASE CHECK WWW.MOLEX.COM FOR LATEST PART INFORMATION**

**Part Number:** [0310721012](#)  
**Status:** **Active**  
**Overview:** H-DAC™ 64 Single Row  
**Description:** 2.54mm (.100") H-DAC 64™, 5 Way Receptacle Assembly, Single-Row, Polarization C

**Documents:**

[Drawing \(PDF\)](#) [Product Specification PS-31100-0001 \(PDF\)](#)  
[Application Specification \(PDF\)](#) [RoHS Certificate of Compliance \(PDF\)](#)  
[Product Specification PS-31067-0001 \(PDF\)](#)

**General**

Product Family Crimp Housings  
 Series [31072](#)  
 Comments Polarization Option C, Brown  
 Overview [H-DAC™ 64 Single Row](#)  
 Product Name H-DAC 64™

**Physical**

Circuits (maximum) 5  
 Circuits Detail 5  
 Color - Resin Brown (Carmel), White  
 Gender Female  
 Glow-Wire Compliant No  
 Keying to Mating Part None  
 Lock to Mating Part Yes  
 Material - Resin Modified Polystyrene, Polyester  
 Number of Rows 1  
 Packaging Type Bag  
 Panel Mount No  
 Pitch - Mating Interface (in) 0.100 In  
 Pitch - Mating Interface (mm) 2.54 mm  
 Pitch - Term. Interface (in) 0.100 In  
 Pitch - Term. Interface (mm) 2.54 mm  
 Polarized to Mating Part Yes  
 Ports 1  
 Stackable No  
 Temperature Range - Operating -40°C to +100°C

**Electrical**

Current - Maximum per Contact 11A, 9A

**Material Info**

**Reference - Drawing Numbers**

Product Specification PS-31067-0001, PS-31100-0001  
 Sales Drawing SD-31109-003



image - Reference only

**EU RoHS**

**ELV and RoHS  
 Compliant  
 REACH SVHC  
 Contains SVHC: No  
 Halogen-Free  
 Status  
 Halogen-Free**

**China RoHS**



**Need more information on product  
 environmental compliance?**

Email [productcompliance@molex.com](mailto:productcompliance@molex.com)  
 For a multiple part number RoHS Certificate of Compliance, [click here](#)

Please visit the [Contact Us](#) section for any non-product compliance questions.

**Search Parts in this Series**

[31072Series](#)

**Mates With**

H-DAC 64™, 5 Way Male Housing Assembly [310721042](#) , [310721072](#)

**Use With**

See Product Spec

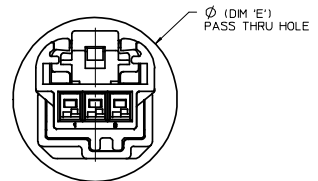
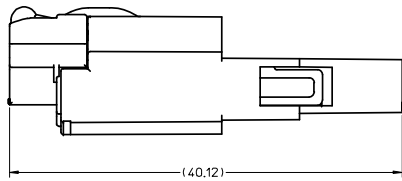
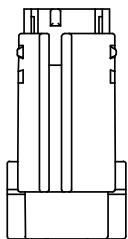

OVERALL MATED LENGTH

MALE AND FEMALE ASSEMBLY  
PASS THRU VIEW  
(CAD GENERATED)

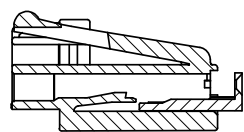
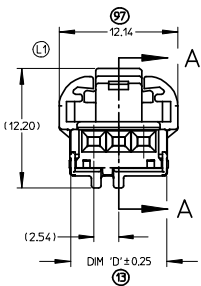
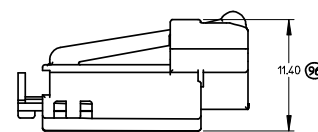

SECTION A-A  
SCALE 4:1

MATING SIDE

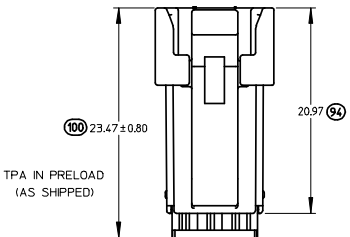

TPA IN PRELOAD  
(AS SHIPPED)

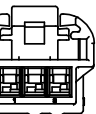

WIRE SIDE

- NOTES:
1. MATERIAL: HOUSING: SPS GLASS FILLED, COLOR SEE CHART.  
TPA: PBT
  2. PRODUCT SPECIFICATIONS - IN-LINE MATING INTERFACE: PS-31067-0001.  
- DIRECT CONNECT MATING INTERFACE: PS-31100-0001
  3. PACKAGING SPECIFICATION: DRAWING PK-30907-737.
  4. MATES WITH: SEE SALES DRAWINGS SD-31100-003 (MALE IN-LINE),  
SD-31197-003 (RIGHT ANGLE HEADER), SD-31101-114 (VERTICAL  
"WINGED" HEADER), AND SD-31206-003 (VERTICAL HEADER).
  5. TERMINAL PLATING: TIN (Sn) OVERALL, BRITE FINISH.  
THICKNESS = 15 MICROMETER MINIMUM,  
NICKEL (Ni) UNDERPLATE OVERALL.
  6. PACKAGING: PLEASE REFERENCE MOLEX SPECIFICATION PS-34646-001,  
AVAILABLE AT WWW.MOLEX.COM. (REFERENCE: TPAs THAT ARE FOUND IN  
SEATED (FINAL LOCK) POSITION)
  7. APPLICATION SPECIFICATION: AS-31067-100.

<b>ENTER DESCRIPTION</b> IEC NO. UAU2008-0767 DRAWN: MACHUGA 2008/07/08 CHECKED: CHYKOBLOCK 2008/07/09 APPR: SMARCEAU 2008/07/09	<b>QUALITY SYMBOLS</b> =0 =0	<b>GENERAL TOLERANCES (UNLESS SPECIFIED)</b>		<b>DIMENSION STYLE</b> MM ONLY	SCALE 1:1	DESIGN UNITS METRIC	THIRD ANGLE PROJECTION		
		4 PLACES ± --- ± ---	3 PLACES ± --- ± ---	2 PLACES ± 0.13 ± ---	1 PLACE ± 0.25 ± ---	ANGLAR ± 1/2°	DRAFT WHERE APPLICABLE MUST REMAIN WITHIN DIMENSIONS	DRAWN BY BDLCK01	DATE 6/22/2007
		CHECKED BY CDILLON		DATE 6/22/2007		APPROVED BY DATE		MATERIAL NO. SEE CHART	DOCUMENT NO. SD-31109-003
		MOLEX INCORPORATED						SHEET NO. 1 OF 4	

FEMALE VIEWED FROM MATING SIDE

3 WAY POLARIZATION 'A'

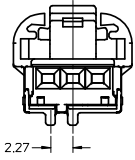

3 WAY POLARIZATION 'B'

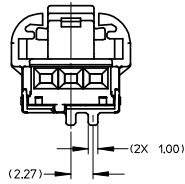

3 WAY POLARIZATION 'C'

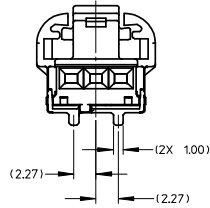

4 WAY POLARIZATION 'A'

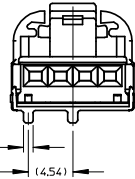

4 WAY POLARIZATION 'B'

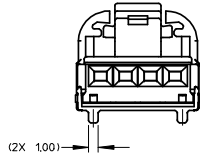

4 WAY POLARIZATION 'C'

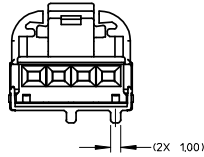

5 WAY POLARIZATION 'A'

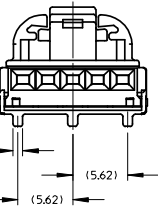

5 WAY POLARIZATION 'B'

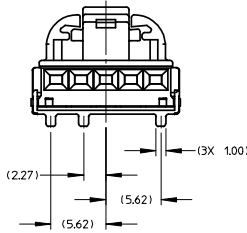

5 WAY POLARIZATION 'C'

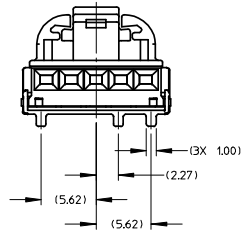

6 WAY POLARIZATION 'A'

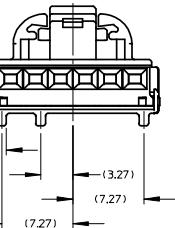

6 WAY POLARIZATION 'B'

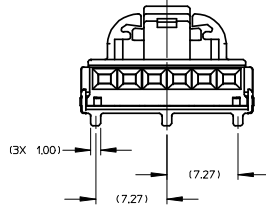

6 WAY POLARIZATION 'C'

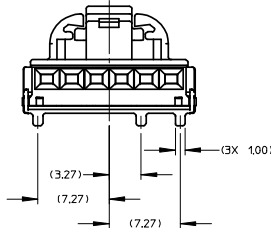

BILL OF MATERIALS						MATING ASSEMBLIES PART NUMBERS					
ASSEMBLY PART NUMBER	DESCRIPTION	PART NUMBER	DESCRIPTION	COLOR	DIM 'D'	DIM 'E'	INLINE MALE ASSEMBLY W/O XMAS SLOT	INLINE MALE ASSEMBLY W/ XMAS SLOT	RIGHT ANGLE MALE HEADER ASSEMBLY	VERTICAL MALE HEADER ASSEMBLY	VERTICAL MALE WINGED HEADER ASSY
31067-1010	3 WAY FEMALE ASSEMBLY POLARIZATION 'A'	31111-0030	FEMALE HOUSING	BLACK	9.80	16.76	31067-1040	31067-1070	31100-0030 NOT TOOLED	31101-0030 NOT TOOLED	TBD
		31113-0030	TPA	NATURAL (WHITE)							
31067-1011	3 WAY FEMALE ASSEMBLY POLARIZATION 'B'	31111-0031	FEMALE HOUSING	GRAY	9.80	16.76	31067-1041	31067-1071	31100-0031 NOT TOOLED	31101-0031 NOT TOOLED	TBD
		31113-0030	TPA	NATURAL (WHITE)							
31067-1012	3 WAY FEMALE ASSEMBLY POLARIZATION 'C'	31111-0032	FEMALE HOUSING	BROWN	9.80	16.76	31067-1042	31067-1072	31100-0032 NOT TOOLED	31101-0032 NOT TOOLED	TBD
		31113-0030	TPA	NATURAL (WHITE)							
31068-1010	4 WAY FEMALE ASSEMBLY POLARIZATION 'A'	31157-0040	FEMALE HOUSING	BLACK	12.34	18.25	31068-1040	31068-1070	31100-0040	31101-0040	31101-1140
		31158-0040	TPA	NATURAL (WHITE)							
31068-1011	4 WAY FEMALE ASSEMBLY POLARIZATION 'B'	31157-0041	FEMALE HOUSING	GRAY	12.34	18.25	31068-1041	31068-1071	31100-0041	31101-0041	31101-1240
		31158-0040	TPA	NATURAL (WHITE)							
31068-1012	4 WAY FEMALE ASSEMBLY POLARIZATION 'C'	31157-0042	FEMALE HOUSING	BROWN	12.34	18.25	31068-1042	31068-1072	31100-0042	31101-0042	31101-1340
		31158-0040	TPA	NATURAL (WHITE)							
31072-1010	5 WAY FEMALE ASSEMBLY POLARIZATION 'A'	31160-0050	FEMALE HOUSING	BLACK	14.88	20.25	31072-1040	31072-1070	31100-0050 NOT TOOLED	31101-0050 NOT TOOLED	TBD
		31161-0050	TPA	NATURAL (WHITE)							
31072-1011	5 WAY FEMALE ASSEMBLY POLARIZATION 'B'	31160-0051	FEMALE HOUSING	GRAY	14.88	20.25	31072-1041	31072-1071	31100-0051 NOT TOOLED	31101-0051 NOT TOOLED	TBD
		31161-0050	TPA	NATURAL (WHITE)							
31072-1012	5 WAY FEMALE ASSEMBLY POLARIZATION 'C'	31160-0052	FEMALE HOUSING	BROWN	14.88	20.25	31072-1042	31072-1072	31100-0052 NOT TOOLED	31101-0052 NOT TOOLED	TBD
		31161-0050	TPA	NATURAL (WHITE)							
31073-1010	6 WAY FEMALE ASSEMBLY POLARIZATION 'A'	31163-0060	FEMALE HOUSING	BLACK	17.42	22.75	31073-1040	31073-1070	31100-0060 NOT TOOLED	31101-0060 NOT TOOLED	TBD
		31164-0060	TPA	NATURAL (WHITE)							
31073-1011	6 WAY FEMALE ASSEMBLY POLARIZATION 'B'	31163-0061	FEMALE HOUSING	GRAY	17.42	22.75	31073-1041	31073-1071	31100-0061 NOT TOOLED	31101-0061 NOT TOOLED	TBD
		31164-0060	TPA	NATURAL (WHITE)							
31073-1012	6 WAY FEMALE ASSEMBLY POLARIZATION 'C'	31163-0062	FEMALE HOUSING	BROWN	17.42	22.75	31073-1042	31073-1072	31100-0062 NOT TOOLED	31101-0062 NOT TOOLED	TBD
		31164-0060	TPA	NATURAL (WHITE)							

<b>ENTER DESCRIPTION</b> IEC NO. UAU2008-0767 DRAWN: TMACHUGA 2008/07/08 CHYKDBOICK 2008/07/09 APPR: SMARCEAU 2008/07/09	<b>QUALITY SYMBOLS</b> ▽=0 ▽=0	<b>GENERAL TOLERANCES (UNLESS SPECIFIED)</b>		DIMENSION STYLE <b>MM ONLY</b>	SCALE <b>1:1</b>	DESIGN UNITS <b>METRIC</b>	THIRD ANGLE PROJECTION	
		4 PLACES ± mm INCH ± ---		DRAWN BY BDI CK01	DATE 6/22/2007	TITLE <b>FEMALE ASSEMBLY CHARTED SALES DRAWING</b>		
		3 PLACES ± --- ± ---		CHECKED BY CDILLON	DATE 6/22/2007	MOLEX INCORPORATED		
		2 PLACES ± 0.13 ± ---		APPROVED BY DATE	MATERIAL NO. <b>SEE CHART</b>	DOCUMENT NO. <b>SD-31109-003</b>	SHEET NO. 2 OF 4	

DRAFT WHERE APPLICABLE MUST REMAIN WITHIN DIMENSIONS  
 THIS DRAWING CONTAINS INFORMATION THAT IS PROPRIETARY TO MOLEX INCORPORATED AND SHOULD NOT BE USED WITHOUT WRITTEN PERMISSION

# REFERENCE ONLY

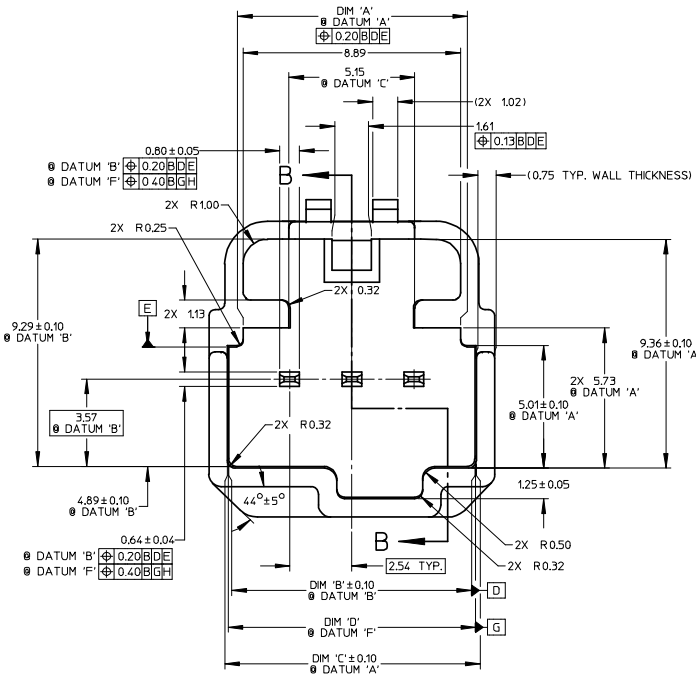

MATING INTERFACE DETAIL  
SCALE 10:1

RECOMMENDED MATING MATERIAL: SPS, 30% GLASS FILLED.

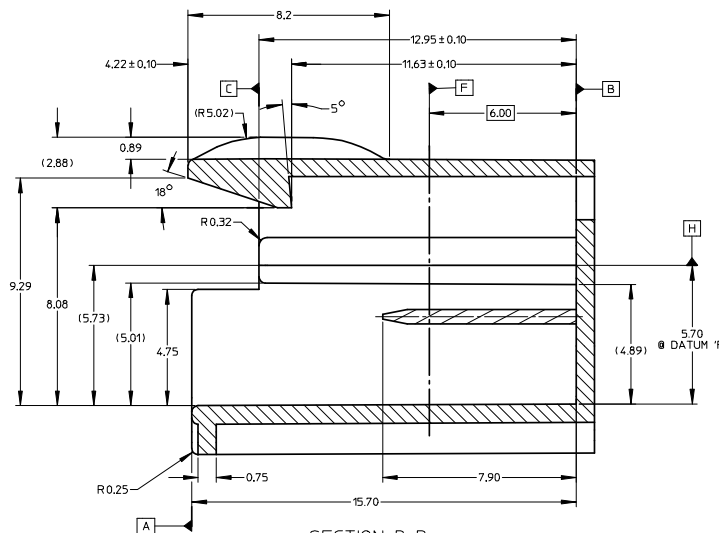

SECTION B-B  
SCALE 10:1

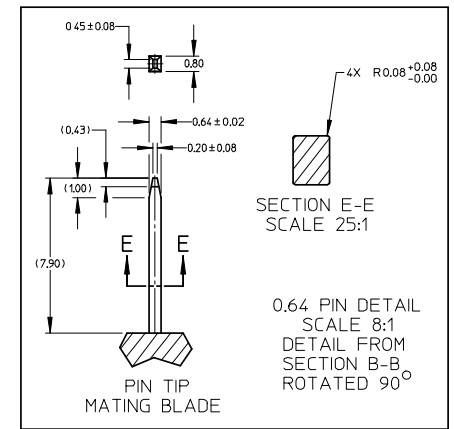

SECTION E-E  
SCALE 25:1

0.64 PIN DETAIL  
SCALE 8:1  
DETAIL FROM  
SECTION B-B  
ROTATED 90°

DIMENSIONS FOR DIRECT CONNECT

CIRCUIT SIZE	DIM 'A'	DIM 'B'	DIM 'C'	DIM 'D'
3	8.89	10.05	10.19	10.11
4	11.20	12.59	12.73	12.65
5	13.74	15.13	15.27	15.19
6	16.28	17.67	17.81	17.73

RECOMMENDED DIRECT CONNECT INFO  
FOR MATING FEMALE PARTS ONLY

<b>ENTER DESCRIPTION</b> IEC NO. UAU2008-0767 DRAWN BY: MACHUGA 2008/07/08 CHECKED BY: CHYKBD01 2008/07/09 APPROVED BY: SHARCEAU 2008/07/09	<b>QUALITY SYMBOLS</b> ▽=0 ▽=0	<b>GENERAL TOLERANCES (UNLESS SPECIFIED)</b> mm INCH 4 PLACES ± --- ± --- 3 PLACES ± --- ± --- 2 PLACES ± 0.13 ± --- 1 PLACE ± 0.25 ± --- ANGULAR ±1/2°	<b>DIMENSION STYLE</b> MM ONLY	SCALE 1:1 DESIGN UNITS METRIC THIRD ANGLE PROJECTION	DRAWN BY DATE BDLCK01 6/22/2007 CHECKED BY DATE CDILLON 6/22/2007 APPROVED BY DATE	TITLE <b>FEMALE ASSEMBLY CHARTED SALES DRAWING</b>
	<b>DRAFT WHERE APPLICABLE MUST REMAIN WITHIN DIMENSIONS</b>	MATERIAL NO. <b>SEE CHART</b>	DOCUMENT NO. <b>SD-31109-003</b>	SHEET NO. 3 OF 4		
	THIS DRAWING CONTAINS INFORMATION THAT IS PROPRIETARY TO MOLEX INCORPORATED AND SHOULD NOT BE USED WITHOUT WRITTEN PERMISSION					
	MOLEX INCORPORATED		MOLEX INCORPORATED			
	DRAWN BY: MACHUGA 2008/07/08		CHECKED BY: CHYKBD01 2008/07/09			

# REFERENCE ONLY

3 WAY  
POLARIZATION "A"

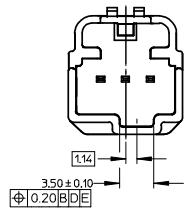

3 WAY  
POLARIZATION "B"

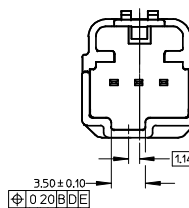

3 WAY  
POLARIZATION "C"

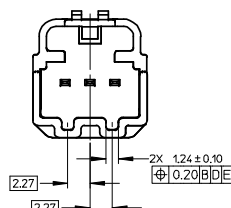

4 WAY  
POLARIZATION "A"

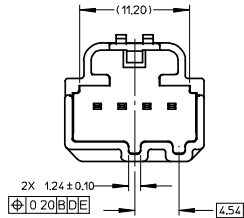

4 WAY  
POLARIZATION "B"

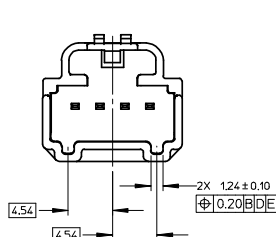

4 WAY  
POLARIZATION "C"

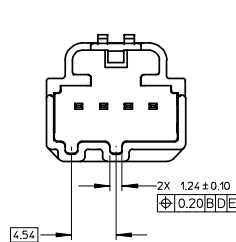

5 WAY  
POLARIZATION "A"

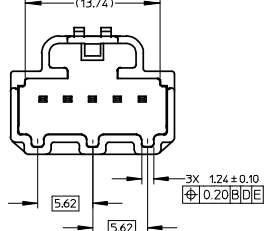

5 WAY  
POLARIZATION "B"

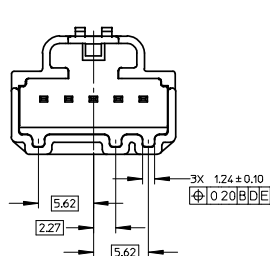

5 WAY  
POLARIZATION "C"

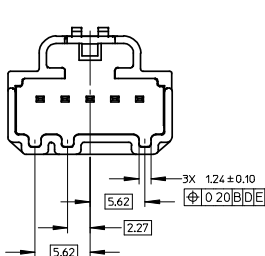

6 WAY  
POLARIZATION "A"

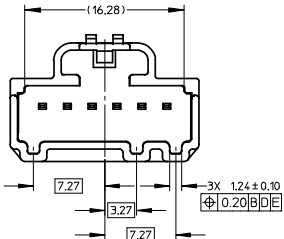

6 WAY  
POLARIZATION "B"

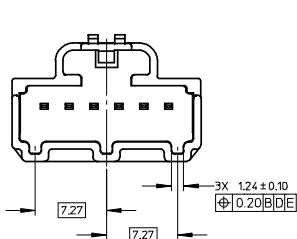

6 WAY  
POLARIZATION "C"

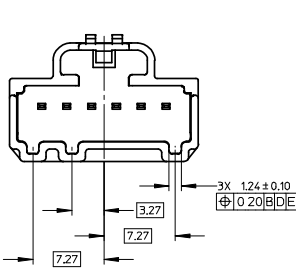

<b>ENTER DESCRIPTION</b> IEC NO: UAU2008-0767 DRAWN: MACHIGA 2008/07/08 CHKD: BDI CK 2008/07/09 APPR: SMARCEAU 2008/07/09 REV:	QUALITY SYMBOLS ▽=0 ▽=0	GENERAL TOLERANCES (UNLESS SPECIFIED) mm INCH	DIMENSION STYLE MM ONLY	SCALE 4:1	DESIGN UNITS METRIC	THIRD ANGLE PROJECTION	
	4 PLACES ± --- ± --- 3 PLACES ± --- ± --- 2 PLACES ± 0.13 ± --- 1 PLACE ± 0.25 ± ---	ANGULAR ± 1/2°	DRAFT WHERE APPLICABLE MUST REMAIN WITHIN DIMENSIONS	MATERIAL NO. SEE CHART	DATE 6/22/2007	DATE 6/22/2007	TITLE FEMALE ASSEMBLY CHARTED SALES DRAWING
	APPROVED BY	DATE	MOLEX INCORPORATED	DOCUMENT NO. SD-31109-003	SHEET NO. 4 OF 4	THIS DRAWING CONTAINS INFORMATION THAT IS PROPRIETARY TO MOLEX INCORPORATED AND SHOULD NOT BE USED WITHOUT WRITTEN PERMISSION	
	SIZE D						