

**For LCD Monitor ( PC + Video + DVI) Interface Controller  
For 1280X768, 1600X1024, 1600x1200 Resolutions TFT LCD**

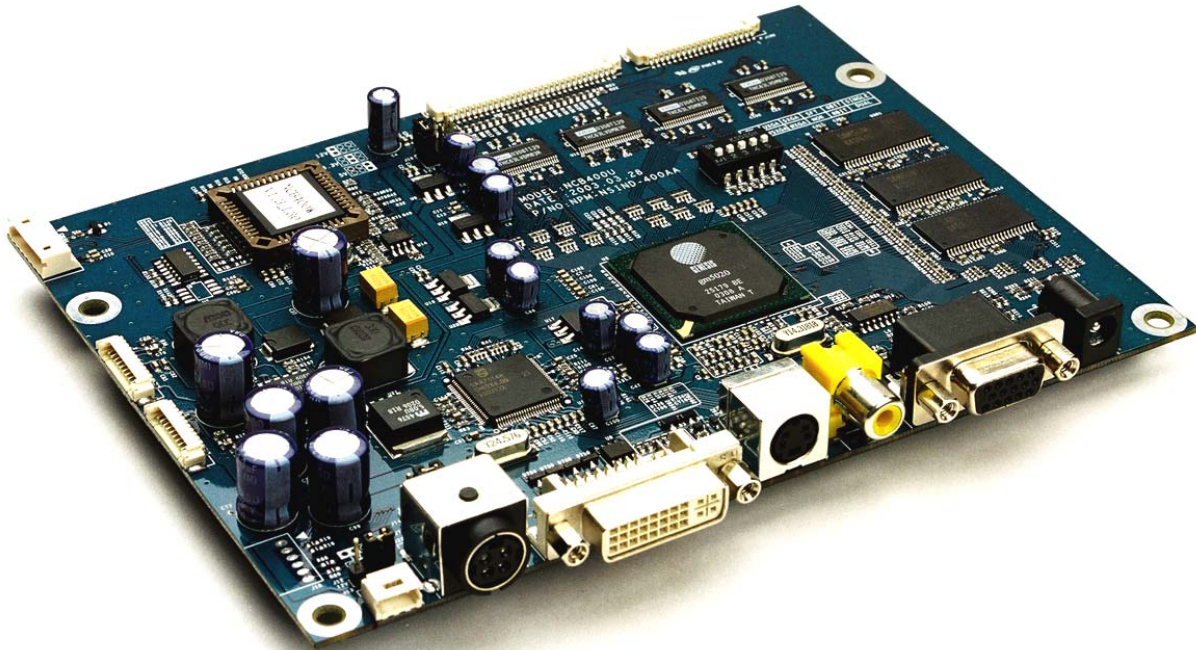

## TFT LCD Monitor Control Board

**NCB400U4-DS-AB**

**May 2003**

**Kordis Media Co., Ltd.  
3F, 1006-9, Sadang-Dong,  
Dongjak-Ku, Seoul 156-090, Korea  
TEL : 82-2-585-8347  
FAX : 82-2-585-8391  
URL : [www.kordis.co.kr](http://www.kordis.co.kr)**

**CONTENT**

- INTRODUCTION ..... 4
- GENERAL SPECIFICATION ..... 5
- SYSTEM DESIGN ..... 8
- BLOCK DIAGRAM ..... 9
- ASSEMBLY NOTES ..... 10
- CONNECTION & OPERATION ..... 13
- OSD ..... 14
- OSD FUNCTION ..... 15
- CONNECTOR, PINOUT & JUMPER ..... 21
- CONTROLLER DIMENSIONS ..... 30
- APPLICATION NOTES ..... 31
- TROUBLESHOOTING ..... 32
- APPLICABLE GRAPHIC MODE ..... 33
- ACCESSORY ..... 34
- APPENDIX ..... 35

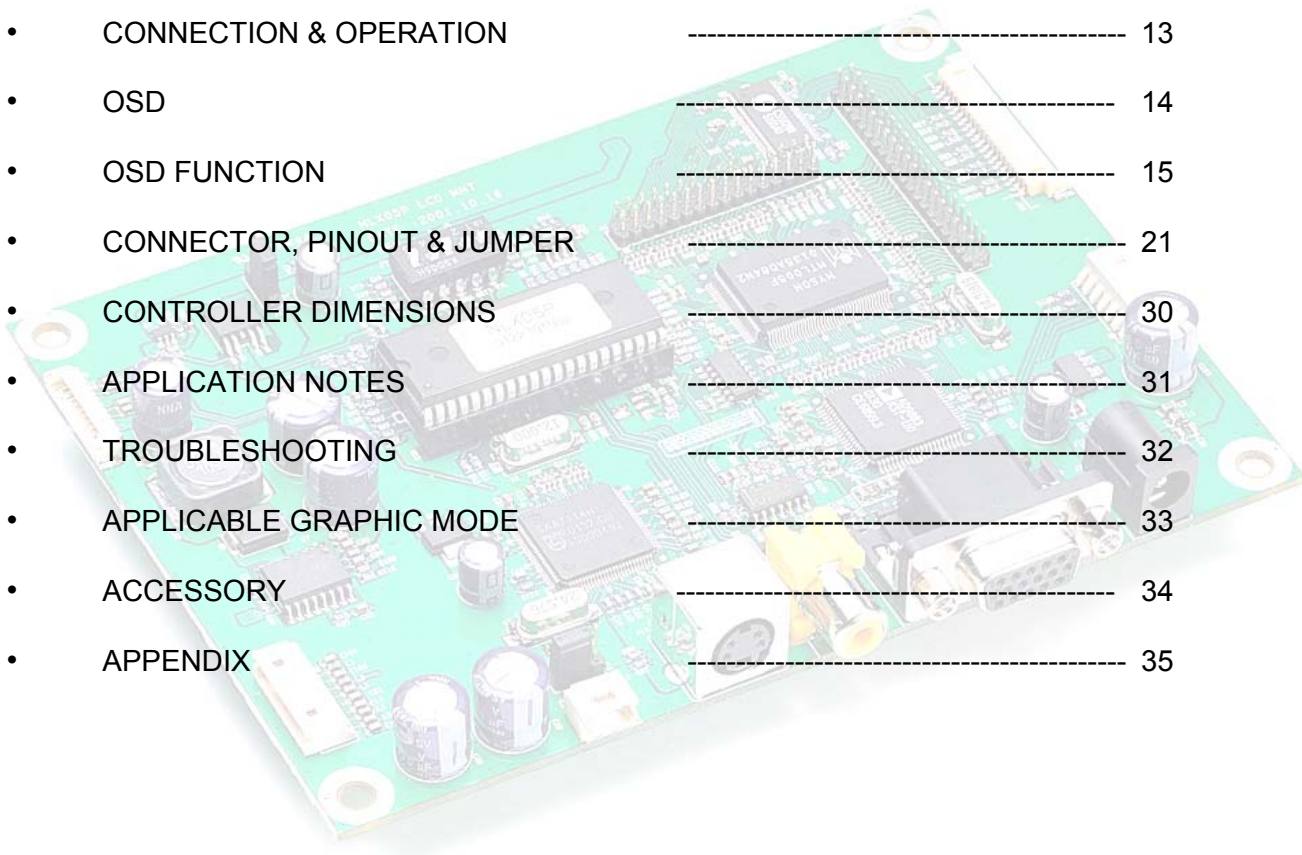

**Revision History**

No	Data	Revision	Page
1	Preliminary Release	AA	
2	2003. 05 Update Data Sheet for NCB400U4	AB	

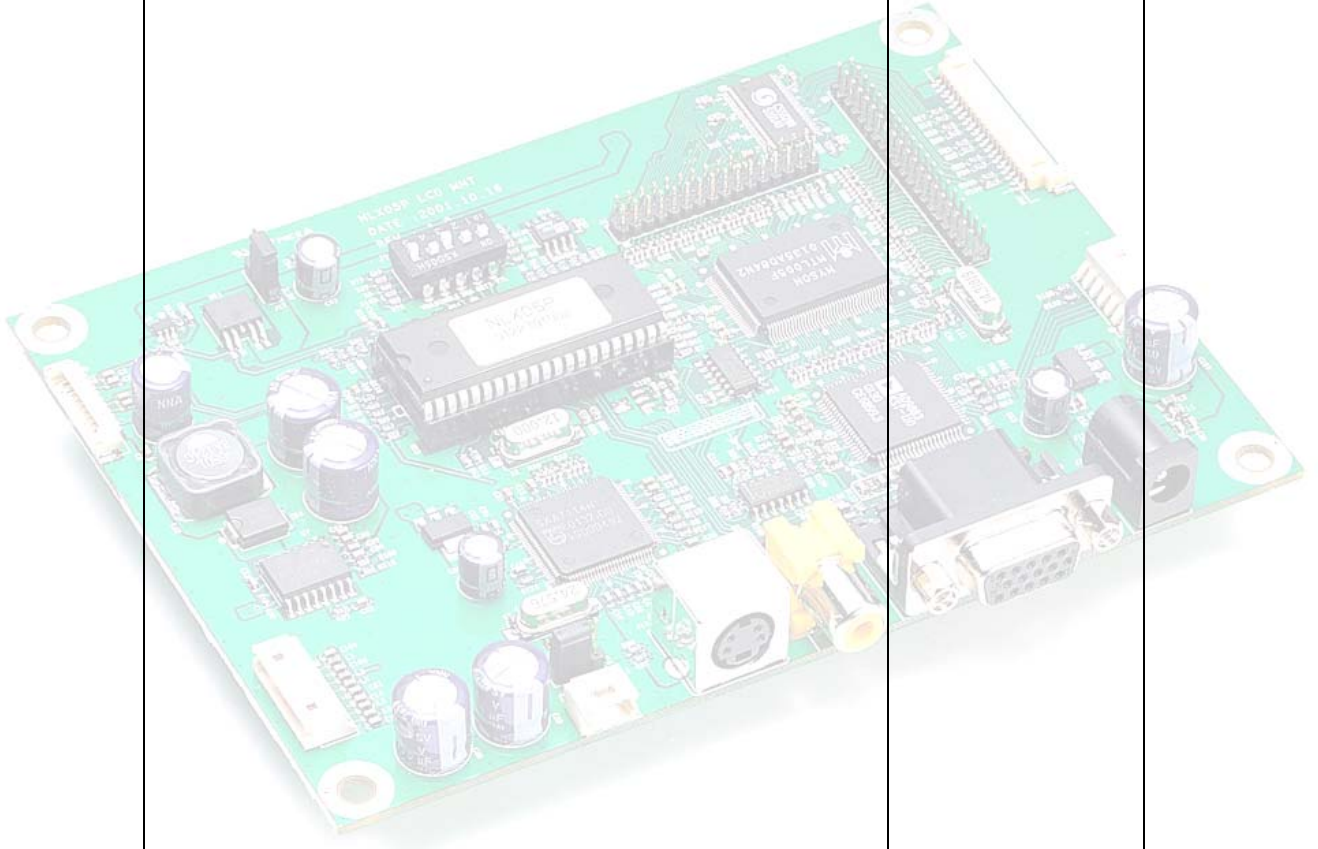

## INTRODUCTION

Designed for LCD monitor and other flat panel display application the NCB400U4 controller provides an auto-input synchronization and easy to use interface controller for:

- ▶ TFT (active matrix) LCD panels of 1600x1024 and 1600x1200 resolutions.
- ▶ Computer video signals of VGA, SVGA, XGA, WXGA, SXGA and UXGA standard.
- ▶ Video signals of NTSC, PAL standard
- ▶ Input Signal Support
  - All VESA standard

## HOW TO PROCEED

- ▶ Ensure that you have all parts & they are correct, refer to:
  - Connection diagram
  - Connector reference
  - Assembly notes
- ▶ Check controller switch & jumper settings (errors may damage the panel)
- ▶ Prepare the PC & Video
- ▶ Connect the parts
- ▶ Understand the operation & functions

## IMPORTANT USAGE NOTE

This equipment is for use by developers and integrators. The manufacturer accepts no liability for damage or injury caused by the use of this product. It is the responsibility of the developer, integrators or other users of this product to:

- Ensure that all necessary and appropriate safety measures are taken.
- Obtain suitable regulatory approvals as may be required.
- Check power settings to all component parts before connection.

## DISCLAIMER

There is no implied or expressed warranty regarding this material.

**GENERAL SPECIFICATION**

No.	Item	Description		
1	Model name	For WXGA Panel	NCB400W4	
		For UXGA Panel	NCB400U4	
2	LCD Module	WXGA, UXGA		
3	Signal Input	Analog RGB Input. NTSC/PAL		
4	Resolution Support	H: 31 ~ 80kHz		
		V: 55 ~ 76Hz		
5	OSD Control	Menu, Left, Right, Up, Down, Source, Power		5 keys
	Plug & Play	VESA DDC 2B Ver1.3		
6	Power Connector	Input	Type: IEC320 MALE 3Line Connector	
7.	Power Consumption	Supply Voltage	12V, 18V or 24V	cf) Back Light Inverter
		Max Power	130W (With Back Light Inverter)	Note1)
8	Signal Connector	Analog	DSUB 15P(R, G, B Separate H, V Sync)	
		Digital	DVI-D(TMDS)	
		Video	MINIDIN-4P(SVHS), RCA(CVBS)	

**ELECTRICAL SPECIFICATION**
**Input characteristic**

Description	Signal	Unit	Min	Typical	Max	Remarks
Power In (24V)						
	Input	Vdc	22.8	24.0	25.2	
	Consumption	Watt		120		
Power In (18V)						
	Input	Vdc	17.0	18.0	19.0	
	Consumption	Watt		60		
Power In (12Vdc)						
	Input	Vdc	11.4	12.0	12.6	
	Consumption	Watt		50		
RGB Input						
	Analog RGB	Vp-p	0	0.7	-	
	Sync	Vdc	0	5	5.5	
	H Frequency	KHz	31		80	Depends on Mode
	V Frequency	Hz	55	60	75	
DVI Input						
	TMDS	mVp-p	450	500	900	
NTSC/PAL						
	Y/CVBS	Vp-p	0.7	1.0	1.4	
	C	Vp-p	0.6	0.8	1.0	

**Output Characteristics**

Description	Signal	Unit	Min	Typical	Max	Remarks
Panel Power						
	LCD Power (15V)	Vdc	14.25	15	15.75	Jumper option (Representative 12V)
	LCD Power (18V)	Vdc	11.4	18	12.6	
	LCD Power (12V)	Vdc	11.4	12	12.6	
	LCD Power(5V)	Vdc	4.5	5	5.5	Jumper option
	LCD Power(3.3V)	Vdc	3.16	3.3	3.5	Jumper option
LVDS Interface						
	Differential output	Vp-p (mV)	250	350	450	Different +/-
Inverter Interface						
	Power out	Vdc	22.8	24	25.2	LC300W01
			14.25	15	15.75	LM220W1
	On/Off control	V	0		3.3	L=off, H=on
	Brightness control	V	3.3		0	LC171W, LM201U
			0		5V	LC300W
			Step	0		100

**SYSTEM DESIGN**

A typical LCD based display system utilizing this controller is likely to comprise the following.

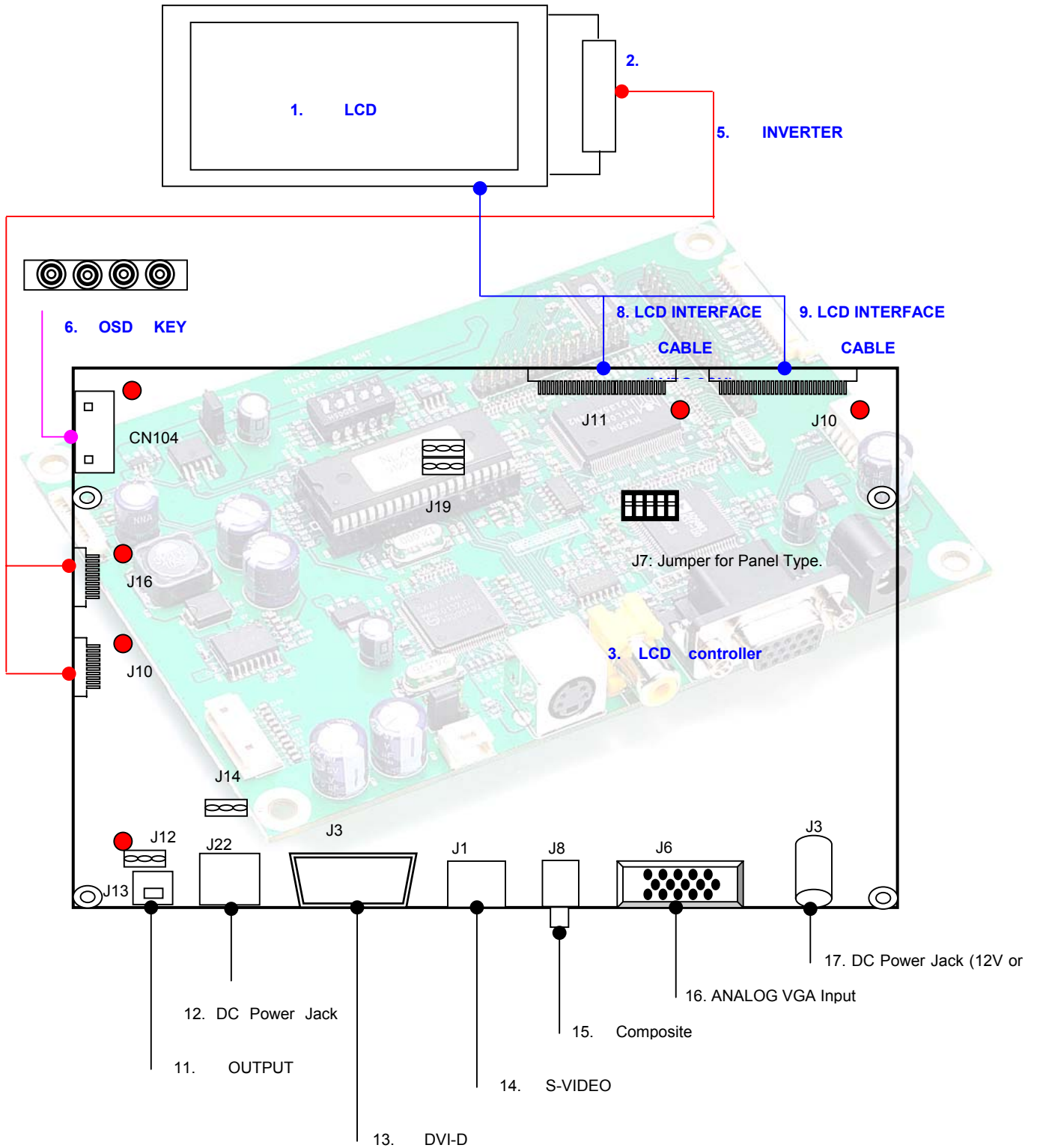



**BLOCK DIAGRAM**

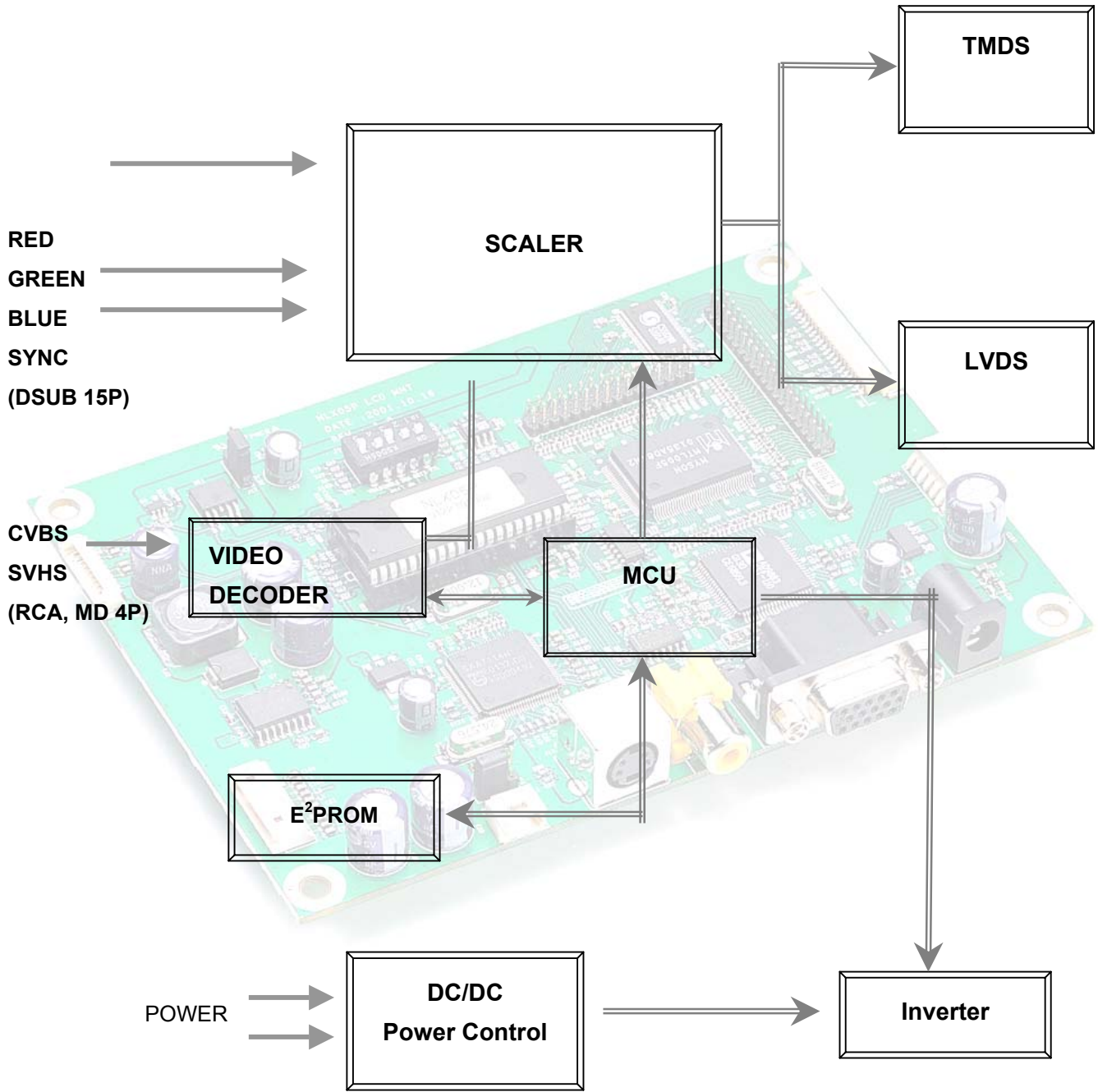

## ASSEMBLY NOTES

This controller is designed for monitors and custom display projects using 1280x768 or 1600x1200, resolution TFT LCD panels with a VGA, SVGA, XGA, WXGA, SXGA, WSXGA and UXGA signal input. The following provides some guidelines for installation and preparation of a finished display solution.

**Preparation:** Before proceeding it is important to familiarize yourself with the parts making up the system and the various connectors, mounting holes and general layout of the controller. As much as possible connectors have been labeled. Guides to connectors and mounting holes are shown in the following relevant sections.

- 1. LCD Panel:** This controller has TTL and LVDS interface logic on the Board for different kind of TFT LCD panel. For the other type of LCD interface like Panel Link interface and etc, this board can accommodate a daughter board instead of on-board LCD interface. Due to the different signal timing and electrical characteristics from each LCD panel manufacturer, for selecting LCD interface type and resolution, put jumper marked J5 on the right position following LCD panel specification. For selecting DC power level, put jumper marked J19 on the right position. Supplied power level depends on LCD panel specification.
- 2. Controller:** Handle the controller with care as static charge may damage electronic components, Make sure correct jumper and switches settings to match the target LCD panel
- 3. LCD connector board:** Different makers and models of LCD panel require different panel signal connectors and different pin assignments.
- 4. LCD signal cables:** In order provide a clean signal it is recommended that LCD signal cables should not longer than 30cm. If loose wire cabling is utilized these can be a made into a harness with cable ties. Care should be taken when you place the cables to avoid signal interface. Additionally it may necessary in some systems to add ferrite cores to the cables to minimize signal noise.
- 5. Inverter:** This will be required for the backlight of an LCD, some LCD panel have an inverter built in. As LCD panels may have 1 or more backlight tubes and the power requirements for different panel backlights may vary it is important to match the inverter in order to obtain optimum performance. See application notes for more information on connection.
- 6. Inverter cable:** Different inverter models require different cables and different pin assignment. Make sure the correct cable pin out to match the inverter. Unsuitable cable pins out may damage the inverter.
- 7. AV cable:** Standard composite or S-video cables can be used. Reasonable quality cables should be used to avoid image quality degradation.
- 8. OSD Button:** See Operational Function section.

**9. 3 Color LED:** This LED shows the state of controller.

- Green – Normal state
- Off – Off mode (Can't find video signals)
- Amber – DPMS mode

**10. Power switch:** This switch is located on OSD button board.

**11. Power input:** Proper power is required to supply power for the controller, the Inverter and the LCD panel

**12. VGA Input Cable:** As this may affect regulatory emission test result, a suitably shielded cable should be utilized.

**EMI:** Shielding will be required for passing certain regulatory emissions tests. Also the choice of video board and power supply can affect the test result.

**Consideration should be given to:**

- Electrical insulation.
- Grounding.
- EMI shielding.
- Heat & ventilation

**Caution:** Ensure that the adequate insulation is provided for all areas of the PCB with special attention to high voltage parts such as the inverter.

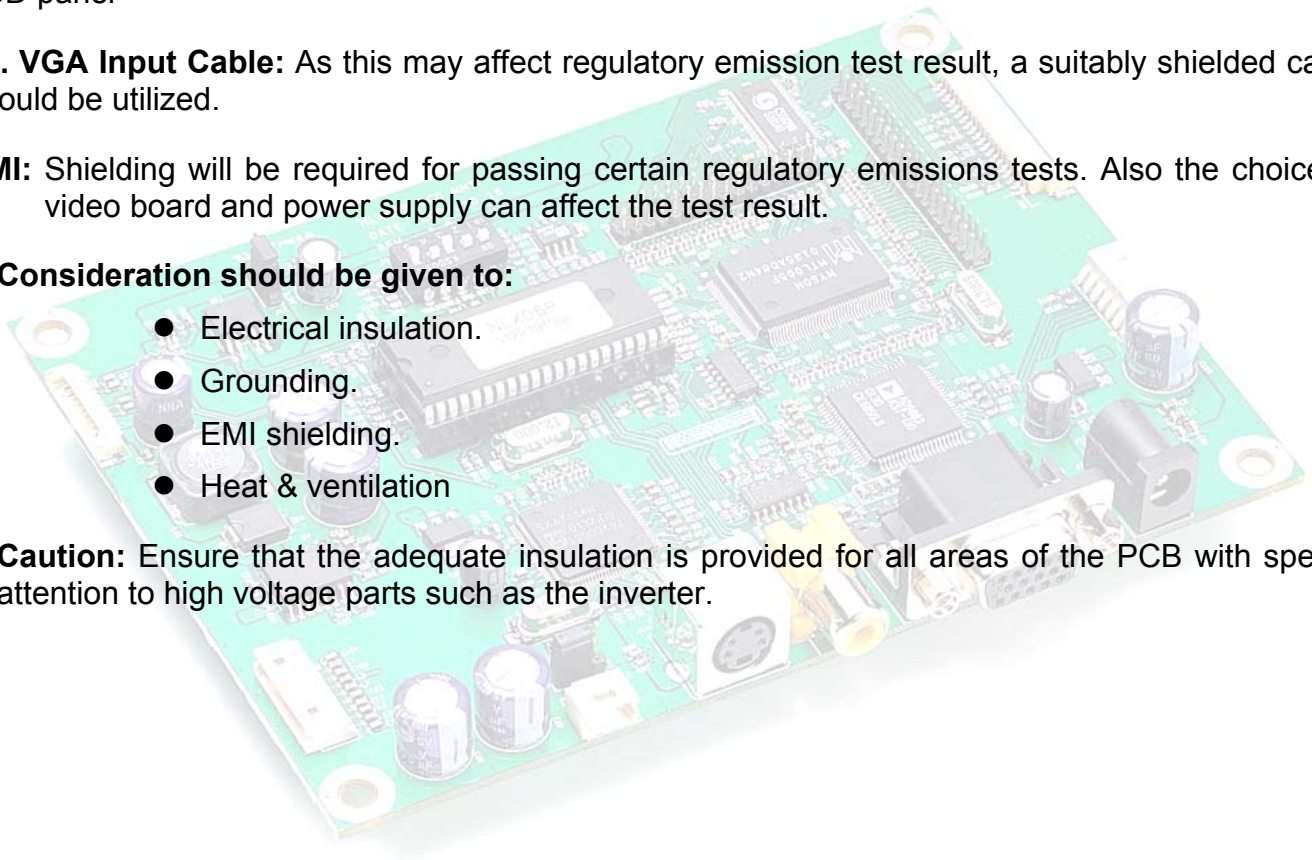

### 13. Setup for operation

Once the circuit has been connected, a setup procedure for optimal is requires a few minutes  
The following instructions are likely to form the basis of the finished product operation manual.

#### PC Settings

The PC needs to be set to an appropriate graphics mode that has the same resolution with the LCD panel to have clear screen image. And the vertical refresh rate should be set to one of 56~75Hz, non – interlaced signal.

#### LCD display System Settings

The OSD (On Screen Display) provides certain functions to have clear image and others. This board supports 5 buttons OSD operation as a standard. The control functions defined on OSD operation are as below.

#### Pc Graphics Output: A few guidelines:

- Signal quality is very important, if there is noise or instability in the PC graphics output this may result in visible noise on the display
- Refer to the graphic modes table in specification section for supported modes.
- Non-interlaced & interlaced video input is acceptable.

**Important: please read the application notes section for more information.**

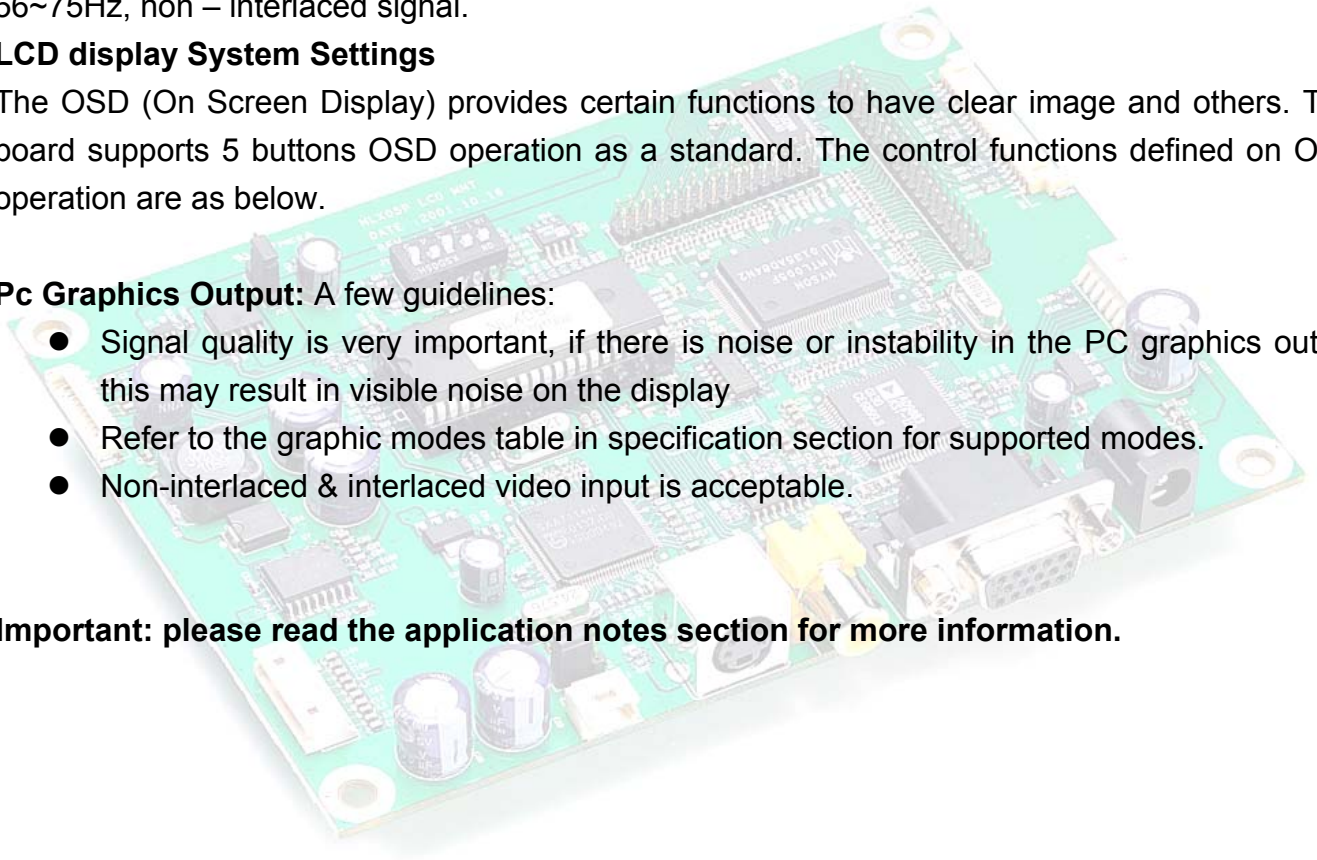

## CONNECTION & OPERATION

**CAUTION:** Never connect or disconnect parts of the display system when the system is powered up as this may cause serious damage.

### CONNECTION

- 1. LCD panel & Inverter:** Connect the inverter (if it is not built- in the panel) to the CCFT lead connector of the LCD panel.
- 2. LVDS type panels:** Plug the signal cables direct to J100 of the controller board for 1 channel interface panel or J11 for 2 channel interface panel. Plug the other end of cables to the LCD connector board
- 3. Inverter & Controller:** Plug the inverter cable to J10, 16 of the controller board and another end to the connector on the inverter.
- 4. Function switch & Controller:** Plug the OSD switch mount cable to J2 of the controller board and another end to the OSD board.
- 5. Jumpers:** Check all jumpers J12 (External power Setting), J11 (Input power Setting) and J19(Target Panel Power setting) are set correctly. Details referring the jumpers setting table (in the following section)
- 6. VGA cable & Controller:** Plug the VGA cable to the connector J6 of the controller board.
- 7. DIV-D Cable & Controller:** Plug the DVI-D Cable to the connector J3 of the controller board.
- 8. S/C Video Cable & Controller:** Plug S-Video Cable to the connector J1, C-Video Cable to the J8
- 9. Power supply to Controller:** Plug the DC 12V/18V power in to the connector J2 or DC 24V power in to the connector J22 of controller board.
- 10. Power on:** Switch on the controller board and panel by using the OSD switch mount.

### General:

- If you use supplied cables & accessories, ensure that they are correct for the model of the panel and the controller.
- If you make your own cables & connectors, refer carefully to both the panel & inverter specifications and the section in this manual, “Connectors, Pin outs & Jumpers” to ensure the correct pin to pin wiring.

### PC Setting:

The controller has been designed to take a very wide range of input signals however to optimize the PC’s graphic performance we recommend choosing 60Hz vertical refresh rate – this will not cause screen flicker.

**OSD Control Board**

The OSD (On Screen Display) provides certain functions to have clear image and others. This board supports 4 buttons OSD operation as a standard. The control functions defined on OSD operation are as below. (unit: mm)

Appearance

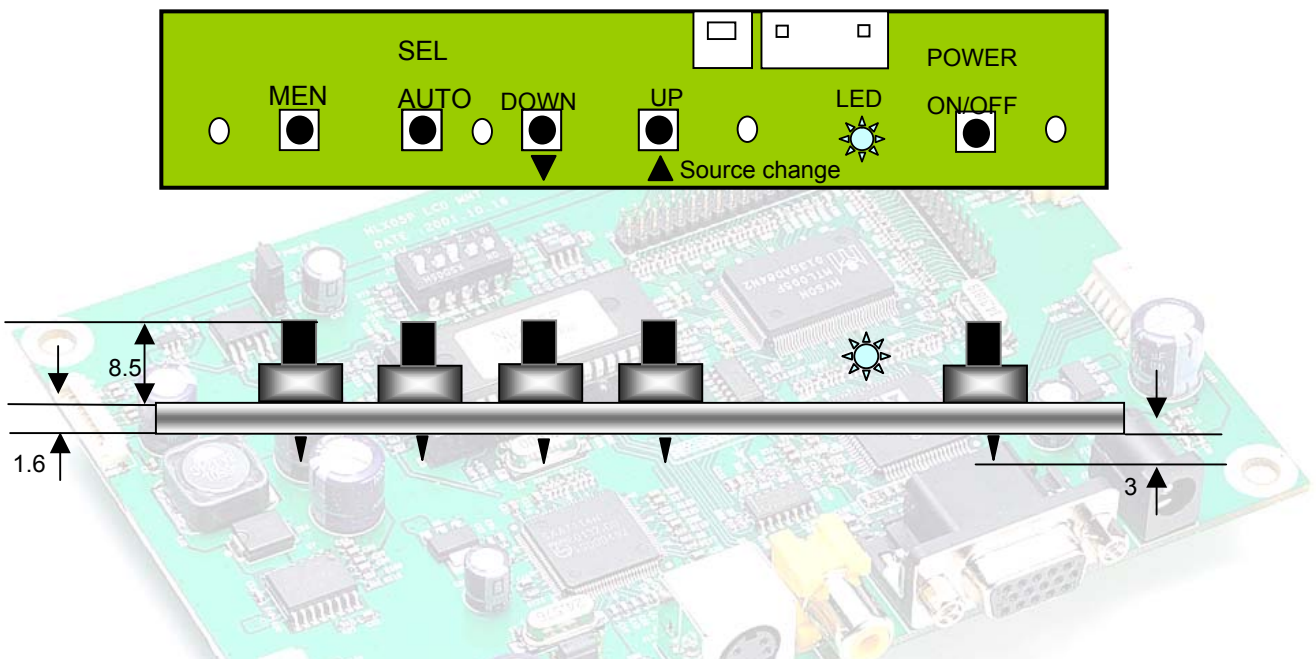

Button	Function	Status	HOT Key
Power	Power on/off	On/Off	
Menu	Activate menu		
Select	Menu Select		Auto setting
LED	Indicates operation status	Green/ Off/ Amber	
DOWN, UP ▼ ▲	Cursor control(Value Control) Down(Decrement)/Up(Increment)		UP : Source change

The chosen OSD settings will be stored in memory. The OSD menu can be cleared from the screen from the screen by moving the selection bar to the **EXIT MENU** icon pressing the **SEL** button otherwise it will be automatically cleared after a few second of non-use

## OSD MAIN MENU

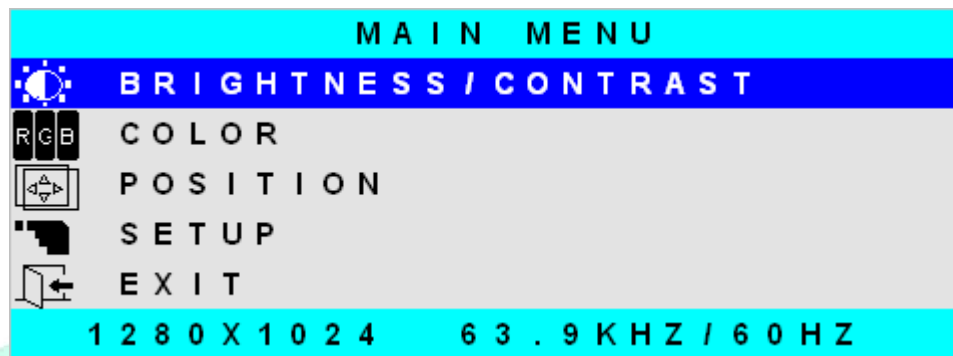

- BRIGHTNESS/CONTRAST: Increase/decrease panel brightness level, total: 100 steps
- COLOR: Color Temperature control, RED/GEEN/BLUE total: 100 steps
- POSITIPON
  - HORIZONTAL: Image H position control, total: 100 steps
  - VERTICAL: V position control, total: 100 steps
  - CLCOK: Fine tune the number of sampled data.
  - PHASE: Fine tune the position of sampled data (adjust image quality), total: 31 steps
- SETUP
  - OSD POSTION : 5
  - OSD TIME : 5 to 60 seconds
  - INPUT SOURCE : ANALOG, DIGITAL, COMPOSITE, S-VIDEO
  - EXIT

**OSD FUNCTION**

**BRIGHTNESS / CONTRAST Control**

**1) Menu**

**2) Select**

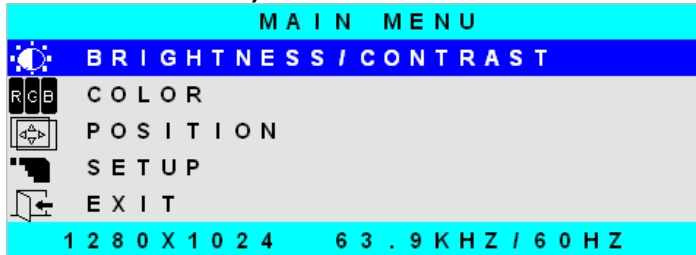

**Brightness**

**Procedure**

Menu > BRIGHTNESS/CONTRAST (Blue Highlight) > Select



▼ Dark

▲ Bright

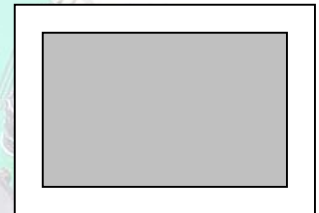
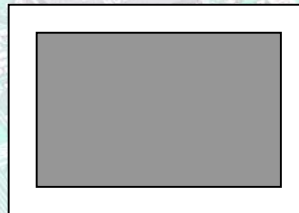

**Contrast**

**Procedure**

Menu (Blue Highlight) > Select



▼ Distinctive

▲ Vague

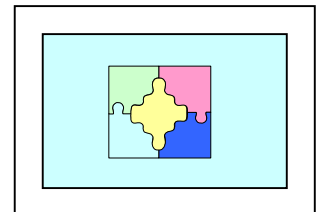
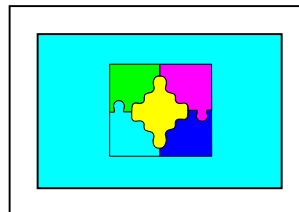



**COLOR Control**

**1) Menu & Down**

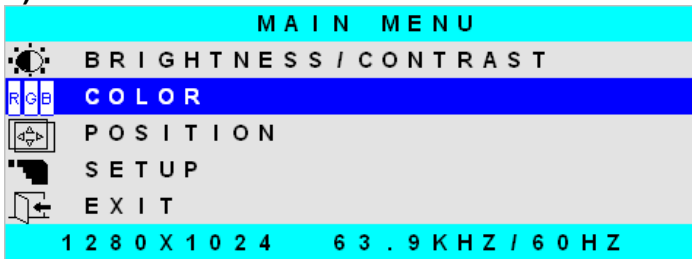

**2) Select**

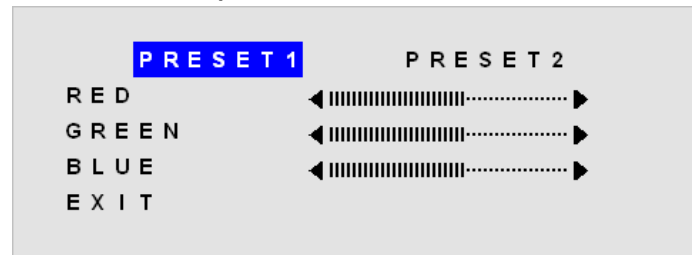

Preset 1: Default

Preset 2: bluish white

RED/GREEN/BLUE : User Color Control

**Color (PC Input Mode)**

**Procedure** Menu > Color (Blue Highlight) >

Select



- Select (Blue Highlight) > RED Color Control (select return to Left Status)
- Select (Blue Highlight) > GREEN Color Control

**Color (VIDEO Input Mode)**

**Procedure** Menu > Color (Blue Highlight) >

Select

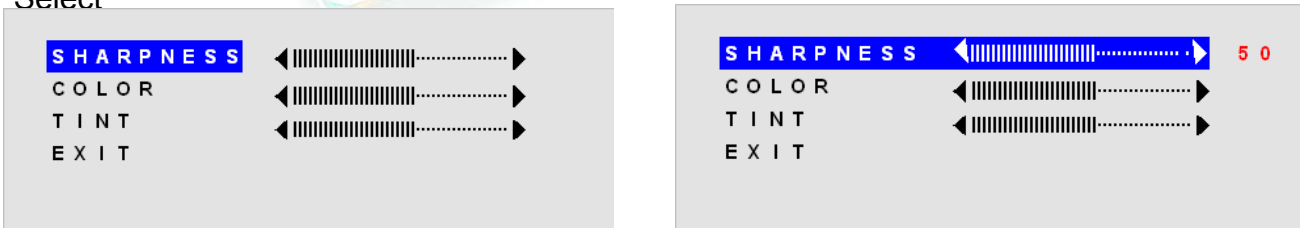

- Select (Blue Highlight) > SHARPNESS (select return to Left Status)
  - SHARPNESS : Focus of Image
  - COLOR : Thickness of Color
  - TINT : Tone of Image

**POSITION Control**

**1) Menu & Down**

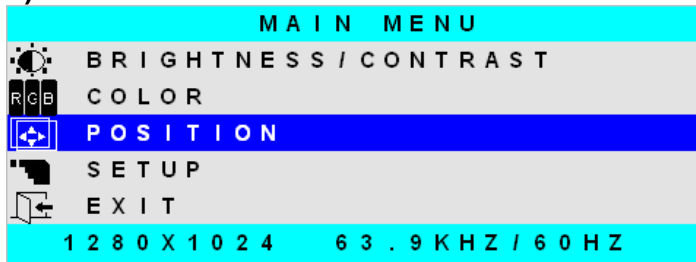

**2) Select**

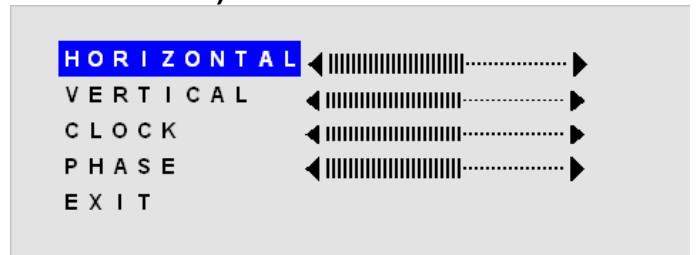

**HORIZONTAL Position**

**Procedure** Menu > POSITION > HORIZONTAL > select

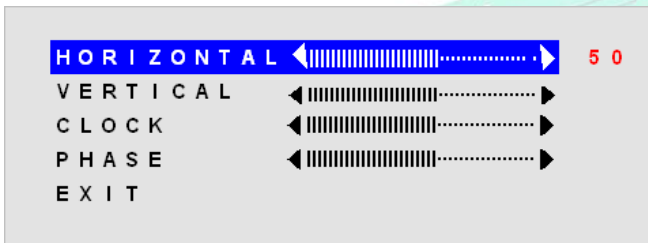

When display image is out of screen, can adjust with this function for getting Optimized Image)

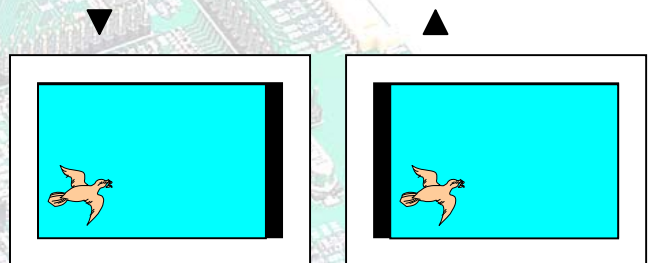

**VERTICAL Position**

**Procedure** POSITION > VERTICAL > select

When display image is out of screen, can adjust with this function for getting Optimized Image)

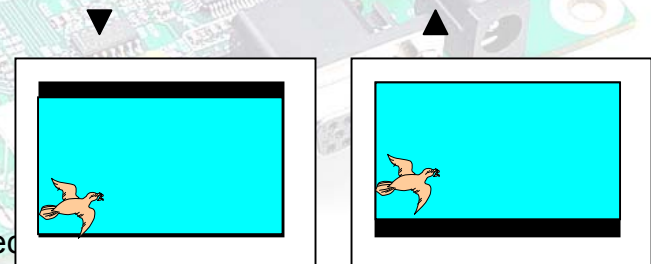

Mismatch

Optimized

**CLOCK**

**Procedure** POSITION > CLCOK > select

When display image is wrinkled, can adjust with this function for getting Optimized Image)

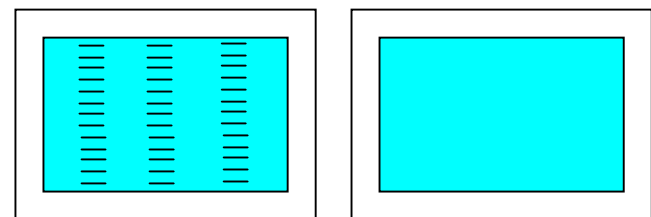

Mismatch

Optimized

**Phase**

**Procedure** POSITION > Phase select

When display image is vague, can adjust with this function for getting Optimized Image)

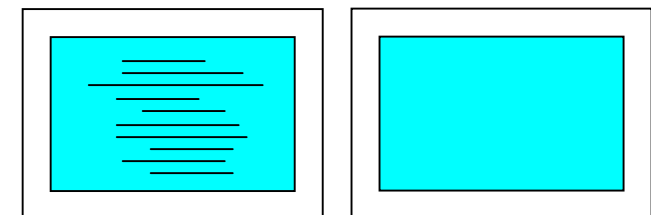

**SETUP Control**

**1) Menu & Down**

**2) Select**

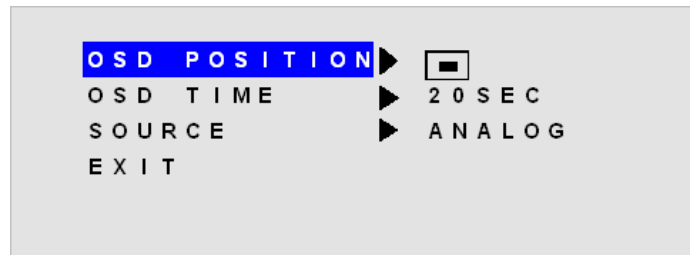
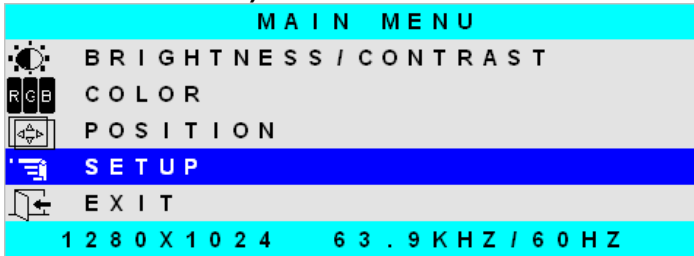

**OSD POSITION Function**

**Procedure**      SETUP > OSD POSITION > Select

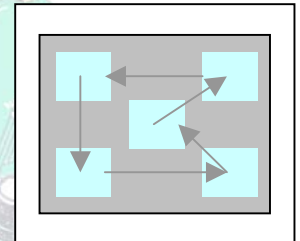
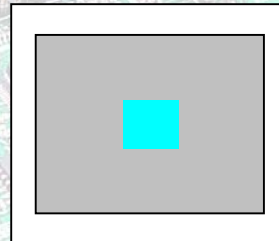
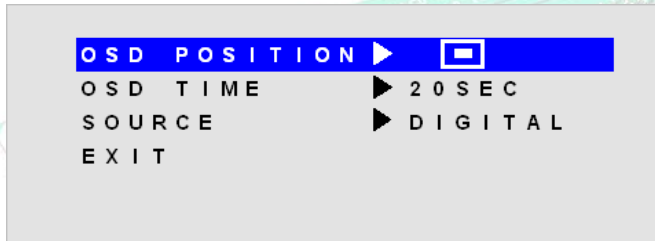

**OSD POSITION Function**

**Procedure**      SETUP > OSD TIME > Select

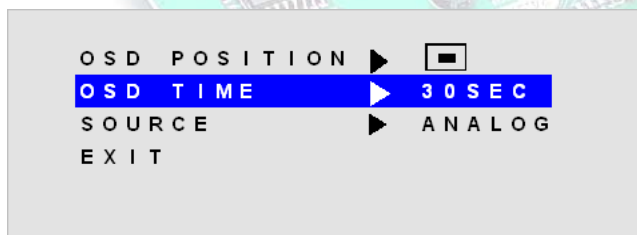

10 to 60 Sec

**SOURCE Select Function**

**Procedure**      SETUP > SOUREC > Select

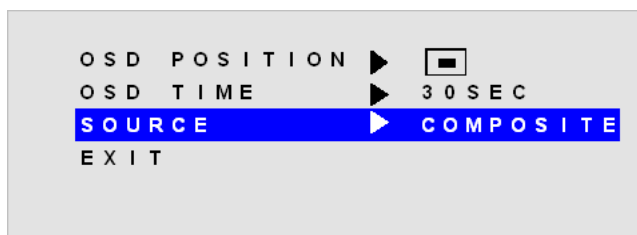

ANALOG -> DIGITAL ->  
COMPOSITE -> SVIDEO  
-> ANALOG -> DIGITAL .....

**Operation Message**

**OUT OF FREQUENCY**

Input Signal is over the supporting range

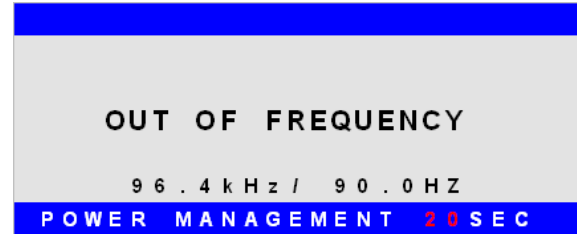

**POWER SAVER MODE**

Input Signal is not present. This message is disappeared after 5 seconds.



**SELF DIAGNOSTICS**

Input Signal is not present after power on with power switch. This message is not disappeared before power off or activity of input signal.



**AUTO CONFIGURATION**

Execute AUTO Function.

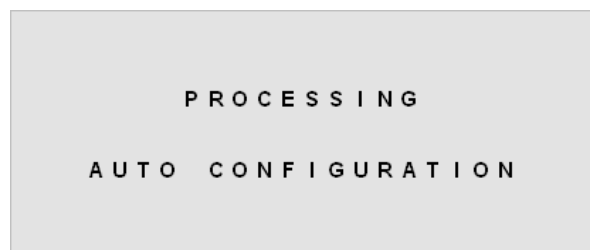

## CONNECTOR, PINOUT & JUMPERS

The various connectors are:

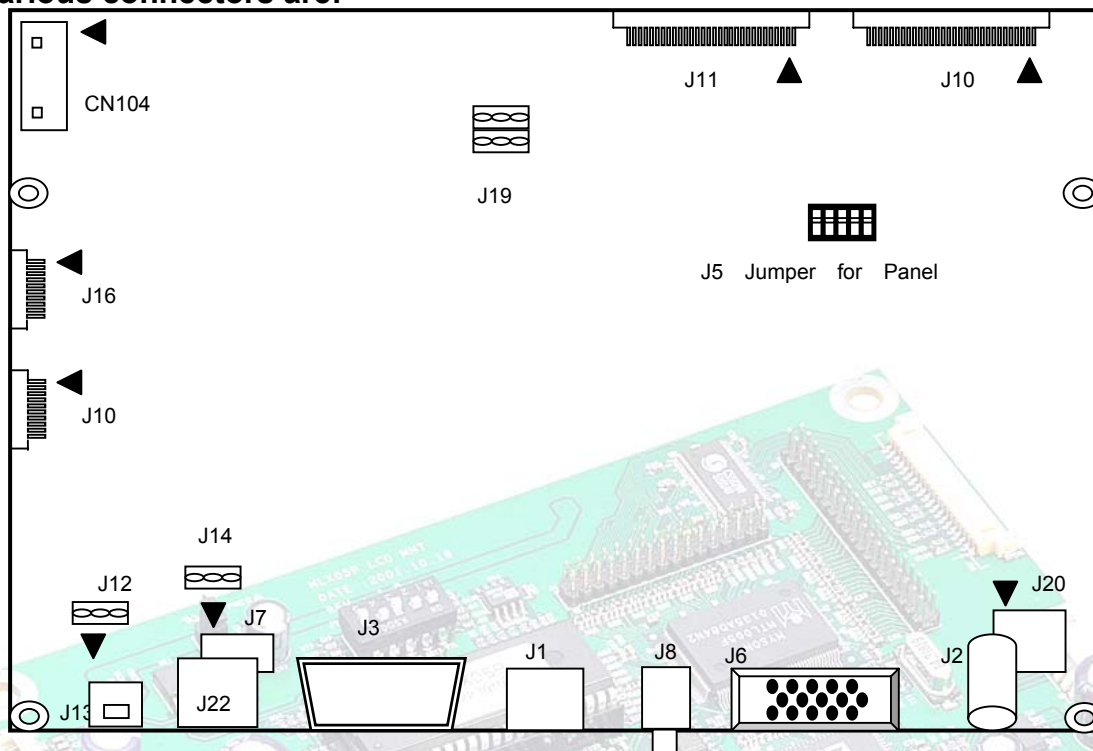

### Summary

Reference	Item	Description	Type	Manufacture
J1	Jack	S-video Input	MJ373	MINIDIN 3PIN
CN104	Connector	To OSD Board	53015-0710	MOLEX
J22	Connector	Input Dc power Jack	KPJ-4S-S	KYCON
J6	Connector	Analog RGB Input	15P D-SUB	-
J11	Connector	LVDS 2 channel LCD interface	12505WR-30	YEONHO
J8	Connector	C-video Input	RCA(Yellow)	-
J100	Connector	LVDS 1 channel LCD interface	12505WR-20	YEONHO
J2	Jack	Input Dc power Jack	2.5Ø	-
J10, J16	Connector	Inverter Connector	53261-1090	MOLEX
J12	Connector	Output Power Jumper	HDR3X1	2.54mm
J13	Connector	Output Power	53015-0310	MOLEX
J14	Jumper	Inverter Power Jumper	HDR3X1	2.54mm
J19	Jumper	Panel Power Jumper	HDR3X1	2.54mm

J7	Connector	12/18V power Input Connector	53015-0410	MOLEX
J20	Connector	24V power Input Connector	53015-0410	MOLEX

**J1: S-Video Input Jack**

Pin No.	Symbol	Description
1	GND	Ground
2	GND	Ground
3	C-in	CROMA signal input
4	Y-in	LUMA signal input
5	GND	Ground
6	GND	Ground
7	GND	Ground

**CN104: OSD control connector**

Pin No.	Symbol	Description
1	Vcc	+5V power for IR sensor
2	IRQ	Infrared rays signal line.
3	LED2	RED LED
4	LED1	GREEN LED
5	GND	Ground
6	KEY1	Up, Power
7	KEY0	Menu, Select, Down

**J22: +24V DC power supply**

Pin No	Symbol	Description
1 2	Vcc	24V
3 4	GND	Ground

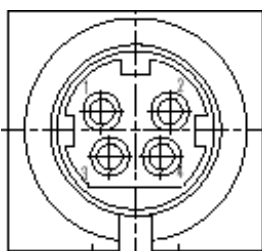
**J7: DC power Input Connector**

Pin No.	Symbol	Description
1,2	Vcc	24V
3,4	GND	Ground

**J6: ANALOG VGA INPUT**

Pin No.	Symbol	Description
1	Red1	Red analog input
2	Green1	Green analog input
3	Blue1	Blue analog input
4,5,6,7,8	GND	Ground
9	NC	Not connected
10,11	GND	Ground
12	DSDA	DDC-SDA
13	HSYNC	Horizontal Sync
14	VSYNC	Vertical Sync
15	DSCL	Serial Clock Input

**J3: DVI-D Input Connector**

Pin No.	Symbol	Description
1	TMDS DATA2-	TMDS DATA2 Differential Negative Signal
2	TMDS DATA2+	TMDS DATA2 Differential Positive Signal
3	TMDS DATA2 Shield	Shield for TMDS Channel #2
4,5	NC	No Connection
6	DDC Clock	The Data Line for the DDC Interface
7	DDC Data	The Clock Line for the DDC Interface
8	NC	No Connection
9	TMDS DATA1-	TMDS DATA1 Differential Negative Signal
10	TMDS DATA1+	TMDS DATA1 Differential Positive Signal
11	TMDS DATA1 Shield	Shield for TMDS Channel #1
12,13	NC	No Connection
14	+5V Power	+5 Volt signal for EDID (Un-powered Monitor)
15	GND(for +5V)	Ground for +5 Volt Power pin, Sync return
16	HPD	Identify the presence of a monitor
17	TMDS DATA0-	TMDS DATA0 Differential Negative Signal
18	TMDS DATA0+	TMDS DATA0 Differential Positive Signal
19	TMDS DATA0 Shield	Shield for TMDS Channel #0
20,21	NC	No Connection
22	TMDS CLOCK Shield	Shield for TMDS Clock differential Pair
23	TMDS CLOCK+	TMDS DATA0 Differential Positive Signal
24	TMDS CLOCK-	TMDS DATA0 Differential Negative Signal

**J8: C-video jack**

Pin No.	Symbol	Description
1,2	Composite	CVBS input signal
3	GND	Ground

**J2: +12V/18V DC power supply**

Pin No	Symbol	Description
1	12V	Main power for controller (12V/18V)
2	GND	Ground
3	GND	Ground



**J10, 16: Backlight Inverter connector**

Pin No.	Symbol	Description		
1	DIM-ADJ	DIM-adjustment analog dimming control signal * make sure inverter specification		
		Panel	Min	Max
		LM171W01	3.3V	0V
		LC171W03	3.3V	0V
		LM201U03	3.3V	0V
		LCM300W01	-	5V
2	ON/OFF	Inverter digital ON(3.3V)/OFF(0V) signal		
3,4,5,6	GND	Ground		
7,8,9,10	B+	B+(24V or 12/18V)		

**J20: DC power Input Connector**

Pin No.	Symbol	Description
1,2	Vcc	12V
3,4	GND	Ground

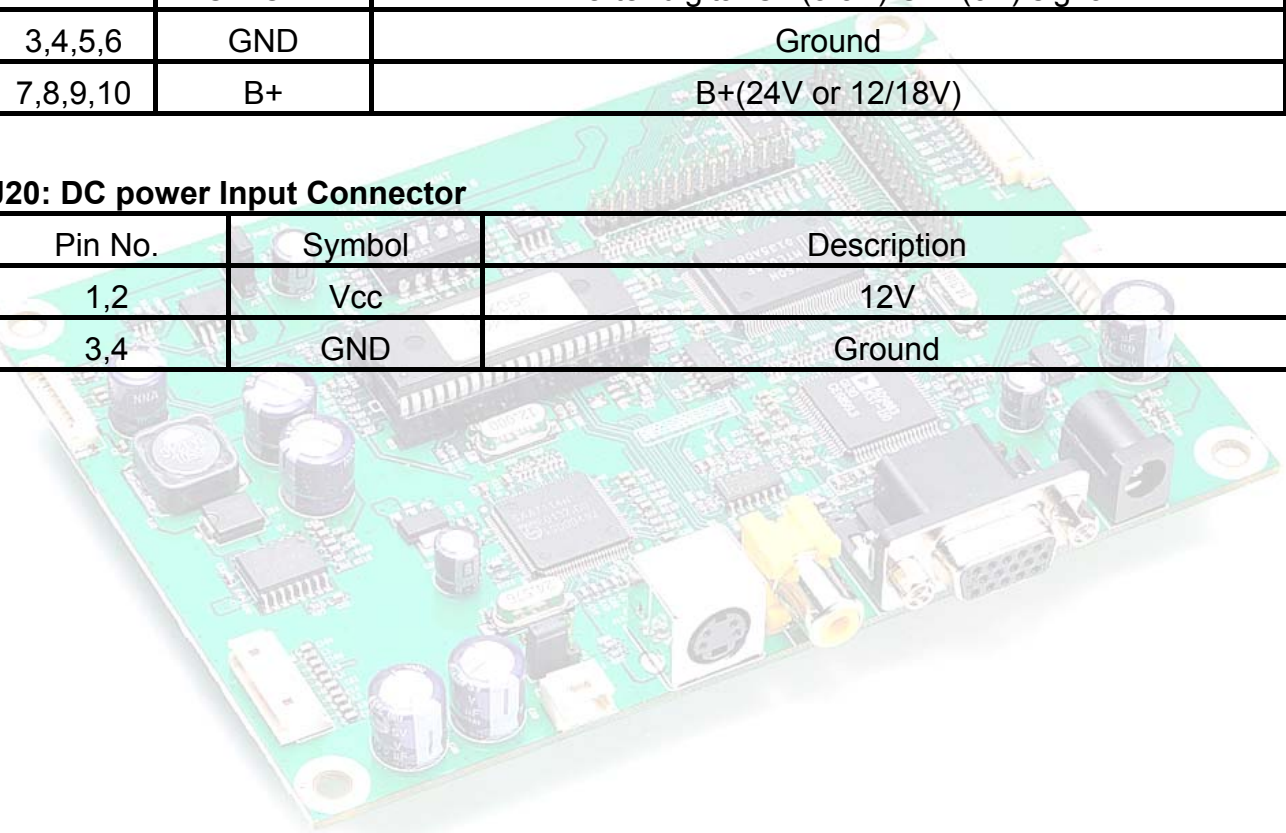

**J11: LCD Interface connector for 2 Ch LVDS type**

Pin No.	Symbol	Description
1	MOD_PWR	Panel Power (12V/18V, 5V or 3.3V)
2	MOD_PWR	Panel Power (12V/18V, 5V or 3.3V)
3	MOD_PWR	Panel Power (12V/18V, 5V or 3.3V)
4	MOD_PWR	Panel Power (12V/18V, 5V or 3.3V)
5	GND	Ground
6	SELLDS	LVDS DATA ORDER SELECT(Depends on Panel)/ No Connection
7	GND	Ground
8	Y3P-EVEN	Positive(+) LVDS differential first 3 data(A port)
9	Y3M-EVEN	Negative(-) LVDS differential first 3 data(A port)
10	YCP-EVEN	Positive(+) LVDS differential first Clock(A port)
11	YCM-EVEN	Negative(-) LVDS differential first Clock(A port)
12	Y2P-EVEN	Positive(+) LVDS differential first 2 data(A port)
13	Y2M-EVEN	Negative(-) LVDS differential first 2 data(A port)
14	GND	Ground
15	Y1P-EVEN	Positive(+) LVDS differential first 1 data(A port)
16	Y1M-EVEN	Negative(-) LVDS differential first 1 data(A port)
17	YOP-EVEN	Positive(+) LVDS differential first 0 data(A port)
18	Y0M-EVEN	Negative(-) LVDS differential first 0 data(A port)
19	GND	Ground
20	Y3P-ODD	Positive(+) LVDS differential second 3 data(B port)
21	Y3M-ODD	Negative(-) LVDS differential second 3 data(B port)
22	YCP-ODD	Positive(+) LVDS differential second Clock(B port)
23	YCM-ODD	Negative(-) LVDS differential second Clock(B port)
24	Y2P-ODD	Positive(+) LVDS differential second 2 data(B port)
25	Y2M-ODD	Negative(-) LVDS differential second 2 data(B port)
26	GND	Ground
27	Y1P-ODD	Positive(+) LVDS differential second 1 data(B port)
28	Y1M-ODD	Negative(-) LVDS differential second 1 data(B port)
29	YOP-ODD	Positive(+) LVDS differential second 0 data(B port)
30	Y0M-ODD	Negative(-) LVDS differential second 0 data(B port)

**J100: LCD Interface connector for 1 Ch LVDS type**

Pin No.	Symbol	Description
1	GND	Ground
2	GND	Ground
3	Y3P	LVDS 3 Channel Positive Signal for LCD Module (6Bit Unused)
4	Y3M	LVDS 3 Channel Negative Signal for LCD Module (6Bit Unused)
5	GND	Ground
6	CLKOUTP	LVDS Clock Positive Signal of Channel for LCD Module
7	CLKOUTM	LVDS Clock Negative Signal of Channel for LCD Module
8	GND	Ground
9	Y2P	LVDS 2 Channel Positive Signal for LCD Module
10	Y2M	LVDS 2 Channel Negative Signal for LCD Module
11	GND	Ground
12	Y1P	LVDS 1 Channel Positive Signal for LCD Module
13	Y1M	LVDS 1 Channel Negative Signal for LCD Module
14	GND	Ground
15	Y0P	LVDS 0 Channel Positive Signal for LCD Module
16	Y0M	LVDS 0 Channel Negative Signal for LCD Module
17	GND	Ground
18	GND	Ground
19	MOD_PWR	VDD For LCD Module(12V/18V, 5V or 3.3V)
20	MOD_PWR	VDD For LCD Module(12V/18V, 5V or 3.3V)

**J12: On board Power Supply jumper for J12**

Pin No.	Symbol	Description
1	CTRL	POWER CONTROL FOR LCD
2,3,4	GND	Ground
5,6,7	VCC	12V/18V

**J13: Power out connector**

Pin No.	Symbol	Description
1	Vcc	5V or 12V/18V Inverter power selected by J12' Jumper
2	GND	Ground
3	GND	Ground

**J14: On board +24V/+12V Inverter power select jumper**

Pin No.	Symbol	Description
1	12V	representative 12V/18V, depends on power supply from J2
2	B+	Inverter power selected by J14' Jumper
3	24V	24V from J22

**J19: LCD Panel power select jumper**

Pin No.	Symbol	Description
1	3.3V	3.3V
2	5V	5V
3	12V	representative 12V/18V, depends on power supply
4,5,6	MOD_PWR	Panel Power (12V/18V, 5V or 3.3V) selected by jumper

\* Refer to silk on PCB as jumper setting guide.

**Summary: jumpers setting**

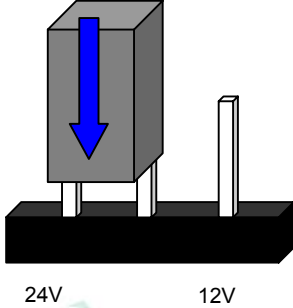
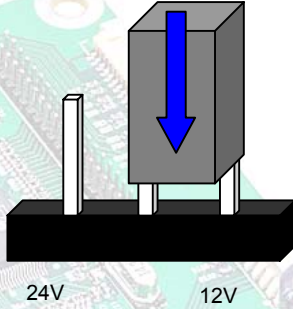
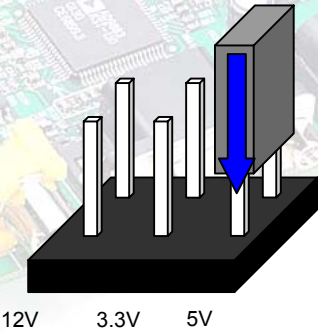
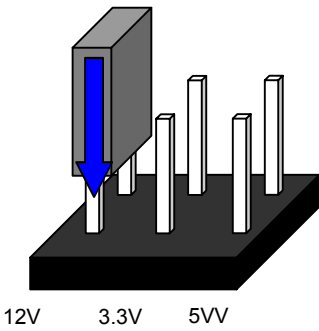
Reference	Description	Connector Type
J14	+24V inverter power enable	
	+12/18V inverter power enable	
J19	5.0V panel power <b>CAUTION:</b> Incorrect setting can damage panel	
	12V/18V panel power <b>CAUTION:</b> Incorrect setting can damage panel	

**\* Power operation scheme :**

- 24V power supply from J22, 12V power generated by DC/DC converter so all 12V as marked 12V
- 12V or 18V from J2, marked 12V is representative 12V or 18V as well as power supply

**CONTROLLER DIMENSIONS**

Mounting Hole position will be changed next version.

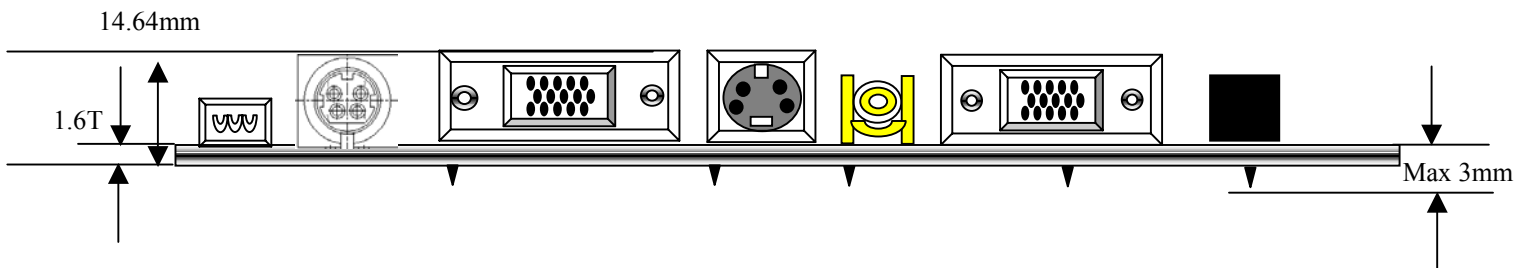
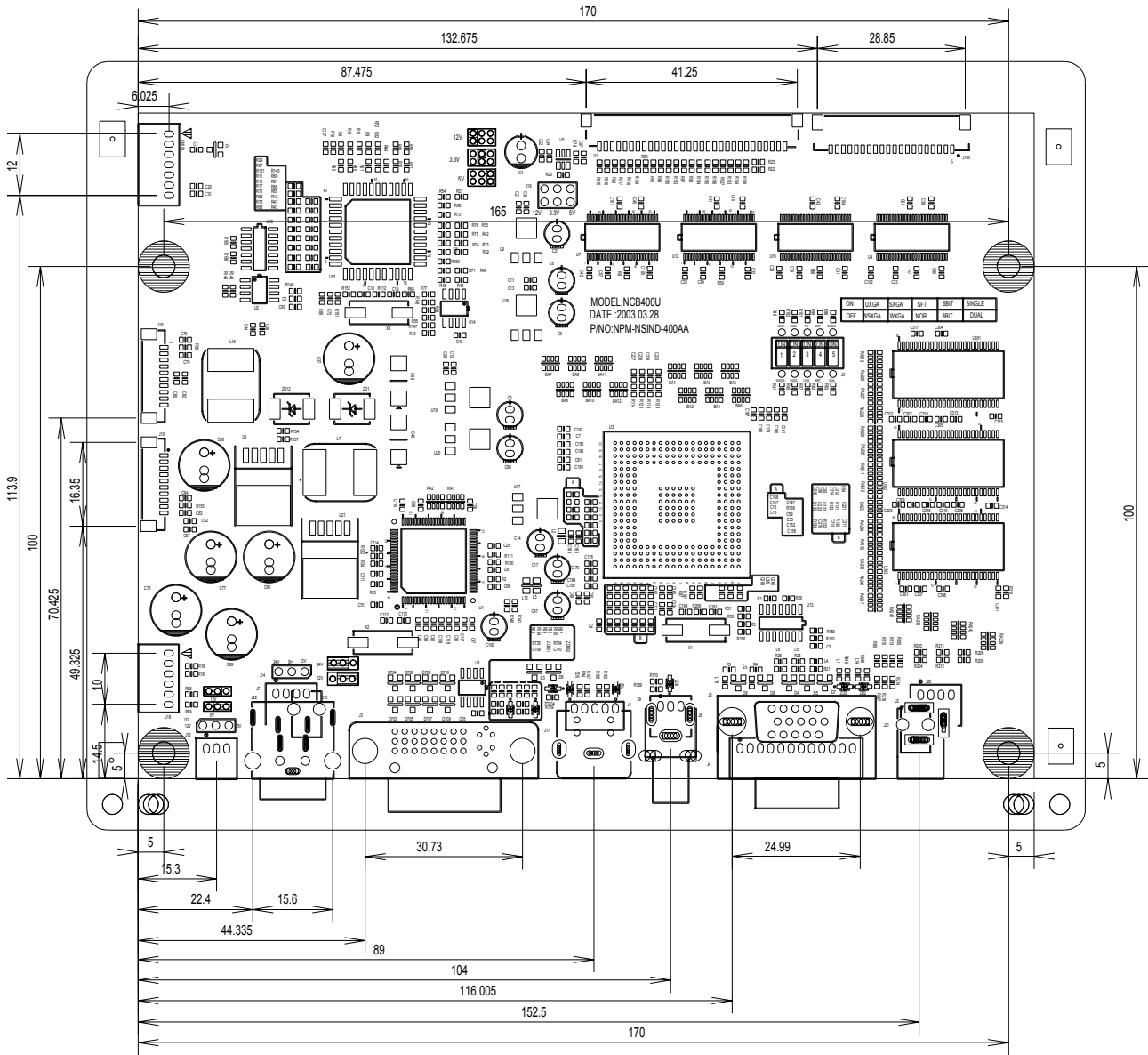

## **APPLICATION NOTES**

### **USING THE CONTROLLER WITHOUT BUTTONS ATTACHED**

**This is very straightforward:**

- Firstly setup the controller/display system with the buttons. With the attached controllers and display system active make any settings for color, contrast and image position as required then switch everything off.
- Remove the control switches, the 7-way cable.
- Refer to inverter specifications for details as to fixing brightness to a desired level, this may require a resistor, an open circuit or closed circuit depending on inverter

### **INVERTER CONNECTION**

There are 3 potential issues to consider with inverter connection:

- Power
- ON/OFF
- Brightness (DIM-ADJ)

**Inverter power:** This should be matched with the inverter specification.

**Inverter ON/OFF:** This is a pin provided on some inverter for ON/OFF function and is used by this panel controller for VESA DPMS compliance. If the inverter does not have on/off pin or the on/off pin is not used DPMS will not operate. Pin 5 should be matched to the inverter specification for the ON/OFF pin.

**Brightness Dimming control:** NCB400 controller boards are analog dimming control method. And it is important to consider the specifications for the inverter to be used.

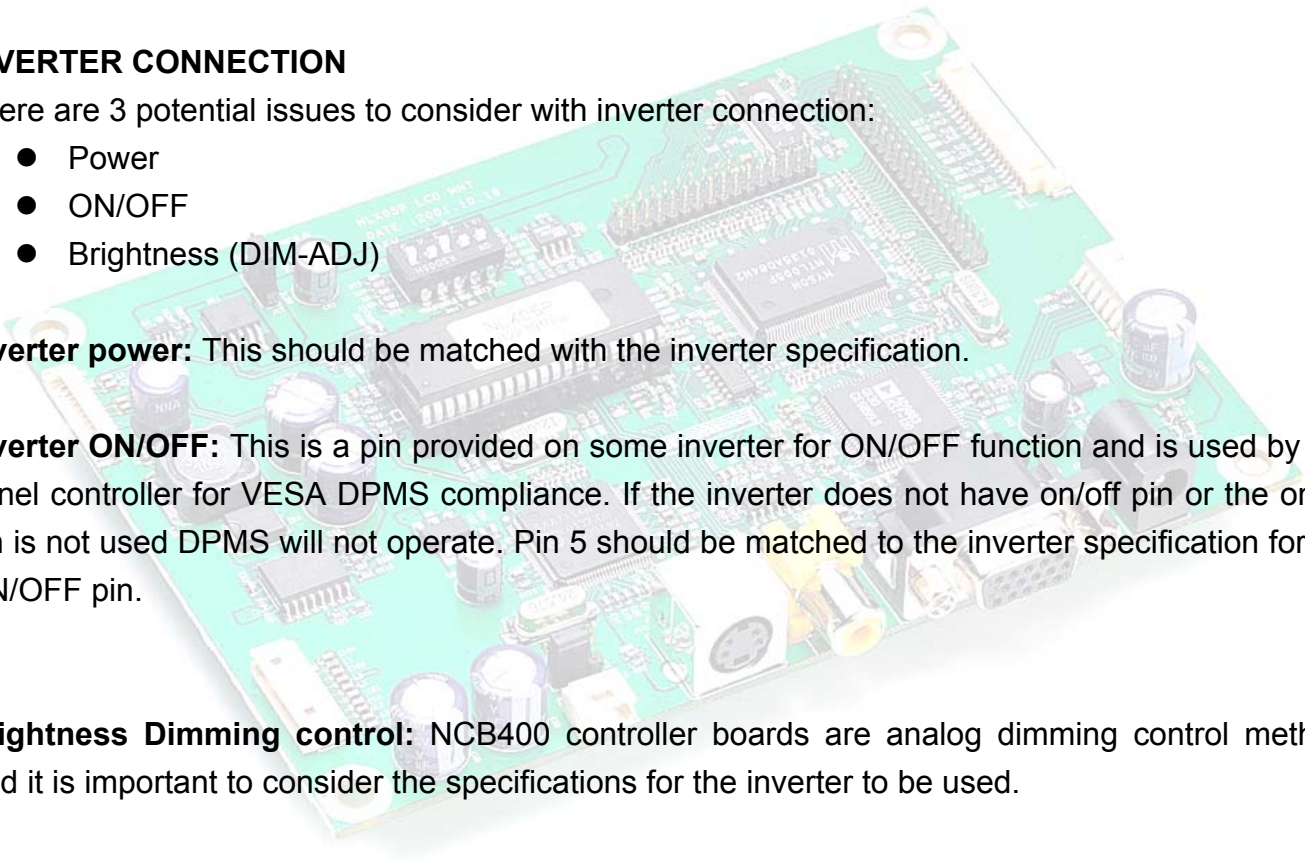

## **TROUBLESHOOTING**

### **General**

A general guide to troubleshooting of a flat panel display system it worth considering the system as separate elements, such as:

- ▶ Controller (jumpers, PC settings)
- ▶ Panel (controller, cabling, connection, panel, PC settings)
- ▶ Backlight (inverter, cabling, connection, panel, Pc settings)
- ▶ Cabling
- ▶ Computer system (display settings, operating system)

Through checking the system step by step cross with instruction manuals and a process of elimination to isolate the problem it is usually possible to clearly identify the problem area.

### **No image:**

- ▶ If the panel backlight is not working it may still be possible to see just some image.
- ▶ A lack of image is most likely to be caused by incorrect connection, lack of power, failure to provide a signal or incorrect graphic card settings.

### **Image position:**

If it is impossible to position the image correctly, the image adjustment controls will not move the image far enough, then test using another graphics card. This situation can occur when a graphic card is not close to standard timing or when something is in the graphics line that may affect the signal such as a signal splitter (please note that normally a signal splitter will not have any adverse effect).

### **Image appearance:**

- ▶ A faulty panel can have blank lines, failed sections, flickering or flashing display.
- ▶ Incorrect graphic card refresh rate, resolution or interlaced mode will probably cause the image to be the wrong size, to scroll to, flicker badly or possibly even no image.
- ▶ Incorrect jumper settings on the controller may cause everything from incorrect image viewing to total failure.

**CAUTION:** Do not set the panel power input incorrectly.

- ▶ Sparkling on the display: faulty panel signal cable.

### **Backlight:**

Items to check include: Power input, controls, inverter and Tubes generally in this order.

If half the screen is dimmer than the other half:

- ▶ Check cabling for the inverter.

Also:

- ▶ If system does not power down when there is a loss of signal.



### APPLICABLE GRAPHIC MODE

The microprocessor measures the, H – sync V – sync and polarity for RGB Inputs, and uses this timing information to control all of the display operation to get the proper image on a screen. This board can detect all VESA standard Graphic modes shown on the table below and Provide more clear and stable image on a screen

**Table 6.1) RGB input format**

Spec Mode	Pixel Freq.	Horizontal Timing				Vertical Timing			
		Sync Polar	Freq.	Total	Active	Sync Polar	Freq.	Total	Active
	MHz		KHz	Pixel	Pixel		Hz	Line	Line
640*350@70Hz	25.144	P	31.430	800	640	N	70.000	449	350
640*400@70Hz	28.287	N	31.430	800	640	P	70.000	449	400
720*400@ 70Hz	28.287	N	31.430	900	720	P	70.000	449	400
640*480@60Hz	28.175	N	31.469	800	640	N	59.940	525	480
640*480@72Hz	31.500	N	37.861	832	640	N	72.809	520	480
640*480@75Hz	31.500	N	37.500	840	640	N	75.000	500	480
800*600@56 Hz	36.000	P	35.156	1024	800	P	56.250	625	600
800*600@60Hz	40.000	P	37.879	1056	800	P	60.317	628	600
800*600@72Hz	50.000	P	48.077	1040	800	P	72.188	666	600
800*600@75Hz	49.500	P	46.875	1056	800	P	75.000	625	600
1024*768@60Hz	65.000	N	48.363	1344	1024	N	60.005	806	768
1024*768@70Hz	75.000	N	56.476	1328	1024	P	70.070	806	768
1024*768@75Hz	78.750	P	60.023	1312	1024	P	75.030	800	768
1280*768@60Hz	TBD								
1280*1024@60Hz	108.000	P	63.981	1688	1280	P	60.020	1066	1024
1280*1024@75Hz	135.000	P	79.976	1688	1280	P	75.035	1066	1024
1600*1200@60Hz	162.000	P	75.000	2160	1600	P	60.000	1250	1200

\* Above mode is depends on controller board

**ACCESSORY**

This board requires several accessories to build a complete display unit. **KORDIS** can provide standard accessory for this board as below through sales representative.

No.	Items	Part No.	Ex) LG. Philips LM171W01
1	LCD signal cable	SC-Panel Part No.-mm	SC-LC151X01-30
2	Inverter	Part no. of Manufacturer	GH053A
3	Inverter cable	IC-Panel Part No.-mm	IC-GHJ053A-30
4	OSD Board	NLX05-OSD	NLX05-OSD
5	OSD Cable	OC-NID01-mm	OC-NID01-20

- \* **SC:** LCD Signal Cable
- IC:** Inverter Interface cable
- OC:** OSD Board cable
- mm: Cable length(unit: mm)

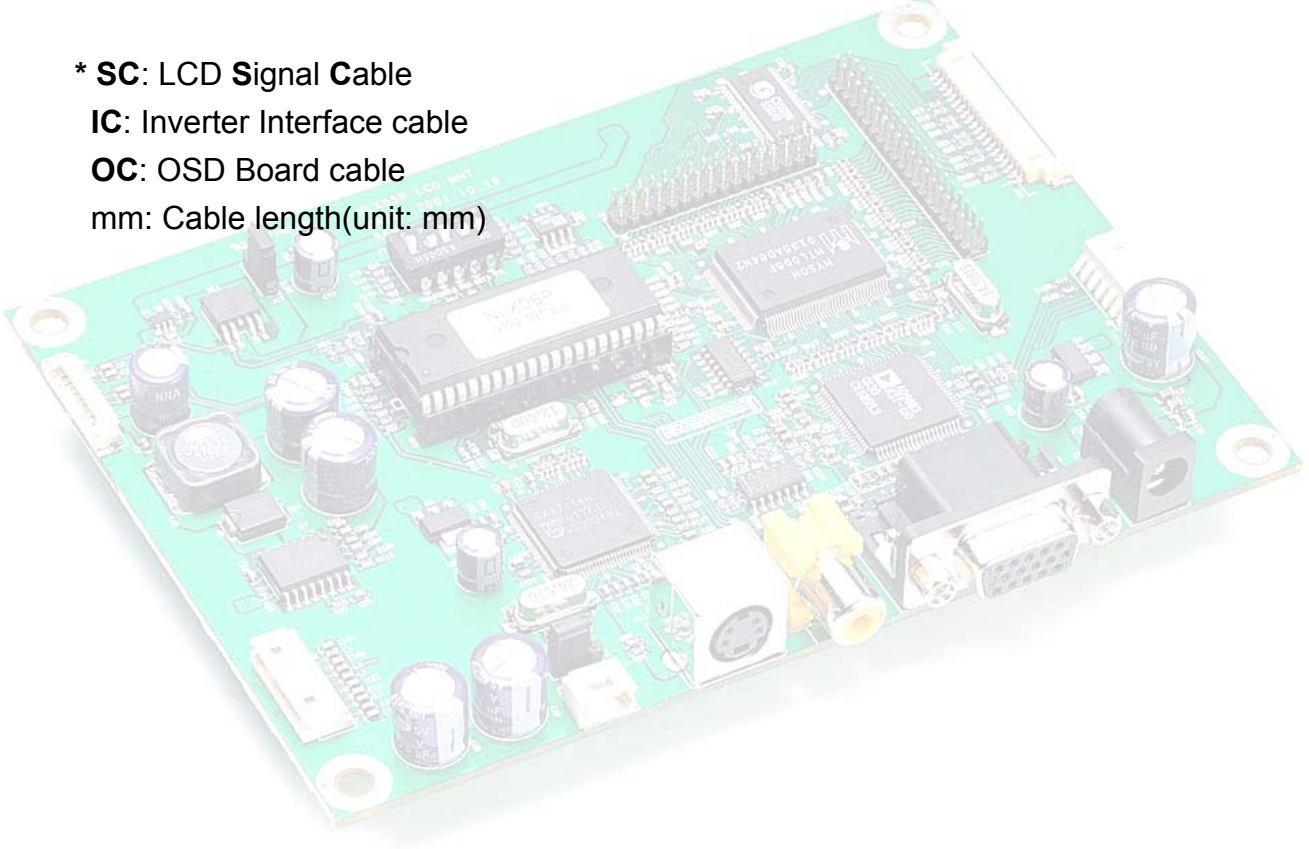

**APPENDIX**

**A. Supporting panel & Ordering Information**

This board can support various LCD panels, which have WXGA and UXGA resolution.

The table below shows the model names of LCD panel, LCD panel selection and the dedicated inverter for each LCD panel. And KORDIS will try continuously to the model names of the LCD panels that have been tested.

No.	LCD panel Model Name	LCD vendor	Ordering Part Number of Controller
1	LC171W03	LG Philips	NCB400W4
2	LM171W01	LG Philips	NCB400W4
3	LC300W01	LG Philips	NCB400W4
4	LM201U03	LG Philips	NCB400U4

**B. Tested panel**

This board can support various LCD panels, which have WXGA and UXGA resolution.

The table below shows the model names of LCD panel, Jumper setting for LCD power, LCD panel selection and the dedicated inverter for each LCD panel. All of the LCD Panels listed can work without changing the control program of the NCB400 board. And KORDIS will try continuously to the model names of the LCD panels that have been tested.

No.	LCD P/NO	LCD vendor	LCD VCC	Option (note1)	J5				
					SW1	SW2	SW3	SW4	SW5
1	LM171W01	LG Philips LCD	+5.0V	WXN8S	OFF	OFF	OFF	OFF	OFF
2	LC171W03	LG Philips LCD	+12.0V	WXN8S	OFF	OFF	OFF	OFF	OFF
3	LM201U03	LG Philips LCD	+18.0V	UXN8D	OFF	OFF	OFF	OFF	OFF
4	LCM300W01	LG Philips LCD	+12.0V	WXS8S	OFF	OFF	ON	OFF	OFF

Note1 : Abbreviated word : U<sup>Ⓐ</sup>S<sup>Ⓑ</sup>6<sup>Ⓒ</sup>S<sup>Ⓓ</sup>

- Ⓐ UX/WS/SX/WX : UX UXGA, WS WSXGA, SX SXGA, WX WXGA
- Ⓑ S/N : S(SFT) SHIFT, N(NOR) NORMAL
- Ⓒ 6/8 : 6 6BITS 8 8BITS
- Ⓓ S/D : SINGLE PORT, D DUAL PORT