

## DESCRIPTION

The SSF2302 uses advanced trench technology to provide excellent  $R_{DS(ON)}$ , low gate charge and operation with gate voltages as low as 2.5V. This device is suitable for use as a Battery protection or in other Switching application.

## GENERAL FEATURES

- $V_{DS} = 20V, I_D = 2.4A$   
 $R_{DS(ON)} < 115m\Omega @ V_{GS}=2.5V$   
 $R_{DS(ON)} < 60m\Omega @ V_{GS}=4.5V$
- High Power and current handling capability
- Lead free product is acquired
- Surface Mount Package

## Application

- Battery protection
- Load switch
- Power management

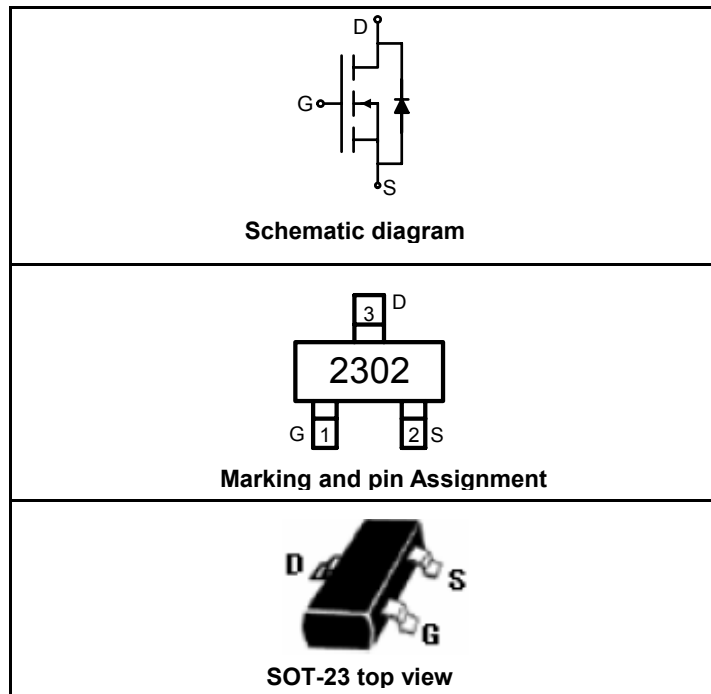

## PACKAGE MARKING AND ORDERING INFORMATION

Device Marking	Device	Device Package	Reel Size	Tape width	Quantity
2302	SSF2302	SOT-23	Ø180mm	8 mm	3000 units

## ABSOLUTE MAXIMUM RATINGS(TA=25°C unless otherwise noted)

Parameter	Symbol	Limit	Unit
Drain-Source Voltage	$V_{DS}$	20	V
Gate-Source Voltage	$V_{GS}$	±8	V
Drain Current-Continuous@ Current-Pulsed (Note 1)	$I_D (25^\circ C)$	2.4	A
	$I_D (70^\circ C)$	1.7	A
	$I_{DM}$	10	A
Maximum Power Dissipation	$P_D$	0.9	W
Operating Junction and Storage Temperature Range	$T_J, T_{STG}$	-55 To 150	°C

## THERMAL CHARACTERISTICS

Thermal Resistance, Junction-to-Ambient (Note 2)	$R_{\theta JA}$	140	°C/W
--	-----------------	-----	------

## ELECTRICAL CHARACTERISTICS (TA=25°C unless otherwise noted)

Parameter	Symbol	Condition	Min	Typ	Max	Unit
<b>OFF CHARACTERISTICS</b>						
Drain-Source Breakdown Voltage	$BV_{DSS}$	$V_{GS}=0V, I_D=250\mu A$	20			V
Zero Gate Voltage Drain Current	$I_{DSS}$	$V_{DS}=20V, V_{GS}=0V$			1	µA
Gate-Body Leakage Current	$I_{GSS}$	$V_{GS}=\pm 8V, V_{DS}=0V$			±100	nA
<b>ON CHARACTERISTICS (Note 3)</b>						
Gate Threshold Voltage	$V_{GS(th)}$	$V_{DS}=V_{GS}, I_D=250\mu A$	0.65	0.95	1.2	V

Drain-Source On-State Resistance	$R_{DS(ON)}$	$V_{GS}=2.5V, I_D=3.1A$	70	115	m $\Omega$
		$V_{GS}=4.5V, I_D=3.6A$	45	60	m $\Omega$
Forward Transconductance	$g_{FS}$	$V_{DS}=5V, I_D=3.6A$	8		S
<b>DYNAMIC CHARACTERISTICS (Note4)</b>					
Input Capacitance	$C_{ISS}$	$V_{DS}=10V, V_{GS}=0V,$ $F=1.0MHz$	300		PF
Output Capacitance	$C_{OSS}$		120		PF
Reverse Transfer Capacitance	$C_{RSS}$		80		PF
<b>SWITCHING CHARACTERISTICS (Note 4)</b>					
Turn-on Delay Time	$t_{d(on)}$	$V_{DD}=10V, R_L = 2.8 \Omega$ $V_{GS}=4.5V, R_{GEN}=6\Omega,$ $I_D=3.6A,$	7	15	nS
Turn-on Rise Time	$t_r$		55	80	nS
Turn-Off Delay Time	$t_{d(off)}$		16	60	nS
Turn-Off Fall Time	$t_f$		10	25	nS
Total Gate Charge	$Q_g$	$V_{DS}=10V, I_D=3.6A, V_{GS}=4.5V$	4.0	10	nC
Gate-Source Charge	$Q_{gs}$		0.65		nC
Gate-Drain Charge	$Q_{gd}$		1.5		nC
<b>DRAIN-SOURCE DIODE CHARACTERISTICS</b>					
Diode Forward Voltage (Note 3)	$V_{SD}$	$V_{GS}=0V, I_S=0.94A$	0.76	1.2	V
Diode Forward Current (Note 2)	$I_S$		0.94		A

## NOTES:

1. Repetitive Rating: Pulse width limited by maximum junction temperature.
2. Surface Mounted on 1in<sup>2</sup> FR4 Board,  $t \leq 10$  sec.
3. Pulse Test: Pulse Width  $\leq 300\mu s$ , Duty Cycle  $\leq 2\%$ .
4. Guaranteed by design, not subject to production testing.

## TYPICAL ELECTRICAL AND THERMAL CHARACTERISTICS

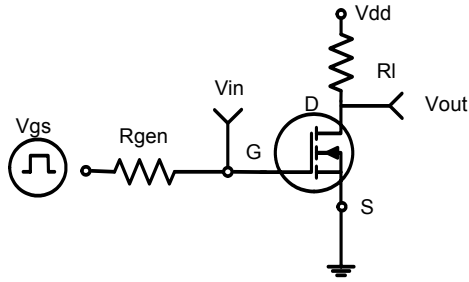

Figure 1: Switching Test Circuit

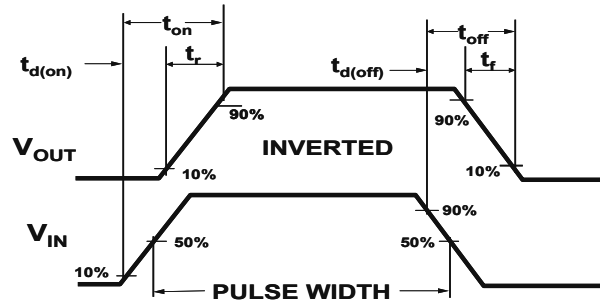

Figure 2: Switching Waveforms

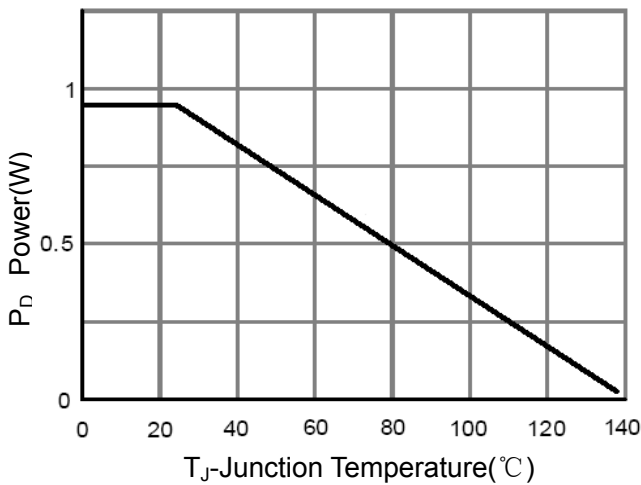

Figure 3 Power Dissipation

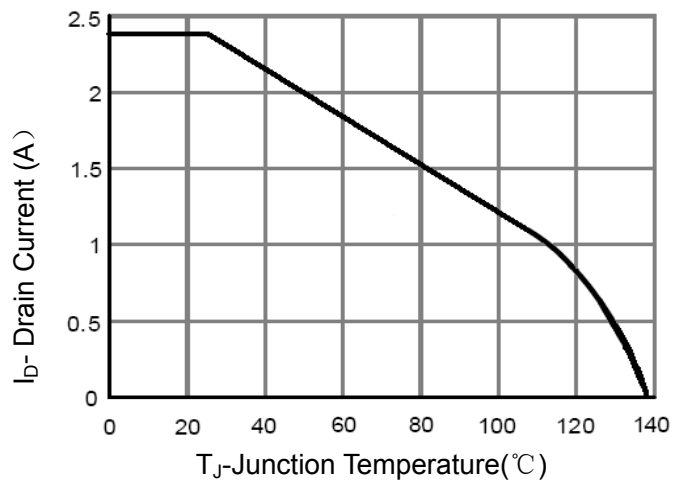

Figure 4 Drain Current

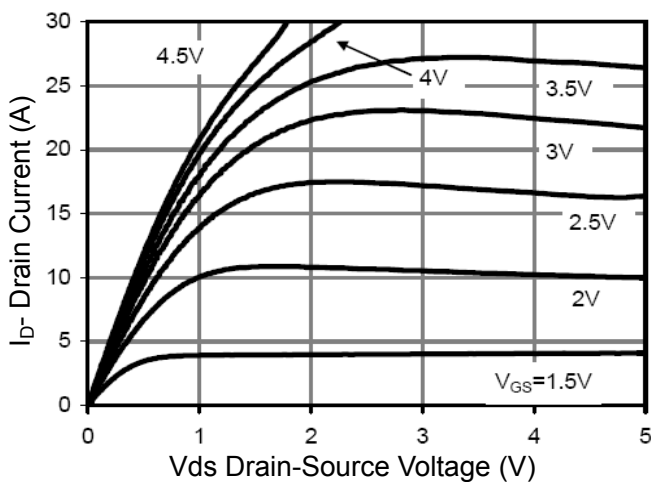

Figure 5 Output CHARACTERISTICS

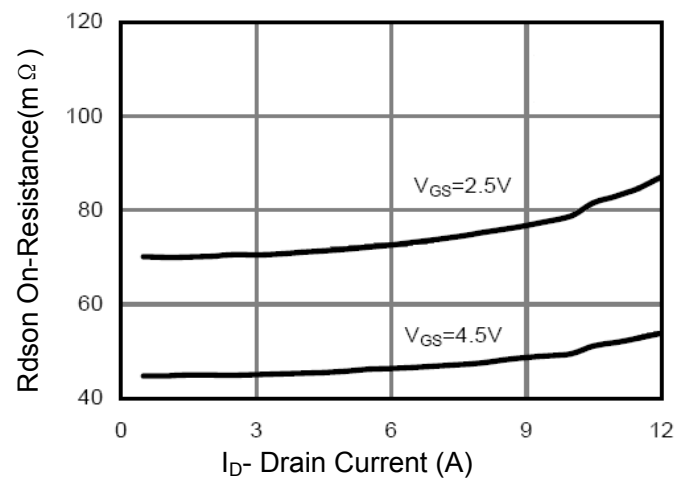
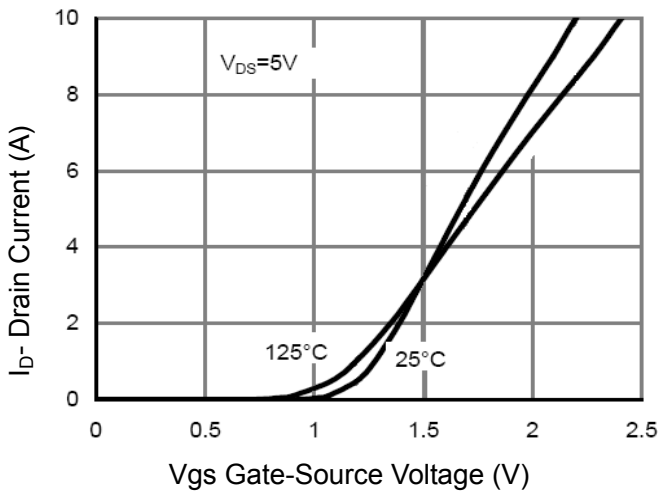
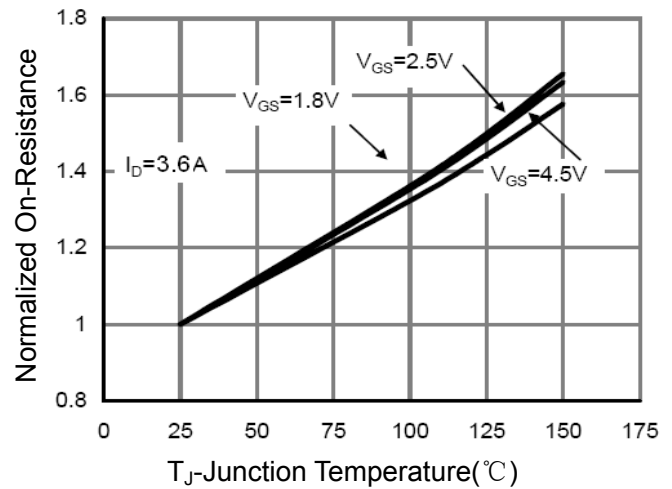

Figure 6 Drain-Source On-Resistance



**Figure 7 Transfer Characteristics**



**Figure 8 Drain-Source On-Resistance**

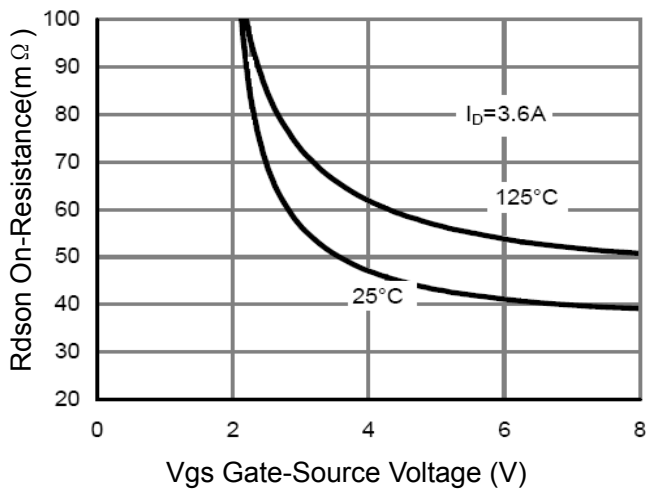

**Figure 9 Rdson vs Vgs**

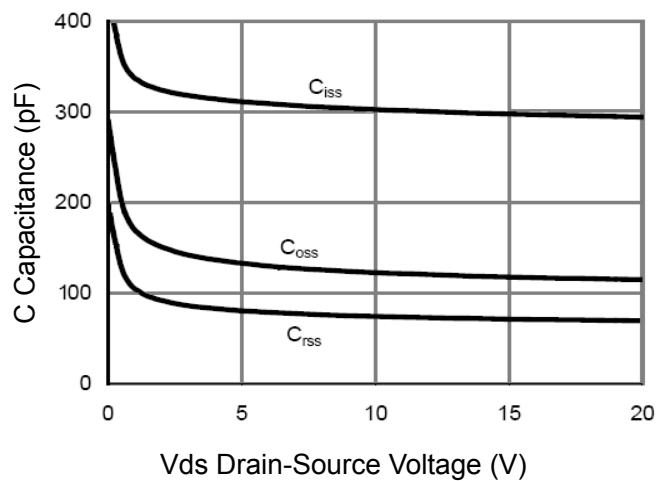

**Figure 10 Capacitance vs Vds**

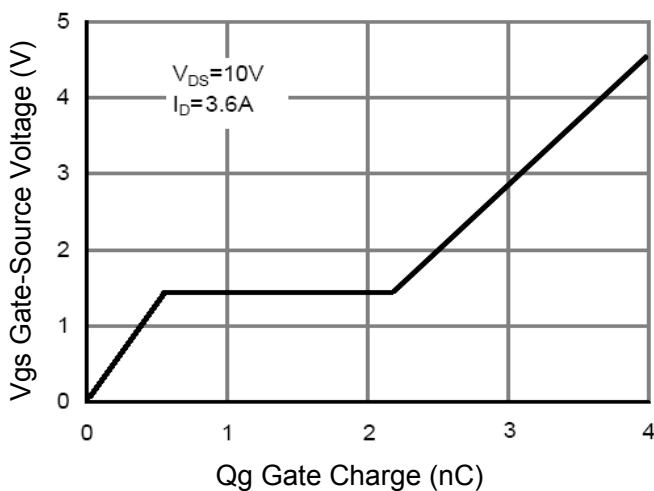

**Figure 11 Gate Charge**

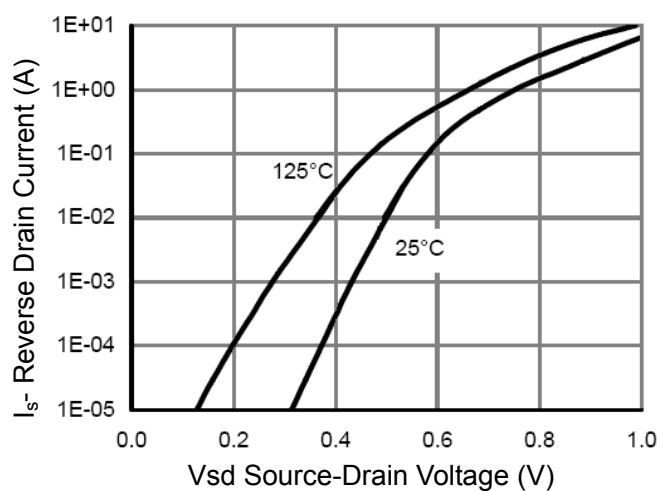

**Figure 12 Source- Drain Diode Forward**

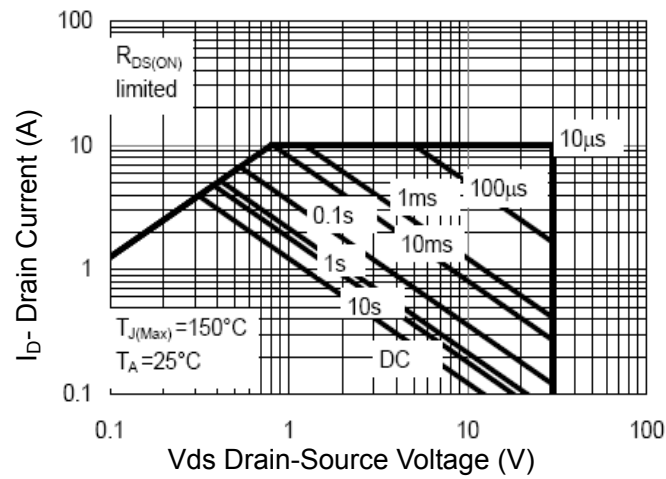

**Figure 13 Safe Operation Area**

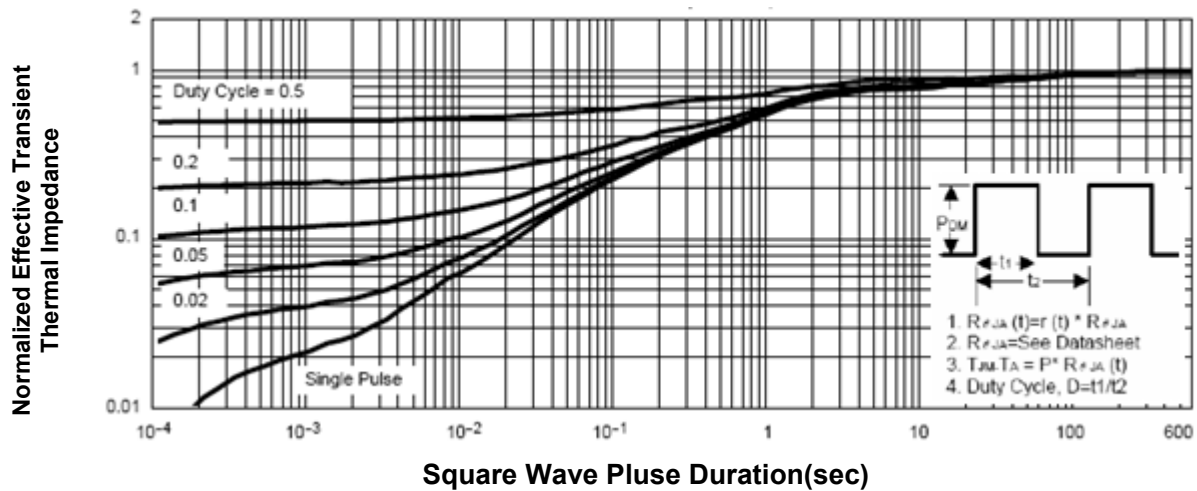

**Figure 14 Normalized Maximum Transient Thermal Impedance**

## SOT-23 PACKAGE INFORMATION

Dimensions in Millimeters (UNIT:mm)

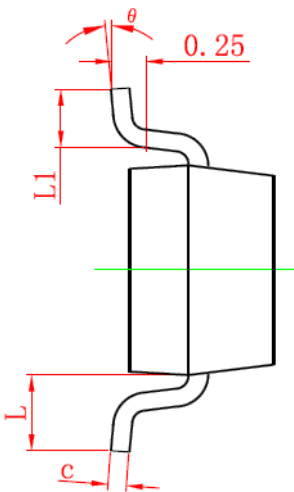
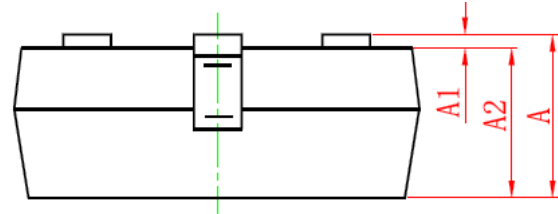
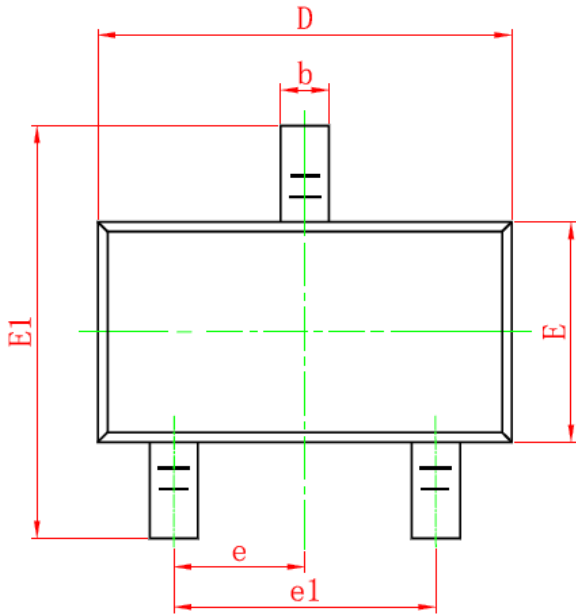

Symbol	Dimensions in Millimeters	
	MIN.	MAX.
A	0.900	1.150
A1	0.000	0.100
A2	0.900	1.050
b	0.300	0.500
c	0.080	0.150
D	2.800	3.000
E	1.200	1.400
E1	2.250	2.550
e	0.950TYP	
e1	1.800	2.000
L	0.550REF	
L1	0.300	0.500
$\theta$	0°	8°

### NOTES

1. All dimensions are in millimeters.
2. Tolerance  $\pm 0.10\text{mm}$  (4 mil) unless otherwise specified
3. Package body sizes exclude mold flash and gate burrs. Mold flash at the non-lead sides should be less than 5 mils.
4. Dimension L is measured in gauge plane.
5. Controlling dimension is millimeter, converted inch dimensions are not necessarily exact.

## ATTENTION:

- Any and all Silikron products described or contained herein do not have specifications that can handle applications that require extremely high levels of reliability, such as life-support systems, aircraft's control systems, or other applications whose failure can be reasonably expected to result in serious physical and/or material damage. Consult with your Silikron representative nearest you before using any Silikron products described or contained herein in such applications.
- Silikron assumes no responsibility for equipment failures that result from using products at values that exceed, even momentarily, rated values (such as maximum ratings, operating condition ranges, or other parameters) listed in products specifications of any and all Silikron products described or contained herein.
- Specifications of any and all Silikron products described or contained herein stipulate the performance, characteristics, and functions of the described products in the independent state, and are not guarantees of the performance, characteristics, and functions of the described products as mounted in the customer's products or equipment. To verify symptoms and states that cannot be evaluated in an independent device, the customer should always evaluate and test devices mounted in the customer's products or equipment.
- Silikron Semiconductor CO.,LTD. strives to supply high-quality high-reliability products. However, any and all semiconductor products fail with some probability. It is possible that these probabilistic failures could give rise to accidents or events that could endanger human lives, that could give rise to smoke or fire, or that could cause damage to other property. When designing equipment, adopt safety measures so that these kinds of accidents or events cannot occur. Such measures include but are not limited to protective circuits and error prevention circuits for safe design, redundant design, and structural design.
- In the event that any or all Silikron products(including technical data, services) described or contained herein are controlled under any of applicable local export control laws and regulations, such products must not be exported without obtaining the export license from the authorities concerned in accordance with the above law.
- No part of this publication may be reproduced or transmitted in any form or by any means, electronic or mechanical, including photocopying and recording, or any information storage or retrieval system, or otherwise, without the prior written permission of Silikron Semiconductor CO.,LTD.
- Information (including circuit diagrams and circuit parameters) herein is for example only ; it is not guaranteed for volume production. Silikron believes information herein is accurate and reliable, but no guarantees are made or implied regarding its use or any infringements of intellectual property rights or other rights of third parties.
- Any and all information described or contained herein are subject to change without notice due to product/technology improvement, etc. When designing equipment, refer to the "Delivery Specification" for the Silikron product that you intend to use.
- This catalog provides information as of Dec, 2008. Specifications and information herein are subject to change without notice.