

SKiiP 04ACB066V1

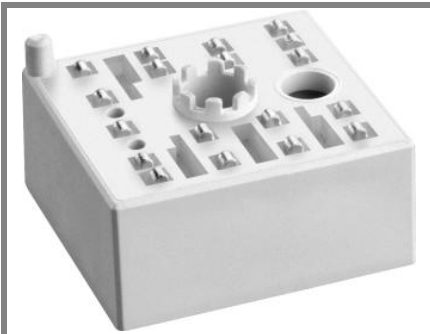

MiniSkiiP[®] 0

3-phase bridge inverter +
brake chopper

SkiiP 04ACB066V1

Features

- Trench IGBT's
- Robust and soft freewheeling diodes in CAL technology
- Highly reliable spring contacts for electrical connections
- UL recognised file no. E63532

Typical Applications

- Inverter up to 6,3 kVA
- Typical motor power 4 kW

Remarks

- Case temperature limited to $T_C = 125^\circ\text{C}$ max.
- Product reliability results are valid for $T_j = 150^\circ\text{C}$
- SC data: $t_p \leq 6 \mu\text{s}$; $V_{GE} \leq 15 \text{ V}$; $T_j = 150^\circ\text{C}$; $V_{CC} = 360 \text{ V}$
- V_{CEsat} , V_F = chip level value

Absolute Maximum Ratings		$T_S = 25^\circ\text{C}$, unless otherwise specified	
Symbol	Conditions	Values	Units
IGBT - Inverter			
V_{CES}		600	V
I_C	$T_S = 25 (70)^\circ\text{C}$, $T_j = 150^\circ\text{C}$	30 (21)	A
I_C	$T_S = 25 (70)^\circ\text{C}$, $T_j = 175^\circ\text{C}$	33 (25)	A
I_{CRM}	$t_p = 1 \text{ ms}$	40	A
V_{GES}		± 20	V
T_j		-40 ... +175	$^\circ\text{C}$
Diode - Inverter			
I_F	$T_S = 25 (70)^\circ\text{C}$, $T_j = 150^\circ\text{C}$	24 (16)	A
I_F	$T_S = 25 (70)^\circ\text{C}$, $T_j = 175^\circ\text{C}$	31 (23)	A
I_{FRM}	$t_p = 1 \text{ ms}$	40	A
T_j		-40 ... +175	$^\circ\text{C}$
I_{HRMS}	per power terminal (20 A / spring)	20	A
T_{stg}	$T_{op} \leq T_{stg}$	-40 ... +125	$^\circ\text{C}$
V_{isol}	AC, 1 min.	2500	V

Characteristics		$T_S = 25^\circ\text{C}$, unless otherwise specified			
Symbol	Conditions	min.	typ.	max.	Units
IGBT - Inverter, Chopper					
V_{CEsat}	$I_{Cnom} = 20 \text{ A}$, $T_j = 25 (150)^\circ\text{C}$	1,1	1,45 (1,65)	1,85 (2,05)	V
$V_{GE(th)}$	$V_{GE} = V_{CE}$, $I_C = 1 \text{ mA}$		5,8		V
$V_{CE(TO)}$	$T_j = 25 (150)^\circ\text{C}$		0,9 (0,85)	1 (0,9)	V
r_T	$T_j = 25 (150)^\circ\text{C}$		30 (43)	45 (60)	m Ω
C_{ies}	$V_{CE} = 25 \text{ V}$, $V_{GE} = 0 \text{ V}$, $f = 1 \text{ MHz}$		1,13		nF
C_{oes}	$V_{CE} = 25 \text{ V}$, $V_{GE} = 0 \text{ V}$, $f = 1 \text{ MHz}$		0,25		nF
C_{res}	$V_{CE} = 25 \text{ V}$, $V_{GE} = 0 \text{ V}$, $f = 1 \text{ MHz}$		0,18		nF
$R_{CC+EE'}$	spring contact-chip $T_S = 25 (150)^\circ\text{C}$				m Ω
$R_{th(j-s)}$	per IGBT		1,6		K/W
$t_{d(on)}$	under following conditions		20		ns
t_r	$V_{CC} = 300 \text{ V}$, $V_{GE} = \pm 15 \text{ V}$		30		ns
$t_{d(off)}$	$I_{Cnom} = 20 \text{ A}$, $T_j = 150^\circ\text{C}$		175		ns
t_f	$R_{Gon} = R_{Goff} = 15 \Omega$		50		ns
$E_{on}(E_{off})$	inductive load		0,8 (0,7)		mJ
Diode - Inverter, Chopper					
$V_F = V_{EC}$	$I_{Fnom} = 20 \text{ A}$, $T_j = 25 (150)^\circ\text{C}$		1,6 (1,65)	1,9 (1,95)	V
$V_{(TO)}$	$T_j = 25 (150)^\circ\text{C}$		1 (0,9)	1,1 (1)	V
r_T	$T_j = 25 (150)^\circ\text{C}$		30 (37,5)	40 (42,5)	m Ω
$R_{th(j-s)}$	per diode		2,5		K/W
I_{RRM}	under following conditions		25		A
Q_{rr}	$I_{Fnom} = 20 \text{ A}$, $V_R = 300 \text{ V}$		2,3		μC
E_{rr}	$V_{GE} = 0 \text{ V}$, $T_j = 150^\circ\text{C}$		0,2		mJ
	$di_F/dt = 1240 \text{ A}/\mu\text{s}$				
Temperature Sensor					
R_{ts}	3 %, $T_r = 25 (100)^\circ\text{C}$		1000(1670)		Ω
Mechanical Data					
m			21,5		g
M_s	Mounting torque	2		2,5	Nm

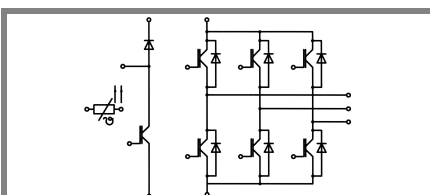

ACB

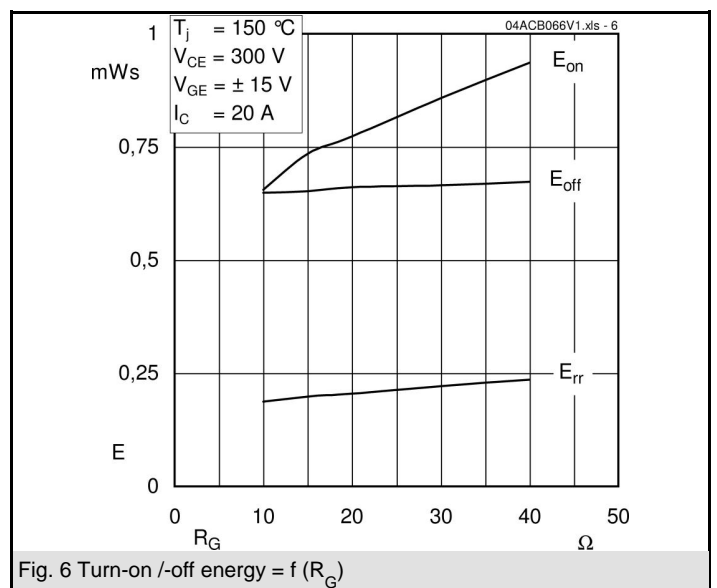
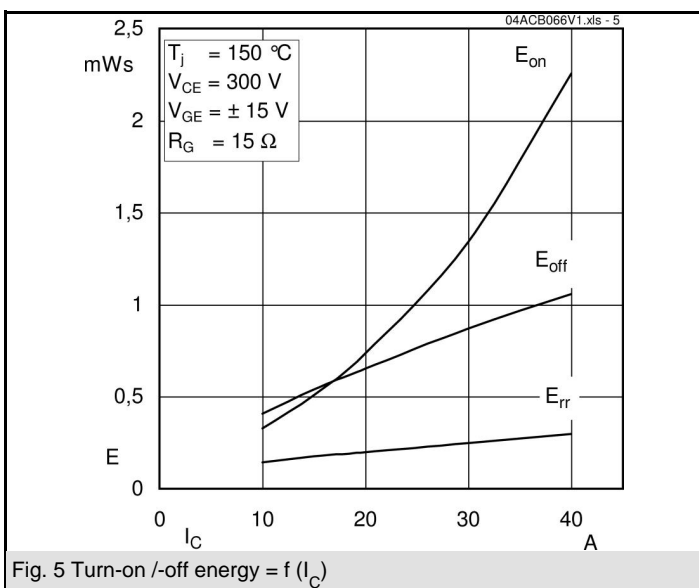
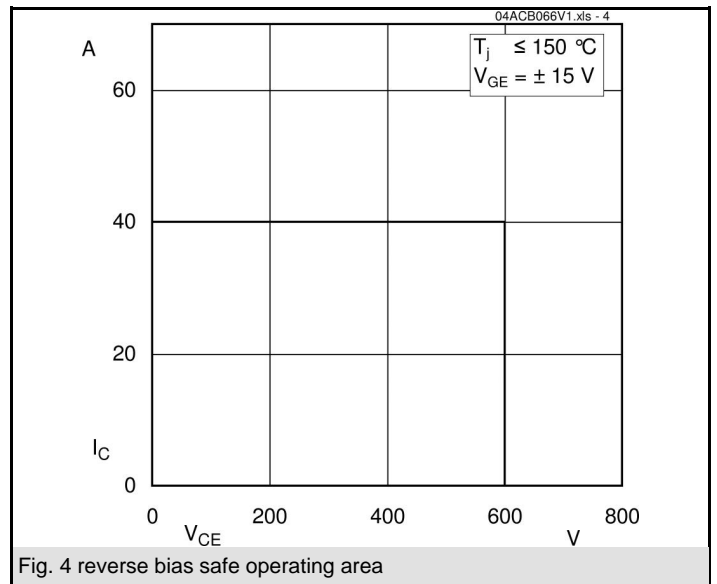
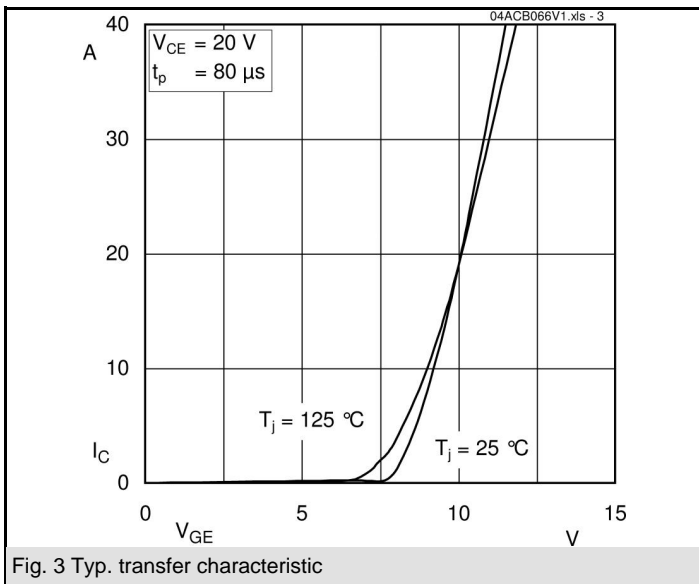
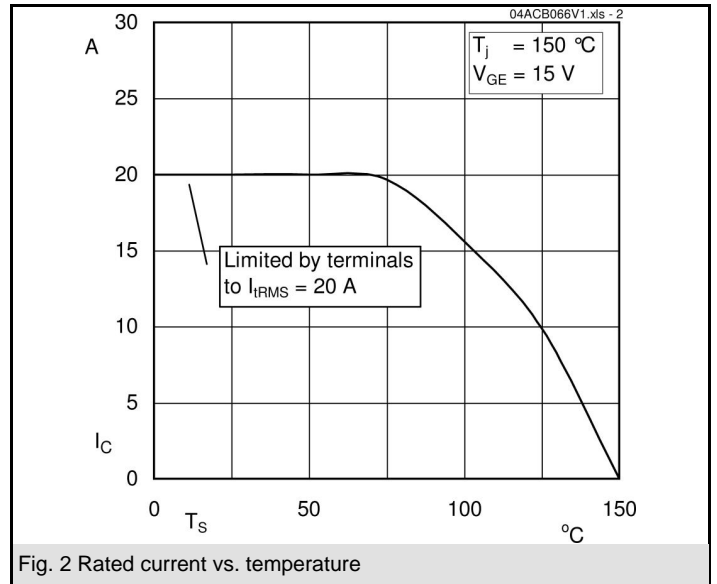
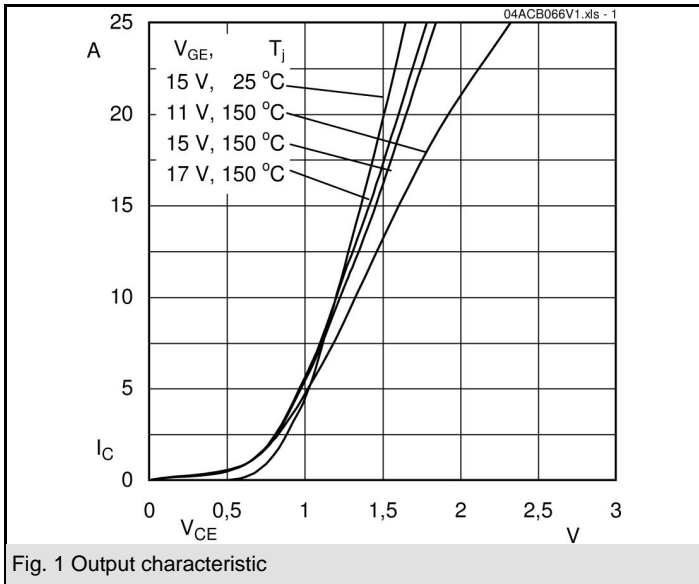

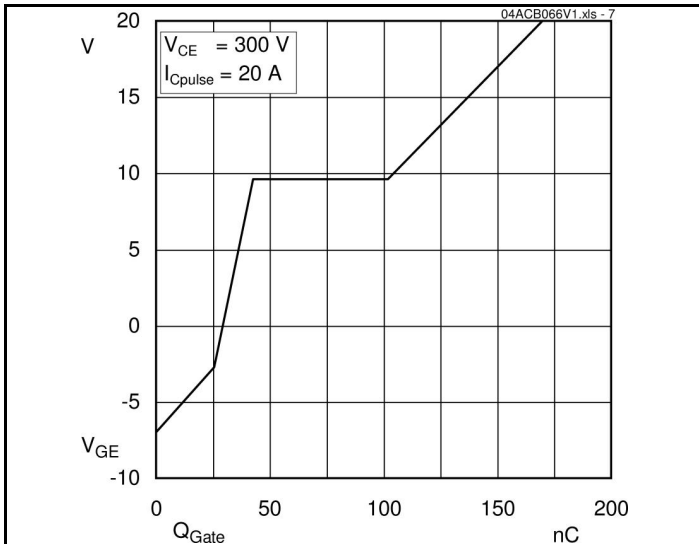

Fig. 7 Typ. Gate charge characteristic

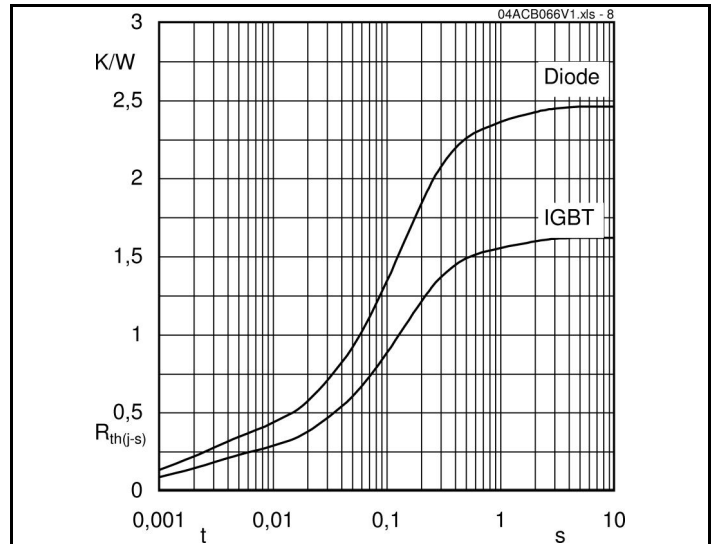

Fig. 8 Thermal impedance

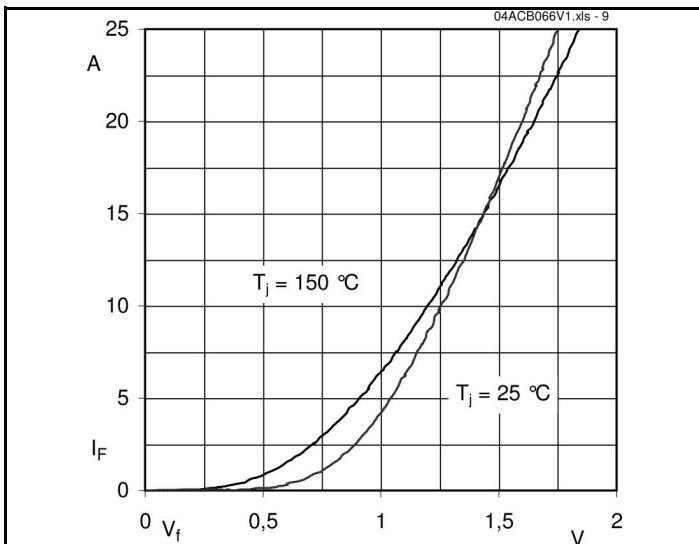
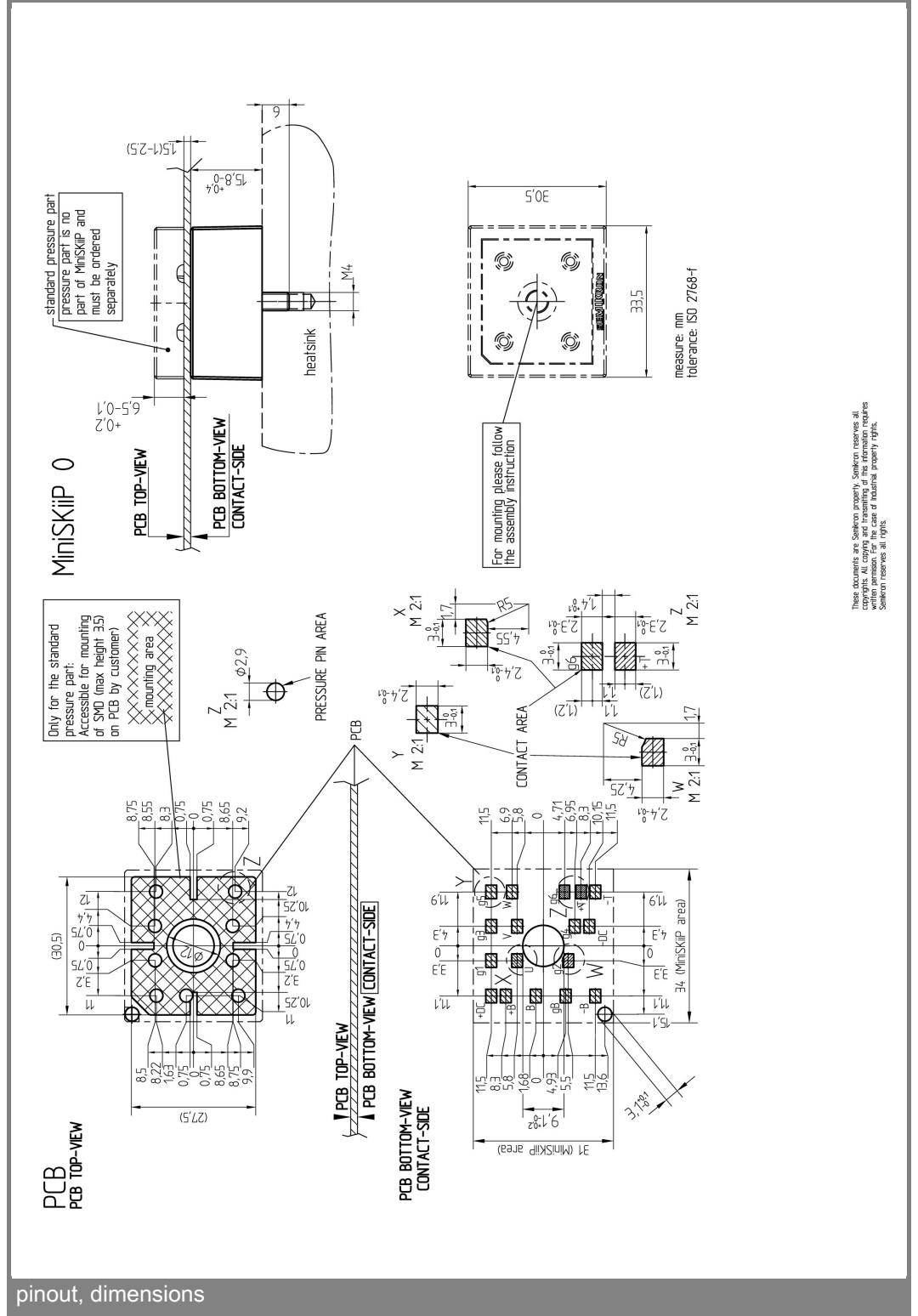
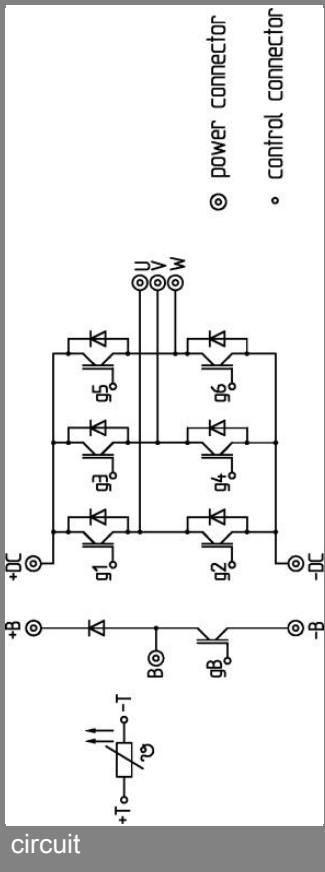

Fig. 9 Typ. freewheeling diode forward characteristic



These documents are customer property. Customer reserves all copyrights. All copying and transmitting of this information requires written permission. For the case of industrial property rights, SEMIKRON reserves all rights.

This is an electrostatic discharge sensitive device (ESDS), international standard IEC 60747-1, Chapter IX.

This technical information specifies semiconductor devices but promises no characteristics. No warranty or guarantee expressed or implied is made regarding delivery, performance or suitability.