

PLEASE CHECK WWW.MOLEX.COM FOR LATEST PART INFORMATION

Part Number: [0436500801](#)
Status: **Active**
Overview: [microfit_30](#)
Description: 3.00mm (.118") Pitch Micro-Fit 3.0™ Header, Surface Mount Compatible, Single Row, Right Angle, with Snap-in Plastic Peg PCB Lock, 8 Circuits, 0.38µm (15µ") Gold (Au) Selective Plating, Glow Wire Compatible

Documents:

3D Model	Product Specification PS-43650 (PDF)
Drawing (PDF)	RoHS Certificate of Compliance (PDF)
Packaging Specification (PDF)	

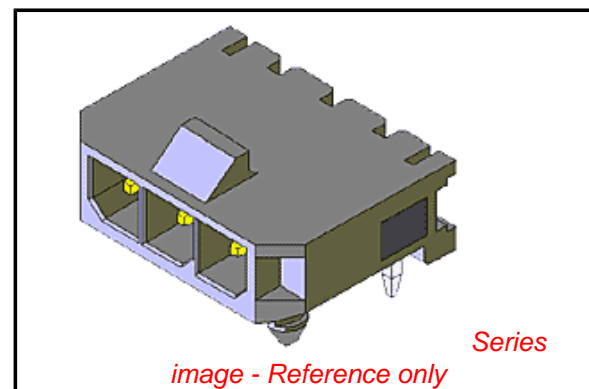

Agency Certification

CSA	LR19980
TUV	R72081037
UL	E29179

General

Product Family	PCB Headers
Series	43650
Application	Wire-to-Board
Comments	Glow Wire Equivalent Part Number 436500801 . High Temperature, Square Pin, Solder Type
Overview	microfit_30
Product Literature Order No	USA-106
Product Name	Micro-Fit 3.0™

Physical

Breakaway	No
Circuits (Loaded)	8
Circuits (maximum)	8
Color - Resin	Black
Durability (mating cycles max)	30
Flammability	94V-0
Glow-Wire Compliant	Yes
Mated Height (in)	0.275 In
Mated Height (mm)	6.98 mm
Material - Metal	Brass
Material - Plating Mating	Gold
Material - Plating Termination	Tin
Material - Resin	High Temperature Thermoplastic
Number of Rows	1
Orientation	Right Angle
PCB Locator	Yes
PCB Retention	Yes
PCB Thickness Recommended (in)	0.062 In
PCB Thickness Recommended (mm)	1.60 mm
Packaging Type	Tray
Pitch - Mating Interface (in)	0.118 In
Pitch - Mating Interface (mm)	3.00 mm
Plating min: Mating (µin)	15
Plating min: Mating (µm)	0.375
Plating min: Termination (µin)	100
Plating min: Termination (µm)	2.5
Polarized to PCB	Yes
Shrouded	Fully

EU RoHS

ELV and RoHS Compliant
REACH SVHC
Contains SVHC: No
Halogen-Free Status

China RoHS



Halogen-Free

Need more information on product environmental compliance?

Email productcompliance@molex.com
 For a multiple part number RoHS Certificate of Compliance, [click here](#)

Please visit the [Contact Us](#) section for any non-product compliance questions.

Search Parts in this Series

[43650Series](#)

Mates With

[43645 Micro-Fit 3.0™ Receptacle Housing](#)

Stackable	No
Surface Mount Compatible (SMC)	Yes
Temperature Range - Operating	-40°C to +105°C
Termination Interface: Style	Through Hole

Electrical

Current - Maximum per Contact	5A
Voltage - Maximum	250V

Solder Process Data

Duration at Max. Process Temperature (seconds)	30
Lead-free Process Capability	SMC & Wave Capable (TH only)
Max. Cycles at Max. Process Temperature	3
Process Temperature max. C	260

Material Info

Reference - Drawing Numbers

Packaging Specification	PK-70873-0321
Product Specification	PS-43650
Sales Drawing	SD-43650-001
Test Summary	TS-43045-002

This document was generated on 05/24/2010

PLEASE CHECK WWW.MOLEX.COM FOR LATEST PART INFORMATION

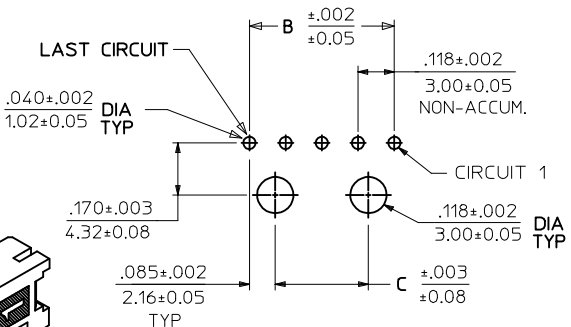
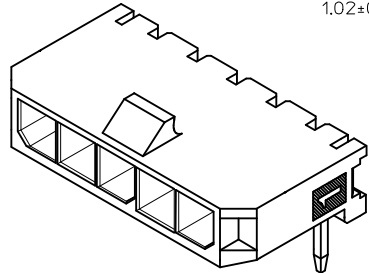
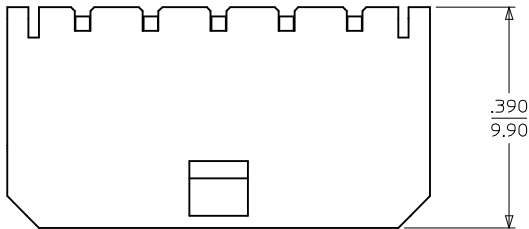

PCB LAYOUT: COMPONENT SIDE
RECOMMENDED PCB THICKNESS: .062/157
4-12 CIRCUIT HEADERS

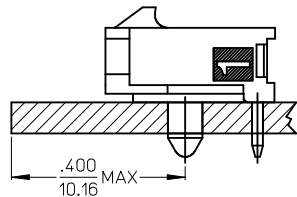
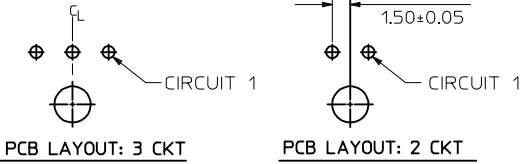
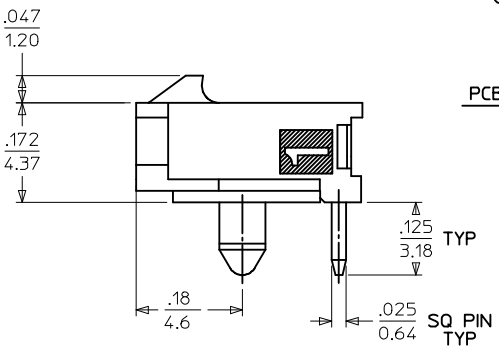
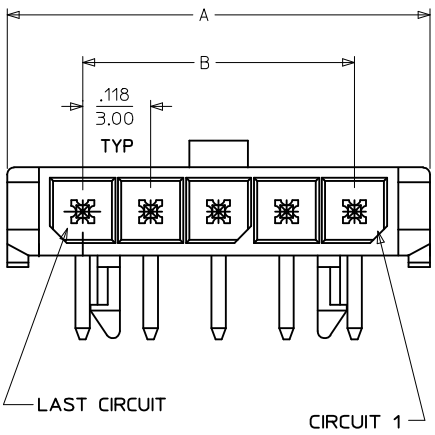

LOCATION DETAIL (SEE NOTE #6)

CKTS	A	B	C
2	.380 9.65	.118 3.00	NA
3	.498 12.65	.236 6.00	NA
4	.616 15.65	.354 9.00	.185 4.70
5	.734 18.64	.472 12.00	.303 7.70
6	.852 21.64	.591 15.00	.421 10.70
7	.970 24.64	.709 18.00	.539 13.70
8	1.088 27.64	.827 21.00	.657 16.70
9	1.206 30.63	.945 24.00	.776 19.70
10	1.325 33.66	1.063 27.00	.894 22.70
11	1.443 36.65	1.181 30.00	1.012 25.70
12	1.561 39.65	1.299 33.00	1.130 28.70

RECEPTACLE #43645

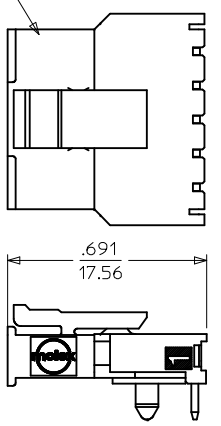

MATED MICRO FIT CONNECTOR

CKTS	FINISH A	FINISH B	FINISH C	FINISH D
	MATERIAL NO:	MATERIAL NO:	MATERIAL NO:	MATERIAL NO:
02	43650-0200	43650-0201	43650-0202	43650-0237
03	43650-0300	43650-0301	43650-0302	
04	43650-0400	43650-0401	43650-0402	
05	43650-0500	43650-0501	43650-0502	
06	43650-0600	43650-0601	43650-0602	
07	43650-0700	43650-0701	43650-0702	
08	43650-0800	43650-0801	43650-0802	
09	43650-0900	43650-0901	43650-0902	
10	43650-1000	43650-1001	43650-1002	
11	43650-1100	43650-1101	43650-1102	
12	43650-1200	43650-1201	43650-1202	

NOTES:

- HOUSING MATERIAL: LIQUID CRYSTAL POLYMER, GLASS FILLED, UL94V-0, COLOR - BLACK
TERMINAL MATERIAL: BRASS ALLOY
- FINISH:
A = .000100/(0.00254) MIN. BRIGHT TIN OVER
.000050/(0.00127) MIN. NICKEL
B = .000015/(0.00038) MIN. SELECT GOLD IN CONTACT AREA
.000100/(0.00254) MIN. SELECT MATTE TIN ON SOLDER TAILS
BOTH OVER .000050/(0.00127) NICKEL OVERALL
C = .000030/(0.00076) MIN. SELECT GOLD IN CONTACT AREA
.000100/(0.00254) MIN. SELECT MATTE TIN ON SOLDER TAILS
BOTH OVER .000050/(0.00127) NICKEL OVERALL
D = .000100/(0.00254) MIN. MATTE TIN OVER
.000050/(0.00127) MIN. NICKEL
- PRODUCT SPECIFICATION: PS-43650
- TRAY PACKAGED : SEE MOLEX DRAWING PK-70873-0321
- MATES WITH MICRO FIT (3.0) RECEPTACLE SERIES 43645
- TO AVOID INTERFERENCE BETWEEN RECEPTACLE AND PCB, HEADER MUST BE PLACED WITHIN .400/(10.16) MAX. FROM EDGE OF PCB, AS SHOWN IN LOCATION DETAIL.
- PARTS CONFORM TO CLASS 'B' REQUIREMENTS OF COSMETIC SPECIFICATION PS-45499-002.

ADD MATTE FINISH EC NO: UCP2009-3156 DRWNS0050SEK 2009/07/01 CHKDKK1P1PR 2009/07/02 APPR:FSMLTH 2009/07/02 D1 REV	QUALITY SYMBOLS ▽=0 ▽=0	GENERAL TOLERANCES (UNLESS SPECIFIED) <table border="1"> <tr> <th></th> <th>mm</th> <th>INCH</th> </tr> <tr> <td>4 PLACES ±</td> <td>---</td> <td>---</td> </tr> <tr> <td>3 PLACES ±</td> <td>---</td> <td>±.010</td> </tr> <tr> <td>2 PLACES ±</td> <td>0.25</td> <td>±.014</td> </tr> <tr> <td>1 PLACE ±</td> <td>0.35</td> <td>---</td> </tr> </table>		mm	INCH	4 PLACES ±	---	---	3 PLACES ±	---	±.010	2 PLACES ±	0.25	±.014	1 PLACE ±	0.35	---	DIMENSION STYLE IN/MM	SCALE ---	DESIGN UNITS METRIC	THIRD ANGLE PROJECTION
		mm	INCH																		
	4 PLACES ±	---	---																		
	3 PLACES ±	---	±.010																		
2 PLACES ±	0.25	±.014																			
1 PLACE ±	0.35	---																			
DRAFT WHERE APPLICABLE MUST REMAIN WITHIN DIMENSIONS		DRAWN BY SAMIEC	DATE 2000/07/07	TITLE MICRO-FIT (3.0) SINGLE ROW / RIGHT ANGLE THRU HOLE / PEGS / TRAY																	
MATERIAL NO. SEE CHART		CHECKED BY MUELLER	DATE 2000/07/07	MOLEX INCORPORATED																	
APPROVED BY EDGLEY		DATE 2000/07/07	DOCUMENT NO. SD-43650-001																		