

# IRF7207

HEXFET® Power MOSFET

- Generation 5 Technology
- P-Channel Mosfet
- Surface Mount
- Available in Tape & Reel
- Dynamic dv/dt Rating
- Fast Switching

www.DataSheet4U.com

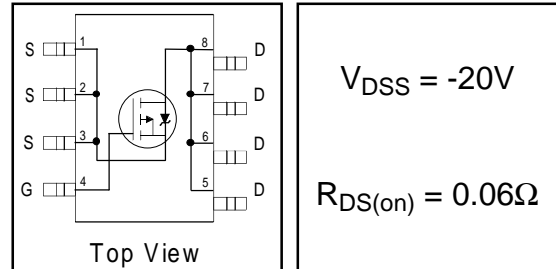

## Description

Fifth Generation HEXFET® Power MOSFETs from International Rectifier utilize advanced processing techniques to achieve extremely low on-resistance per silicon area. This benefit, combined with the fast switching speed and ruggedized device design that HEXFET power MOSFETs are well known for, provides the designer with an extremely efficient and reliable device for use in a wide variety of applications.

The SO-8 has been modified through a customized leadframe for enhanced thermal characteristics and multiple-die capability making it ideal in a variety of power applications. With these improvements, multiple devices can be used in an application with dramatically reduced board space. The package is designed for vapor phase, infra red, or wave soldering techniques. Power dissipation of greater than 0.8W is possible in a typical PCB mount application.

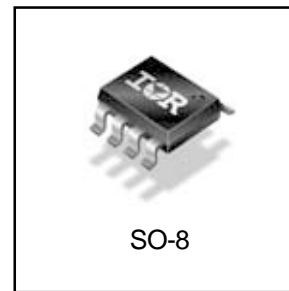

## Absolute Maximum Ratings

	Parameter	Max.	Units
$V_{DS}$	Drain- Source Voltage	-20	V
$I_D @ T_C = 25^\circ C$	Continuous Drain Current, $V_{GS} @ -4.5V$	-5.4	A
$I_D @ T_C = 70^\circ C$	Continuous Drain Current, $V_{GS} @ -4.5V$	-4.3	
$I_{DM}$	Pulsed Drain Current ①	-43	
$P_D @ T_C = 25^\circ C$	Power Dissipation	2.5	W
$P_D @ T_C = 70^\circ C$	Power Dissipation	1.6	
	Linear Derating Factor	0.02	
$V_{GS}$	Gate-to-Source Voltage	$\pm 12$	V
$V_{GSM}$	Gate-to-Source Voltage Single Pulse $t_p < 10\mu s$	-16	V
$E_{AS}$	Single Pulse Avalanche Energy ②	140	
dv/dt	Peak Diode Recovery dv/dt ③	-5.0	V/ns
$T_J, T_{STG}$	Junction and Storage Temperature Range	-55 to + 150	$^\circ C$

## Thermal Resistance

	Parameter	Typ.	Max.	Units
$R_{\theta JA}$	Maximum Junction-to-Ambient ⑤	—	50	$^\circ C/W$

www.irf.com

1

6/5/00

# IRF7207

International  
IR Rectifier

## Electrical Characteristics @ $T_J = 25^\circ\text{C}$ (unless otherwise specified)

	Parameter	Min.	Typ.	Max.	Units	Conditions
$V_{(BR)DSS}$	Drain-to-Source Breakdown Voltage	-20	—	—	V	$V_{GS} = 0V, I_D = -250\mu A$
$\Delta V_{(BR)DSS}/\Delta T_J$	Breakdown Voltage Temp. Coefficient	—	-0.011	—	V/ $^\circ\text{C}$	Reference to $25^\circ\text{C}$ , $I_D = -1\text{mA}$
$R_{DS(on)}$	Static Drain-to-Source On-Resistance	—	—	0.06	$\Omega$	$V_{GS} = -4.5V, I_D = -5.4A$ ④
		—	—	0.10		$V_{GS} = -2.7V, I_D = -2.7A$ ④
$V_{GS(th)}$	Gate Threshold Voltage	-0.7	—	—	V	$V_{DS} = V_{GS}, I_D = -250\mu A$
$g_{fs}$	Forward Transconductance	8.3	—	—	S	$V_{DS} = -10V, I_D = -5.4A$
$I_{DSS}$	Drain-to-Source Leakage Current	—	—	-1.0	$\mu A$	$V_{DS} = -16V, V_{GS} = 0V$
		—	—	-25		$V_{DS} = -16V, V_{GS} = 0V, T_J = 125^\circ\text{C}$
$I_{GSS}$	Gate-to-Source Forward Leakage	—	—	-100	nA	$V_{GS} = 12V$
	Gate-to-Source Reverse Leakage	—	—	100		$V_{GS} = -12V$
$Q_g$	Total Gate Charge	—	15	22	nC	$I_D = -5.4A$
$Q_{gs}$	Gate-to-Source Charge	—	2.2	3.3		$V_{DS} = -10V$
$Q_{gd}$	Gate-to-Drain ("Miller") Charge	—	5.7	8.6		$V_{GS} = -4.5V, \text{④}$
$t_{d(on)}$	Turn-On Delay Time	—	11	—		$V_{DD} = -10V$
$t_r$	Rise Time	—	24	—	ns	$I_D = -1.0A$
$t_{d(off)}$	Turn-Off Delay Time	—	43	—		$R_G = 6.0\Omega$
$t_f$	Fall Time	—	41	—		$R_D = 10\Omega, \text{④}$
$C_{iss}$	Input Capacitance	—	780	—	pF	$V_{GS} = 0V$
$C_{oss}$	Output Capacitance	—	410	—		$V_{DS} = -15V$
$C_{rss}$	Reverse Transfer Capacitance	—	200	—		$f = 1.0\text{MHz}$ ,

## Source-Drain Ratings and Characteristics

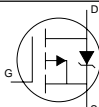
	Parameter	Min.	Typ.	Max.	Units	Conditions
$I_S$	Continuous Source Current (Body Diode)	—	—	-3.1	A	MOSFET symbol showing the integral reverse p-n junction diode. 
$I_{SM}$	Pulsed Source Current (Body Diode) ①	—	—	-43		
$V_{SD}$	Diode Forward Voltage	—	—	-1.0	V	$T_J = 25^\circ\text{C}, I_S = -3.1A, V_{GS} = 0V$ ③
$t_{rr}$	Reverse Recovery Time	—	42	63	ns	$T_J = 25^\circ\text{C}, I_F = -3.1A$
$Q_{rr}$	Reverse Recovery Charge	—	50	75	nC	$di/dt = -100A/\mu s$ ③

### Notes:

- ① Repetitive rating; pulse width limited by max. junction temperature.
- ② Starting  $T_J = 25^\circ\text{C}$ ,  $L = 9.6\text{mH}$   
 $R_G = 25\Omega, I_{AS} = -5.4A$ .
- ③  $I_{SD} \leq -5.4A, di/dt \leq -79A/\mu s, V_{DD} \leq V_{(BR)DSS}, T_J \leq 150^\circ\text{C}$
- ④ Pulse width  $\leq 300\mu s$ ; duty cycle  $\leq 2\%$ .
- ⑤ When mounted on 1 inch square copper board,  $t_c < 10$  sec

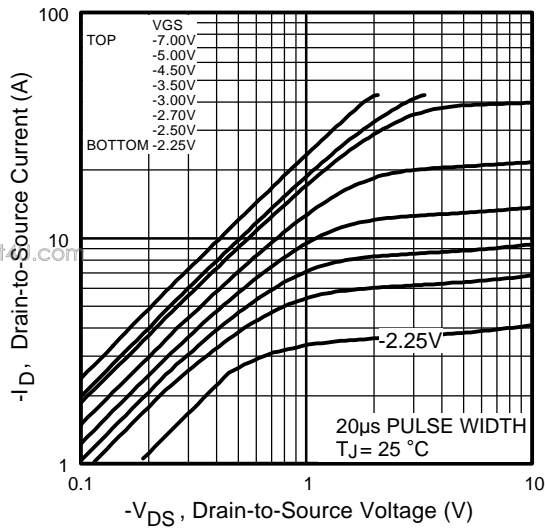

Fig 1. Typical Output Characteristics

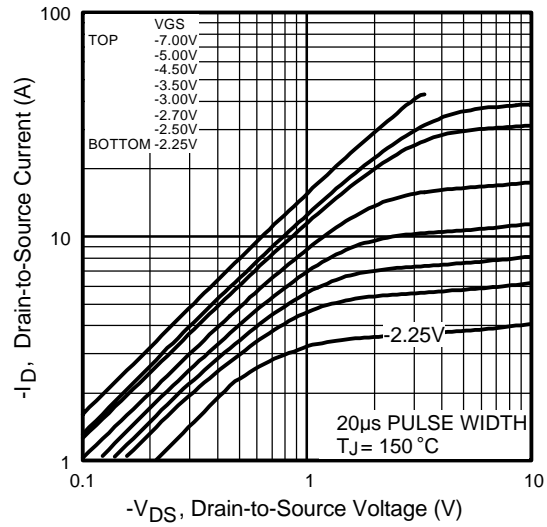

Fig 2. Typical Output Characteristics

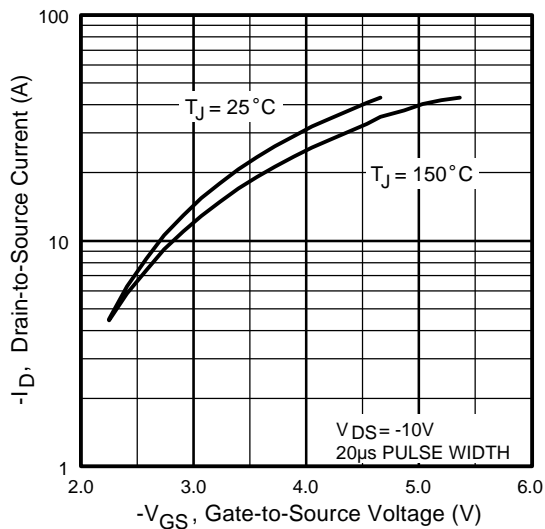

Fig 3. Typical Transfer Characteristics

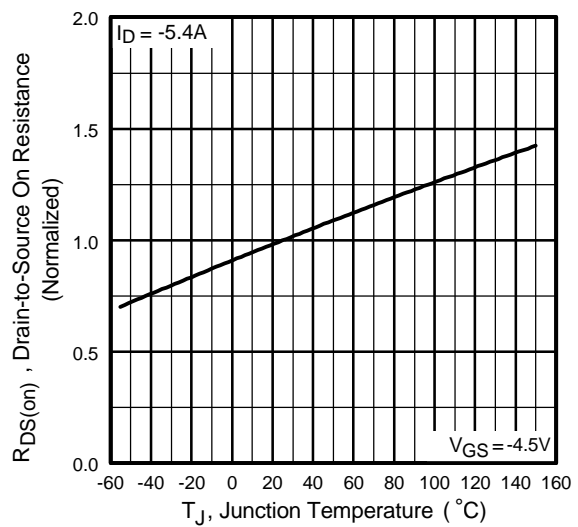
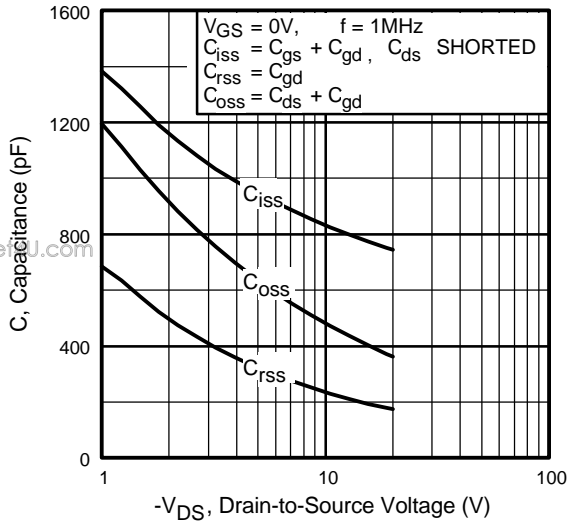

Fig 4. Normalized On-Resistance Vs. Temperature

# IRF7207

International  
**IR** Rectifier



**Fig 5.** Typical Capacitance Vs. Drain-to-Source Voltage

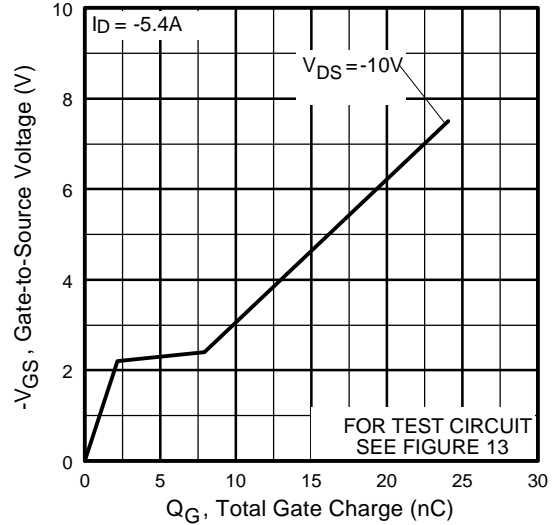

**Fig 6.** Typical Gate Charge Vs. Gate-to-Source Voltage

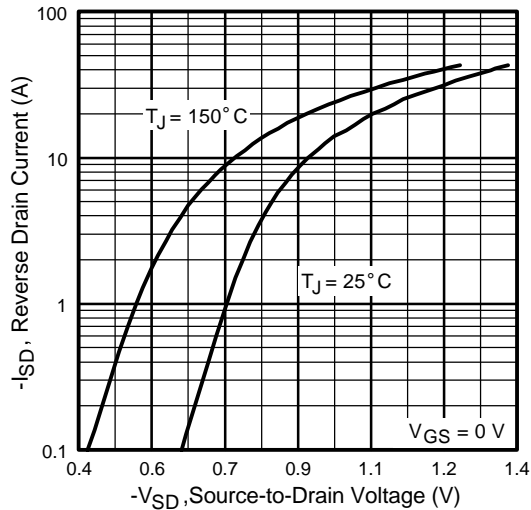

**Fig 7.** Typical Source-Drain Diode Forward Voltage

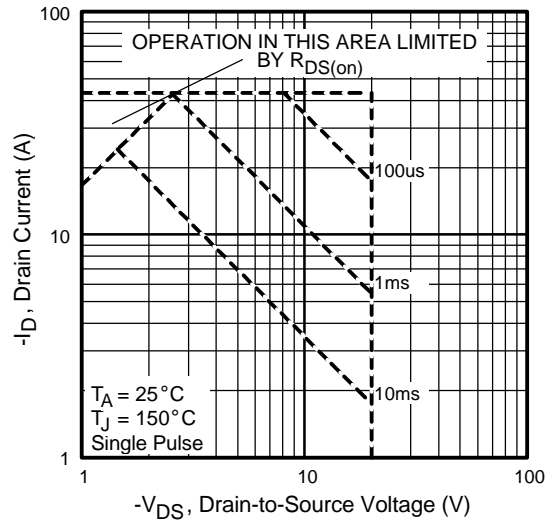

**Fig 8.** Maximum Safe Operating Area

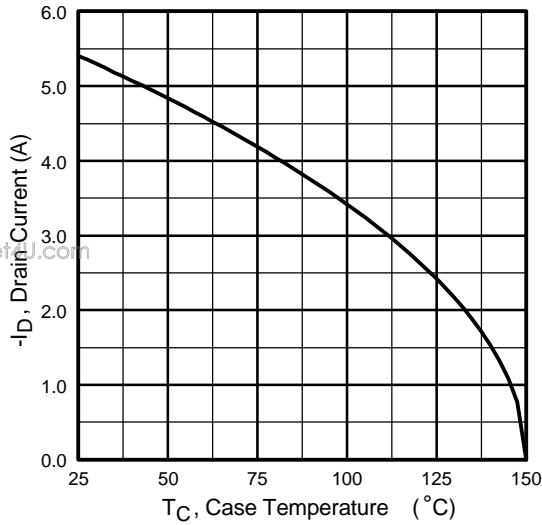

Fig 9. Maximum Drain Current Vs. Case Temperature

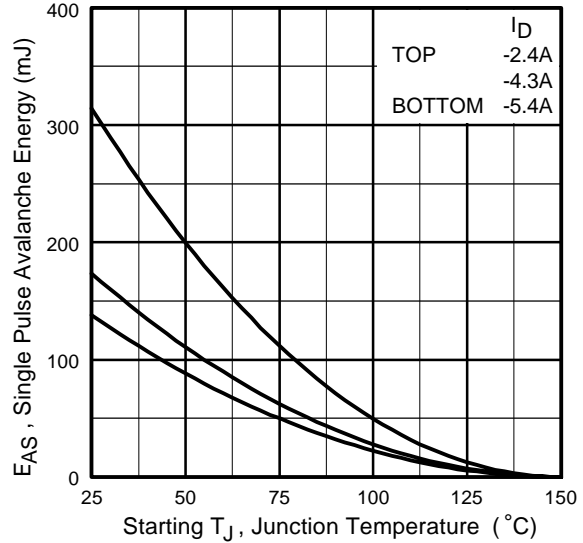

Fig 10. Maximum Avalanche Energy Vs. Drain Current

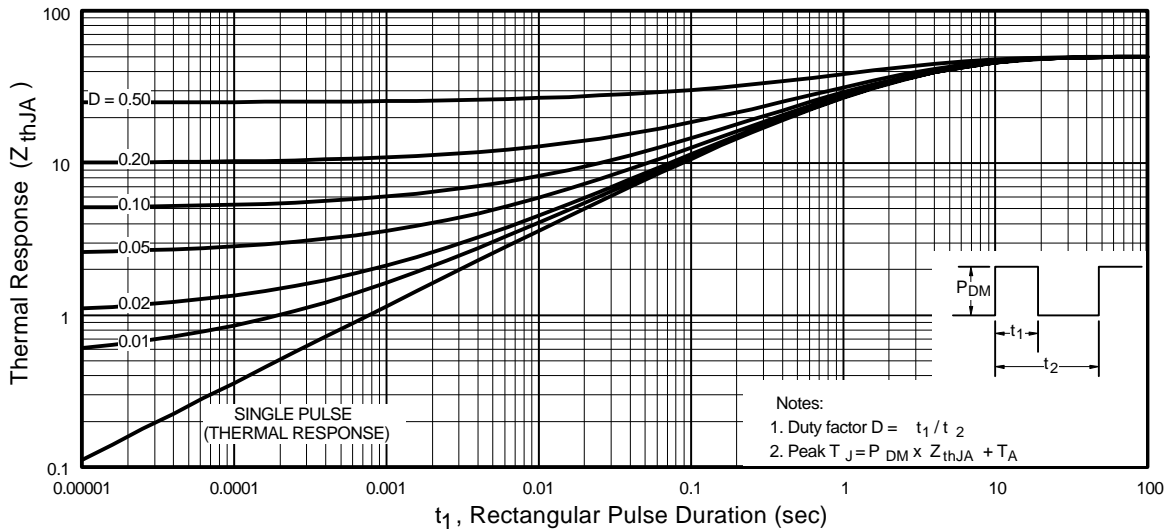
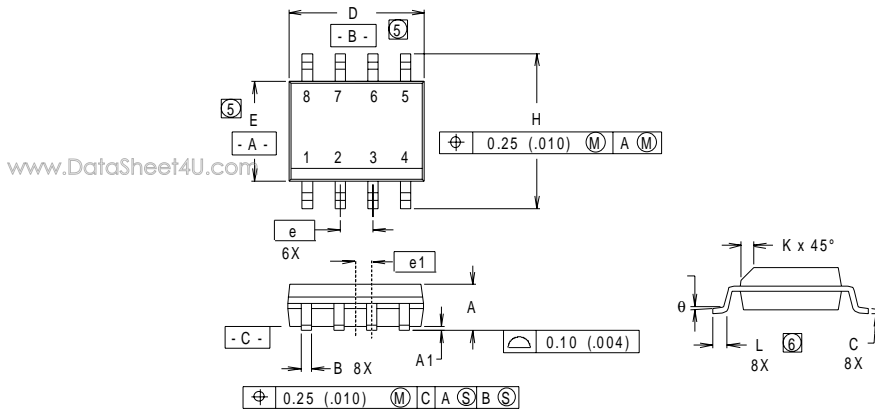

Fig 11. Maximum Effective Transient Thermal Impedance, Junction-to-Ambient

# IRF7207

International  
**IR** Rectifier

## SO-8 Package Details



DIM	INCHES		MILLIMETERS	
	MIN	MAX	MIN	MAX
A	.0532	.0688	1.35	1.75
A1	.0040	.0098	0.10	0.25
B	.014	.018	0.36	0.46
C	.0075	.0098	0.19	0.25
D	.189	.196	4.80	4.98
E	.150	.157	3.81	3.99
e	.050 BASIC		1.27 BASIC	
e1	.025 BASIC		0.635 BASIC	
H	.2284	.2440	5.80	6.20
K	.011	.019	0.28	0.48
L	0.16	.050	0.41	1.27
$\theta$	0°	8°	0°	8°

### RECOMMENDED FOOTPRINT

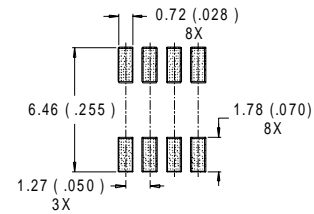

### NOTES:

1. DIMENSIONING AND TOLERANCING PER ANSI Y14.5M-1982.
2. CONTROLLING DIMENSION : INCH.
3. DIMENSIONS ARE SHOWN IN MILLIMETERS (INCHES).
4. OUTLINE CONFORMS TO JEDEC OUTLINE MS-012AA.
- ⑤ DIMENSION DOES NOT INCLUDE MOLD PROTRUSIONS  
MOLD PROTRUSIONS NOT TO EXCEED 0.25 (.006).
- ⑥ DIMENSIONS IS THE LENGTH OF LEAD FOR SOLDERING TO A SUBSTRATE..

## Part Marking

EXAMPLE: THIS IS AN IRF7101

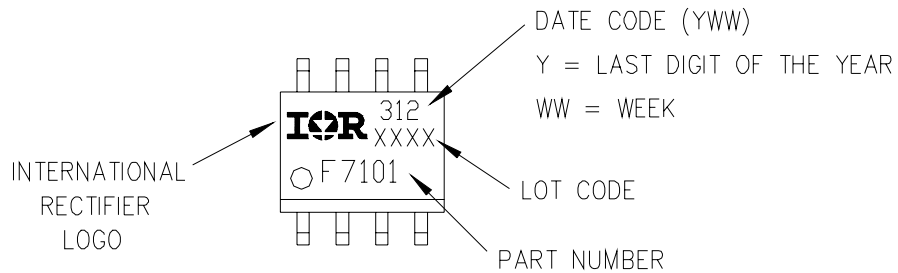

## Tape and Reel

www.DataSheet4U.com

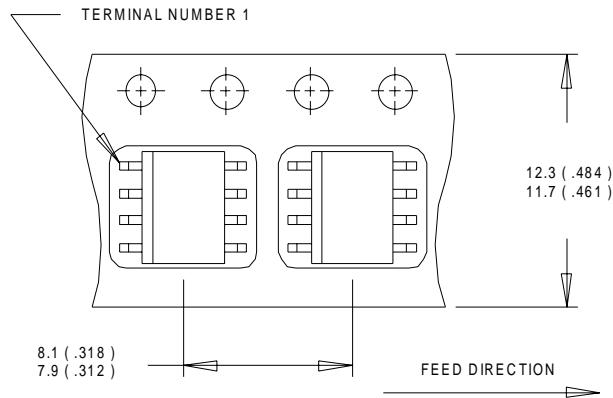

- NOTES:
1. CONTROLLING DIMENSION : MILLIMETER.
  2. ALL DIMENSIONS ARE SHOWN IN MILLIMETERS(INCHES).
  3. OUTLINE CONFORMS TO EIA-481 & EIA-541.

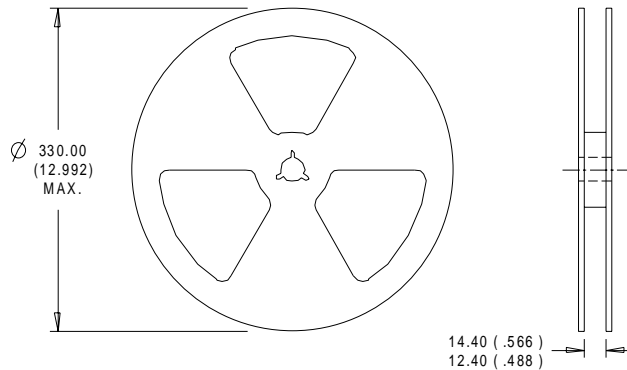

- NOTES :
1. CONTROLLING DIMENSION : MILLIMETER.
  2. OUTLINE CONFORMS TO EIA-481 & EIA-541.

**IR WORLD HEADQUARTERS:** 233 Kansas St., El Segundo, California 90245, USA Tel: (310) 252-7105  
**IR EUROPEAN REGIONAL CENTRE:** 439/445 Godstone Rd, Whyteleafe, Surrey CR3 OBL, UK Tel: ++ 44 (0)20 8645 8000  
**IR CANADA:** 15 Lincoln Court, Brampton, Ontario L6T3Z2, Tel: (905) 453 2200  
**IR GERMANY:** Saalburgstrasse 157, 61350 Bad Homburg Tel: ++ 49 (0) 6172 96590  
**IR ITALY:** Via Liguria 49, 10071 Borgaro, Torino Tel: ++ 39 011 451 0111  
**IR JAPAN:** K&H Bldg., 2F, 30-4 Nishi-Ikebukuro 3-Chome, Toshima-Ku, Tokyo 171 Tel: 81 (0)3 3983 0086  
**IR SOUTHEAST ASIA:** 1 Kim Seng Promenade, Great World City West Tower, 13-11, Singapore 237994 Tel: ++ 65 (0)838 4630  
**IR TAIWAN:** 16 Fl. Suite D. 207, Sec. 2, Tun Haw South Road, Taipei, 10673 Tel: 886-(0)2 2377 9936  
*Data and specifications subject to change without notice. 6/00*