

M4066BP M4066BFP

QUADRUPLE BILATERAL SWITCH

6249826 MITSUBISHI ELEK (LINEAR)

80C 09117 DT-51-11

DESCRIPTION

The M4066BP is a semiconductor integrated circuit consisting of four independent bilateral analog switches.

FEATURES

- Low ON resistance: 50Ω typ. ($V_{DD}=15V$)
- High OFF resistance: $10^9\Omega$ or greater (typ)
- Small differences in ON resistance between each switch in the package: 10Ω typ. ($V_{DD}=15V$)
- Linearized transfer characteristics: 0.07% distortion (typ)
- Wide operating voltage range: $V_{DD}=3\sim 18V$
- Wide operating temperature range: $T_a=-40\sim +85^\circ C$

APPLICATION

General purpose, for use in industrial and consumer digital equipment.

FUNCTIONAL DESCRIPTION

The control input (C_{IN}) can be used to change the input-to-output impedance (IN/OUT-OUT/IN) of the switches. When (C_{IN}) is made high, the input-to-output switch impedance is low and when set to low, this impedance is high. While this device is compatible with the M4016BP, the lower ON resistance and better transfer characteristics allow a larger input voltage range.

Input C_{IN}	Input/output and output/input resistance ($V_{DD}=10V, 15V$)
H	$0.5\sim 3 \times 10^2 \Omega$
L	$> 10^9 \Omega$ (typ)

PIN CONFIGURATION (TOP VIEW)

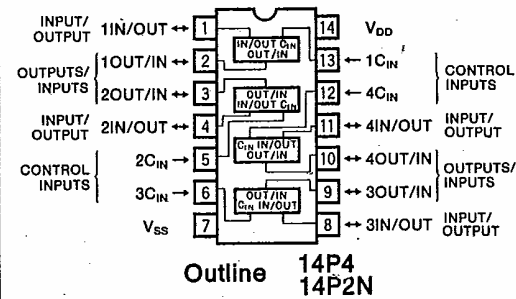

CIRCUIT SCHEMATIC (EACH SWITCH)

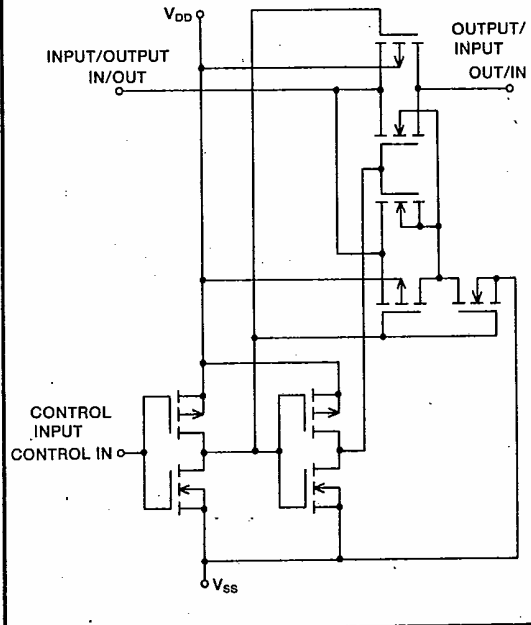

LOGIC DIAGRAM (EACH SWITCH)

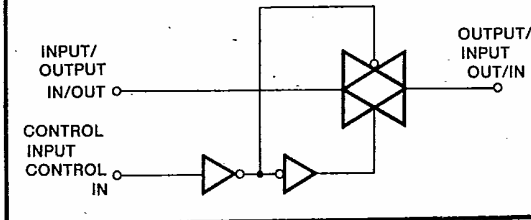

M4066BP M4066BFP

QUADRUPLE BILATERAL SWITCH

6249826 MITSUBISHI ELEK (LINEAR)

80C 09118

D 7-51-11

ABSOLUTE MAXIMUM RATINGS (T_a = -40~+85°C, unless otherwise noted)

Symbol	Parameter	Conditions	Ratings	Unit
V _{DD}	Supply voltage		V _{SS} -0.5~V _{SS} +20	V
V _I	Input voltage		V _{SS} -0.5~V _{DD} +0.5	V
V _{IO}	Input-to-output voltage		±0.5	V
I _I	Input current	Control inputs	±10	mA
I _O	Output current	Switch-off	±10	mA
Topr	Operating temperature range		-40~+85	°C
Tstg	Storage temperature range		-65~+150	°C

RECOMMENDED OPERATING CONDITIONS (T_a = -40~+85°C, V_{SS} = 0V, unless otherwise noted)

Symbol	Parameter	Limits			Unit
		Min	Typ	Max	
V _{DD}	Supply voltage	3		18	V
V _I	Input voltage	0		V _{DD}	V

ELECTRICAL CHARACTERISTICS

Symbol	Parameter	Test conditions	Limits								Unit		
					-40°C			25°C				85°C	
			V _{SS} (V)	V _{DD} (V)	Min	Max	Min	Typ	Max	Min		Max	
V _{IH}	"H" Input voltage (C _{IN})	Input-to-output current=10μA	0	5	3.5		3.5			3.5		V	
			0	10	7.0		7.0			7.0			
			0	15	11.0		11.0			11.0			
V _{IL}	"L" Input current (C _{IN})	Input-to-output current=10μA	0	5		1.5			1.5		1.5	V	
			0	10		2.0			2.0		2.0		
			0	15		2.5			2.5		2.5		
R _{ON}	ON resistance	V _I =5V	0	5		500			600		800	Ω	
		V _I =2.5V	0	5		850			950		1300		
		V _I =0.25V	0	5		500			600		800		
		V _I =10V	0	10		210			250		300		
		V _I =5V	0	10		210			250		300		
		V _I =0.25V	0	10		210			250		300		
		V _I =15V	0	15		140			160		200		
		V _I =7.5V	0	15		140			160		200		
		V _I =0.25V	0	15		140			160		200		
		V _I =5V	-5	5		210			250		300		
		V _I =±0.25V	-5	5		210			250		300		
		V _I =-5V	-5	5		210			250		300		
		V _I =7.5V	-7.5	7.5		140			160		200		
V _I =±0.25V	-7.5	7.5		140			160		200				
V _I =-7.5V	-7.5	7.5		140			160		200				
ΔR _{ON}	ON resistance variations between switches of the same package		-2.5	2.5				30			Ω		
			-5	5				15					
			-7.5	7.5				10					
I _{OFF}	Input/output off-state leakage current	V _{IO} =10V, V _{OI} =0V	0	10					125		nA		
		V _{IO} =0V, V _{OI} =10V	0	10					-125				
		V _{IO} =18V, V _{OI} =0V	0	18		250			250	1000			
		V _{IO} =0V, V _{OI} =18V	0	18		-250			-250	-1000			
I _{DD}	Quiescent supply current	V _I (C _{IN})=V _{DD} , V _{SS}	0	5		1			1		7.5		
			0	10		2			2		15		
			0	15		4			4		30		
I _{IH}	"H" Input current (C _{IN})	V _I =18V	0	18		0.3			0.3		1.0		
I _{IL}	"L" Input current (C _{IN})	V _I =0V	0	18		-0.3			-0.3		-1.0		

M4066BP M4066BFP

6249826 MITSUBISHI ELEK (LINEAR)

QUADRUPLE BILATERAL SWITCH
80C 09119 D 7-51-11

SWITCHING CHARACTERISTICS (T_a=25°C)

Symbol	Parameter	Test conditions	Limits			Unit		
			V _{SS} (V)	V _{DD} (V)	Min		Typ	Max
f _{max(I/O)}	Maximum transfer frequency	R _L =10kΩ C _L =15pF Test circuit 2	-5	5		25		MHz
f _{max(C_{IN})}	Maximum control frequency	R _L =300Ω C _L =15pF Test circuit 3	0	5		6		MHz
t _{PLH}	"L-H" and "H-L" output propagation time (IN/OUT-OUT/IN)	R _L =10kΩ C _L =50pF Test circuit 4	0	5			45	ns
			0	10			30	
			0	15			20	
t _{PHL}			0	5			45	ns
			0	10			30	
			0	15			20	
t _{PLH}	"L-H" and "H-L" output propagation time (CONTROL IN-OUT/IN)	R _L =10kΩ C _L =50pF Test circuit 5	0	5			200	ns
			0	10			70	
			0	15			60	
t _{PHL}			0	5			200	ns
			0	10			70	
			0	15			60	
—	Sine-wave distortion	R _L =10kΩ f _i =1kHz Test circuit 2	-5	5		0.07		%
—	Feedthrough (switch off)	R _L =1kΩ Test circuit 6	-5	5		500		kHz
—	Crosstalk (CONTROL IN-OUT/IN)	R _L =1kΩ R _L =10kΩ C _L =15pF Test circuit 7	0	5			200	mV
			0	10			300	
			0	15			400	
C _i	Input capacitance	Control Input					7.5	pF
		Switch Input/output					10	

TEST CIRCUITS

1 ON resistance (R_{ON})

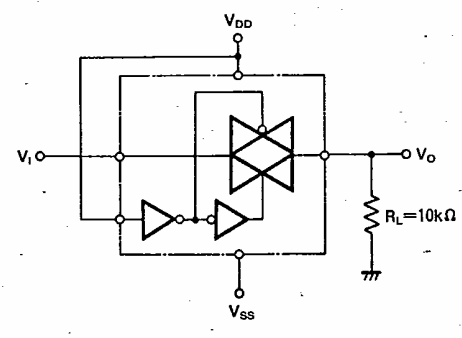

$$R_{ON} = 10 \times \frac{(V_I - V_O)}{V_O} \text{ (k}\Omega\text{)}$$

**2 Maximum transfer frequency (f_{max(I/O)})
Sine-wave distortion**

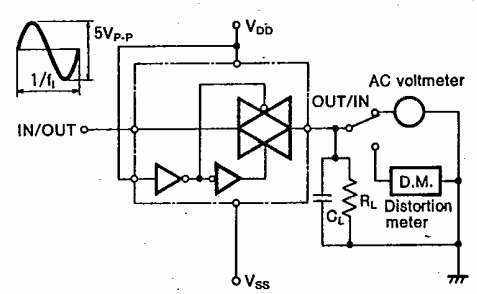

f_{max(I/O)} is taken as that frequency f_i at which, using a sine-wave input of 2.5V_{p-p}, 20 log₁₀(V_O/V_I) = -3dB.

M4066BP M4066BFP

QUADRUPLE BILATERAL SWITCH

5249826 MITSUBISHI ELEK (LINEAR)

80C 09120 D 7-51-11

3 Maximum control frequency ($f_{max}(C_{IN})$)

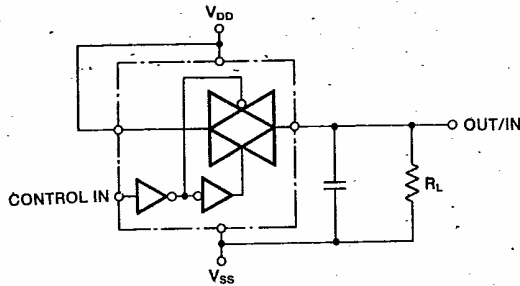

TIMING DIAGRAM

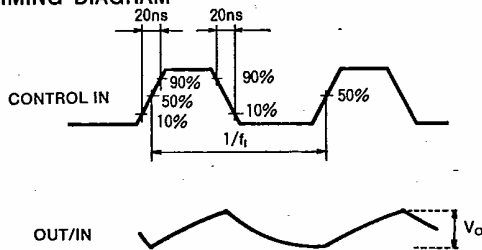

$f_{max}(C_{IN})$ is taken as that frequency f_i at which the output amplitude (V_o) is 1/2 that at 1kHz.

4 "L-H" and "H-L" output propagation time (IN/OUT-OUT/IN)

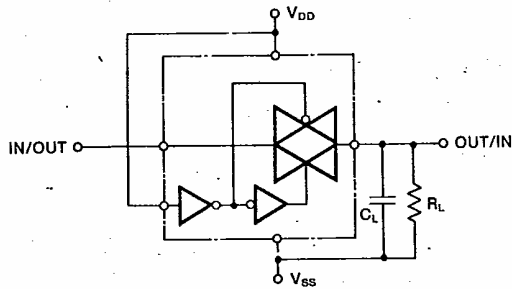

TIMING DIAGRAM

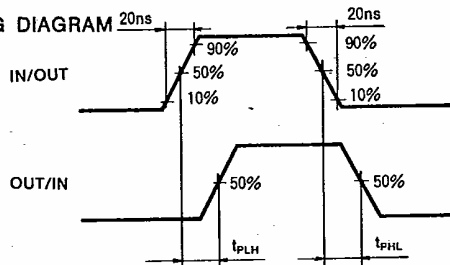

5 "L-H" and "H-L" output propagation time (CONTROL IN-OUT/IN)

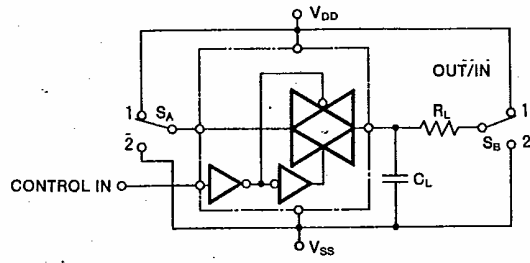

$S_A=1, S_B=2$

$S_A=2, S_B=1$

TIMING DIAGRAM

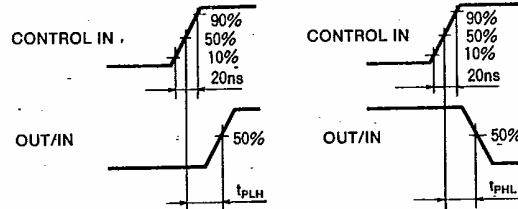

6 Feedthrough

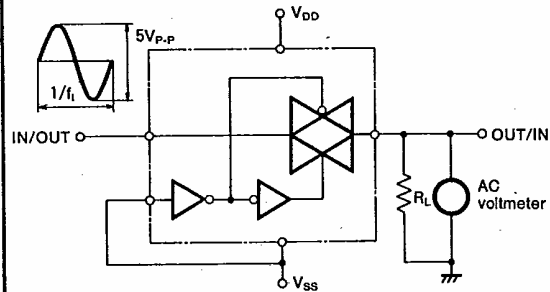

The feedthrough is taken as that frequency f_i at which, using a sine-wave input of $2.5V_{P-P}$, $20 \log_{10}(V_o/V_i) = -50dB$.

7 Crosstalk

