

GJ41C

NPN EPITAXIAL PLANAR TRANSISTOR

Description

The GJ41C is designed for use in general purpose amplifier and switching applications.

Features

*Complementary to GJ42C

Package Dimensions

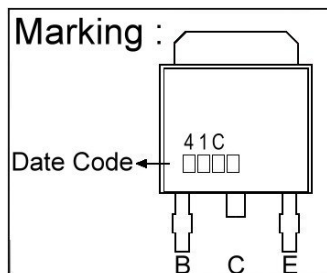
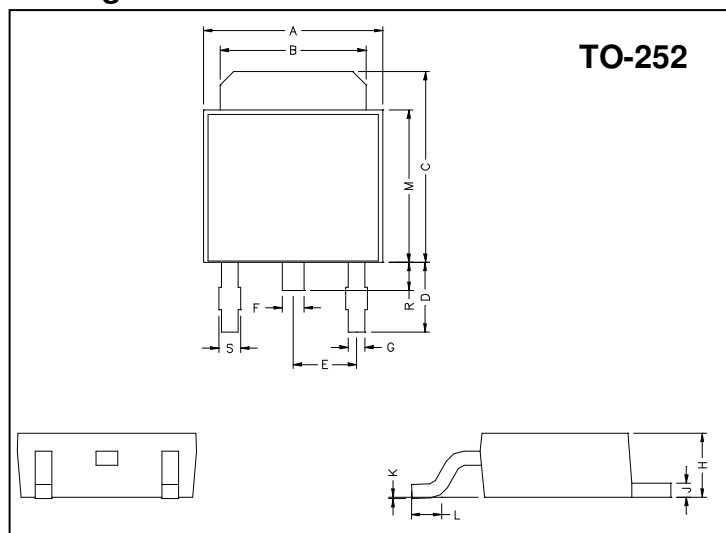

REF.	Millimeter		REF.	Millimeter	
	Min.	Max.		Min.	Max.
A	6.40	6.80	G	0.50	0.70
B	5.20	5.50	H	2.20	2.40
C	6.80	7.20	J	0.45	0.55
D	2.40	3.00	K	0	0.15
E	2.30 REF.		L	0.90	1.50
F	0.70	0.90	M	5.40	5.80
S	0.60	0.90	R	0.80	1.20

Absolute Maximum Ratings (Ta = 25°C, unless otherwise specified)

Parameter	Symbol	Ratings	Unit
Collector to Base Voltage	V _{CBO}	100	V
Collector to Emitter Voltage	V _{CEO}	100	V
Emitter to Base Voltage	V _{EBO}	5	V
Collector Current (DC)	I _C	6	A
Collector Current (Pulse)	I _C	10	A
Junction Temperature	T _j	+150	°C
Storage Temperature	T _{STG}	-55 ~ +150	°C
Total Power Dissipation	P _D	2	W
	P _D (T _C =25°C)	20	W

Electrical Characteristics (Rating at Ta=25°C)

Symbol	Min.	Typ.	Max.	Unit	Test Conditions
V _{CBO}	100	-	-	V	I _C =1mA, I _E =0
V _{CEO}	100	-	-	V	I _C =30mA, I _B =0
V _{EBO}	5	-	-	V	I _E =1mA, I _C =0
I _{CES}	-	-	10	uA	V _{CE} =100V, V _{EB} =0V
I _{CEO}	-	-	50	uA	V _{CE} =60V, I _B =0
I _{EBO}	-	-	500	uA	V _{EB} =5V, I _C =0
*V _{CE(sat)}	-	-	1.5	V	I _C =6A, I _B =600mA
*V _{BE(on)}	-	-	2.0	V	V _{CE} =4V, I _C =6A
*h _{FE1}	30	-	-		V _{CE} =4V, I _C =300mA
*h _{FE2}	15	-	75		V _{CE} =4V, I _C =3A
f _T	3	-	-	MHz	V _{CE} =10V, I _C =500mA, f=1MHz

* Pulse Test: Pulse Width ≤ 380μs, Duty Cycle ≤ 2%

Characteristics Curve

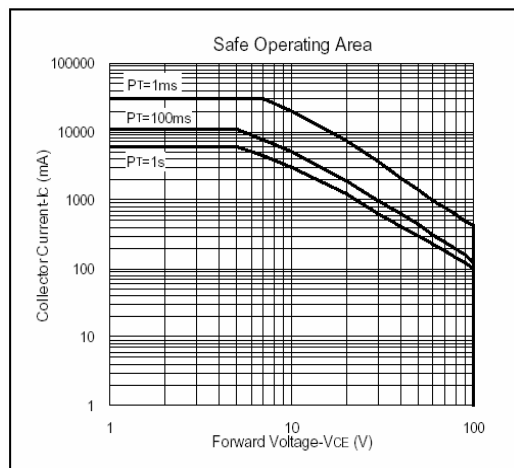
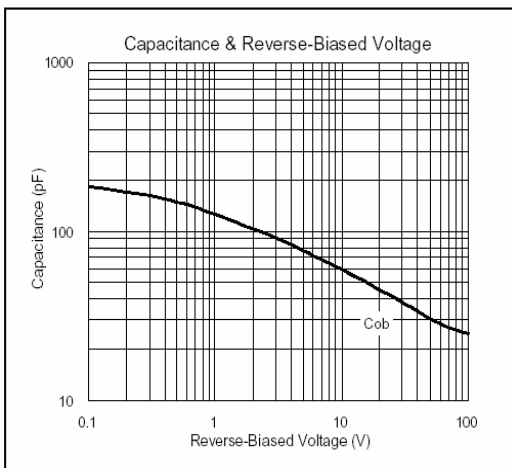
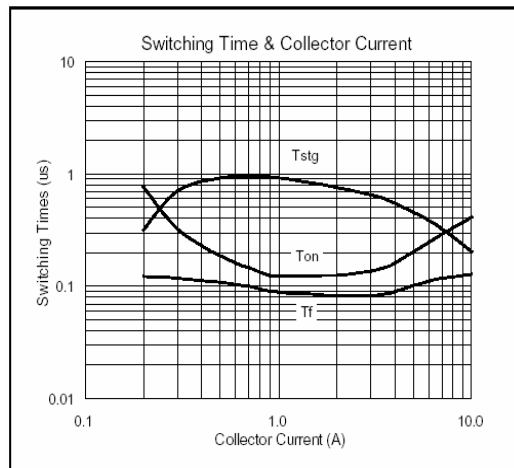
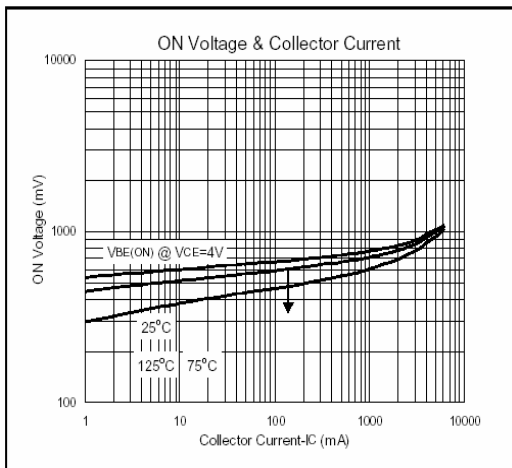
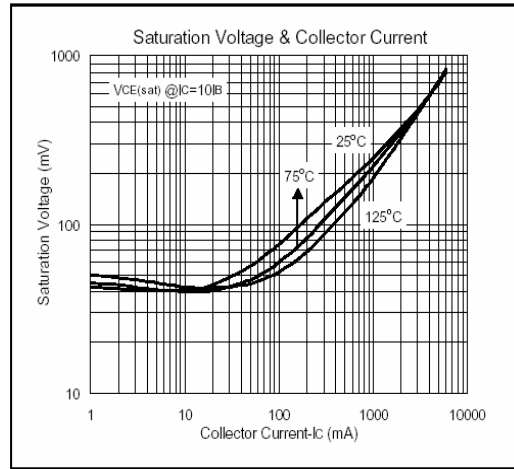
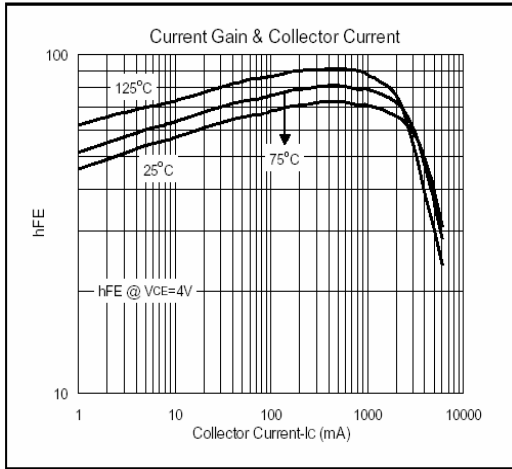

Important Notice:

- All rights are reserved. Reproduction in whole or in part is prohibited without the prior written approval of GTM.
- GTM reserves the right to make changes to its products without notice.
- GTM semiconductor products are not warranted to be suitable for use in life-support Applications, or systems.
- GTM assumes no liability for any consequence of customer product design, infringement of patents, or application assistance.

Head Office And Factory:

- **Taiwan:** No. 17-1 Tatung Rd. Fu Kou Hsin-Chu Industrial Park, Hsin-Chu, Taiwan, R. O. C.
- TEL : 886-3-597-7061 FAX : 886-3-597-9220, 597-0785
- **China:** (201203) No.255, Jang-Jiang Tsai-Lueng RD. , Pu-Dung-Hsin District, Shang-Hai City, China
- TEL : 86-21-5895-7671 FAX : 86-21-38950165