



# NPN Silicon Low Noise Transistor

The MRF1047T1 is fabricated utilizing Motorola's latest 12 GHz  $f_t$  discrete bipolar silicon process. The minimum noise figure is 1.0 dB at  $V_{CE} = 3.0$  V and  $I_C = 3.0$  mA. The noise performance of the MRF1047T1 at low bias makes this device the ideal choice in high gain, low noise applications. This device is well suited for low-voltage, low-current, front-end applications, for use in pagers, cellular and cordless phones, and other portable wireless systems.

The MRF1047T1 has 16 emitter fingers, with self-aligned and enhanced processing, resulting in a high  $f_t$ , low operating current transistor with reduced parasitics. The MRF1047T1 is fully-ion implanted with gold metallization and nitride passivation for maximum device reliability, performance and uniformity.

- Low Noise Figure,  $NF_{min} = 1.0$  dB (Typ) @ 1.0 GHz, 3.0 V and 3.0 mA
- High Current Gain-Bandwidth Product,  $f_t = 12$  GHz, 3.0 V @ 15 mA
- Maximum Stable Gain, 17 dB @ 1.0 GHz, 3.0 V and 10 mA
- Output Third Order Intercept,  $OIP_3 = 26$  dBm @ 1.0 GHz 3.0 V and 15 mA
- Fully Ion-Implanted with Gold Metallization and Nitride Passivation

## MAXIMUM RATINGS

Rating	Symbol	Value	Unit
Collector-Emitter Voltage	$V_{CEO}$	5.0	Vdc
Collector-Base Voltage	$V_{CBO}$	12	Vdc
Emitter-Base Voltage	$V_{EBO}$	2.5	Vdc
Collector Current – Continuous [Note 3]	$I_C$	45	mA
Power Dissipation @ $T_C = 75^\circ\text{C}$ Derate Linearly above $T_C = 75^\circ\text{C}$ at	$P_{D(max)}$	0.172 2.3	W mW/°C
Storage Temperature Range	$T_{stg}$	-55 to 150	°C
Maximum Junction Temperature	$T_{J(max)}$	150	°C

**NOTES:** 1. Meets Human Body Model (HBM)  $\leq 300$  V and Machine Model (MM)  $\leq 75$  V.  
2. ESD data available upon request.  
3. For MTBF >10 years.

## THERMAL CHARACTERISTIC

Characteristics	Symbol	Max	Unit
Thermal Resistance, Junction-to-Case	$R_{\theta JC}$	435	°C/W

**NOTE:** To calculate the junction temperature use  $T_J = (P_D \times R_{\theta JC}) + T_C$ . The case temperature measured on collector lead adjacent to the package body.

Order this document by MRF1047T1/D

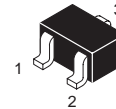
# MRF1047T1

## RF NPN SILICON TRANSISTOR

$f_t = 12$  GHz  
 $NF_{min} = 1.0$  dB  
 $I_{CMAX} = 45$  mA  
 $V_{CEO} = 5.0$  V

## SEMICONDUCTOR TECHNICAL DATA

Pin 1. Base  
2. Emitter  
3. Collector



PLASTIC PACKAGE  
CASE 419  
(SC-70, Tape & Reel Only)

## ORDERING INFORMATION

Device	Marking	Package
MRF1047T1	WB	SC-70 Tape & Reel*

\*3,000 Units per 8 mm, 7 inch reel.

LIFETIME BUY

LAST SHIP: 26MAR02  
LAST ORDER: 03AUG01

# MRF1047T1

## ELECTRICAL CHARACTERISTICS (T<sub>C</sub> = 25°C, unless otherwise noted)

Characteristic	Symbol	Min	Typ	Max	Unit
<b>OFF CHARACTERISTICS</b> [Note 1]					
Collector–Emitter Breakdown Voltage (I <sub>C</sub> = 0.1 mA, I <sub>B</sub> = 0)	V <sub>(BR)CEO</sub>	5.0	–	–	Vdc
Collector–Base Breakdown Voltage (I <sub>C</sub> = 0.1 mA, I <sub>E</sub> = 0)	V <sub>(BR)CBO</sub>	12	–	–	Vdc
Emitter–Base Breakdown Voltage (I <sub>E</sub> = 0.1 mA, I <sub>C</sub> = 0)	V <sub>(BR)EBO</sub>	2.5	–	–	Vdc
Collector Cutoff Current (V <sub>CB</sub> = 1.0 V, I <sub>E</sub> = 0)	I <sub>CBO</sub>	–	–	0.2	μA
Emitter Cutoff Current (V <sub>EB</sub> = 1.0 V, I <sub>C</sub> = 0)	I <sub>EBO</sub>	–	–	0.1	μA
<b>ON CHARACTERISTICS</b> [Note 1]					
DC Current Gain (V <sub>CE</sub> = 3.0 V, I <sub>C</sub> = 3.0 mA)	h <sub>FE</sub>	100	–	300	–
<b>DYNAMIC CHARACTERISTICS</b>					
Collector–Base Capacitance (V <sub>CB</sub> = 1.0 Vdc, I <sub>E</sub> = 0, f = 1.0 MHz)	C <sub>cb</sub>	–	0.4	–	pF
Current–Gain Bandwidth Product (V <sub>CE</sub> = 3.0 Vdc, I <sub>C</sub> = 15 mA, f = 1.0 GHz)	f <sub>t</sub>	–	12	–	GHz
<b>PERFORMANCE CHARACTERISTICS</b>					
Insertion Gain V <sub>CE</sub> = 1.0 V, I <sub>C</sub> = 1.0 mA, f = 1.0 GHz V <sub>CE</sub> = 3.0 V, I <sub>C</sub> = 3.0 mA, f = 1.0 GHz	S <sub>21</sub>   <sup>2</sup>	– –	8.0 13	– –	dB
Maximum Stable Gain and/or Maximum Available Gain [Note 2] V <sub>CE</sub> = 1.0 V, I <sub>C</sub> = 1.0 mA, f = 1.0 GHz V <sub>CE</sub> = 3.0 V, I <sub>C</sub> = 3.0 mA, f = 1.0 GHz	MSG, MAG	– –	11 16	– –	dB
Minimum Noise Figure V <sub>CE</sub> = 1.0 V, I <sub>C</sub> = 1.0 mA, f = 1.0 GHz V <sub>CE</sub> = 3.0 V, I <sub>C</sub> = 3.0 mA, f = 1.0 GHz	NF <sub>min</sub>	– –	1.2 1.0	– –	dB
Associated Gain at Minimum NF V <sub>CE</sub> = 1.0 V, I <sub>C</sub> = 1.0 mA, f = 1.0 GHz V <sub>CE</sub> = 3.0 V, I <sub>C</sub> = 3.0 mA, f = 1.0 GHz	G <sub>NF</sub>	– –	10 13	– –	dB
Output Power at 1.0 dB Gain Compression [Note 3] (V <sub>CE</sub> = 3.0 V, I <sub>C</sub> = 3.0 mA, f = 1.0 GHz)	P <sub>1dB</sub>	–	0.5	–	dBm
Output Third Order Intercept [Note 3] (V <sub>CE</sub> = 3.0 V, I <sub>C</sub> = 3.0 mA, f = 1.0 GHz)	OIP <sub>3</sub>	–	22	–	dBm

**NOTES:** 1. Pulse width ≤300 μs, duty cycle ≤2% pulsed.

2. Maximum Available Gain and Maximum Stable Gain are defined by the K factor as follows:

$$\text{MAG} = \left| \frac{S_{21}}{S_{12}} \left( K \pm \sqrt{K^2 - 1} \right) \right|, \text{ if } K > 1, \text{ MSG} = \left| \frac{S_{21}}{S_{12}} \right|, \text{ if } K < 1$$

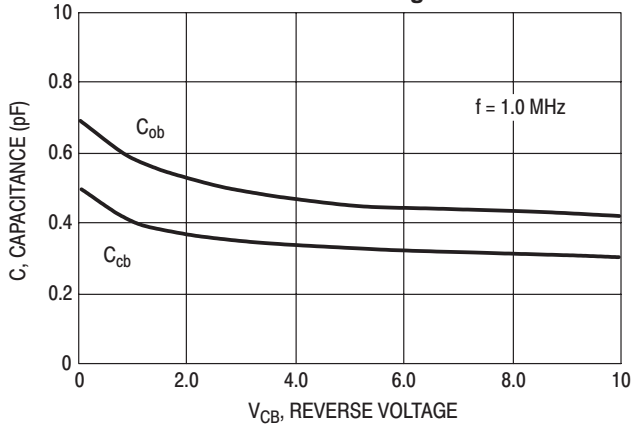
3. Z<sub>in</sub> = 50 Ω and Z<sub>out</sub> matched for optimum IP3.

LIFETIME BUY

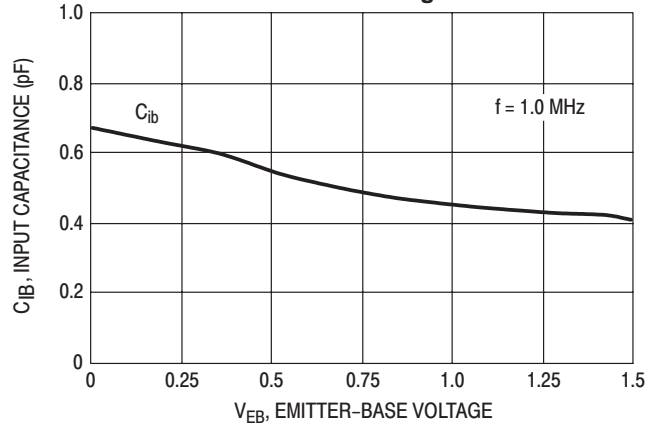
LAST SHIP: 26MAR02  
LAST ORDER: 03AUG01

# MRF1047T1

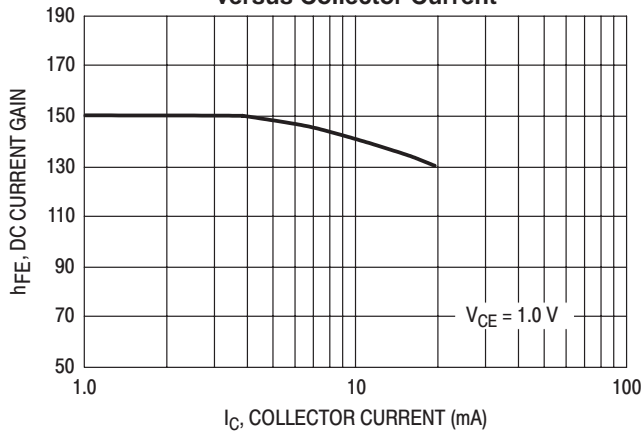
**Figure 1. Capacitance versus Voltage**



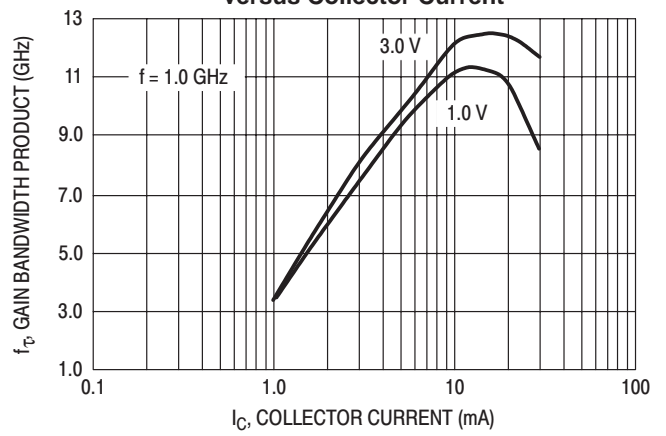
**Figure 2. Input Capacitance versus Voltage**



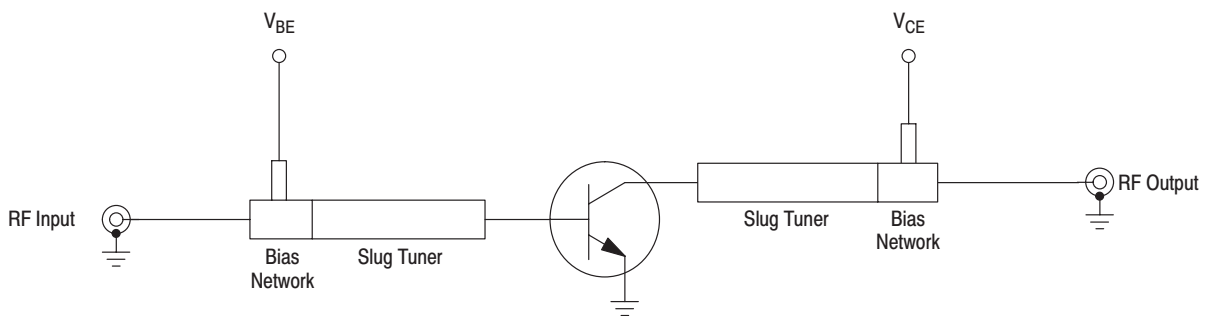
**Figure 3. DC Current Gain versus Collector Current**



**Figure 4. Gain-Bandwidth Product versus Collector Current**

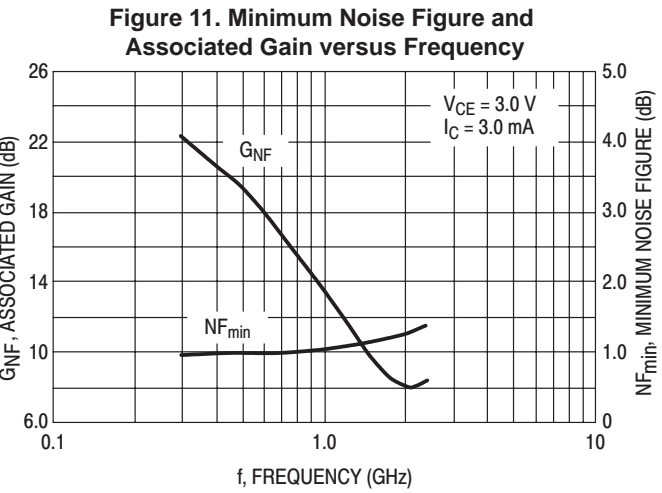
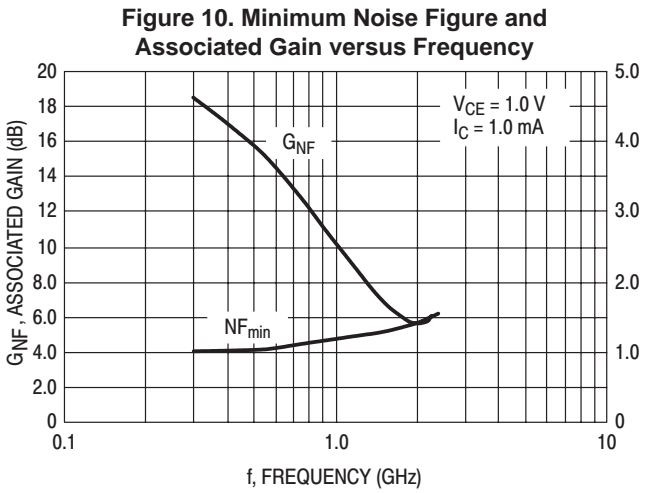
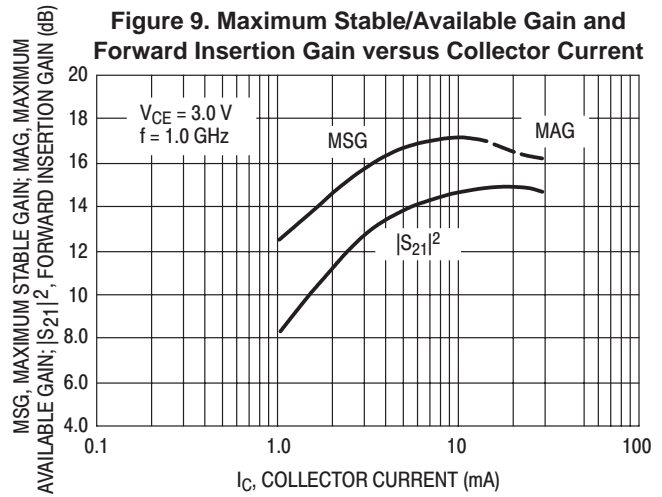
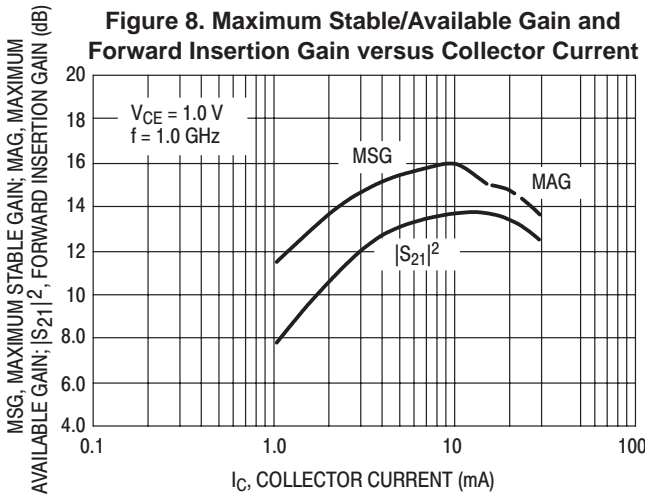
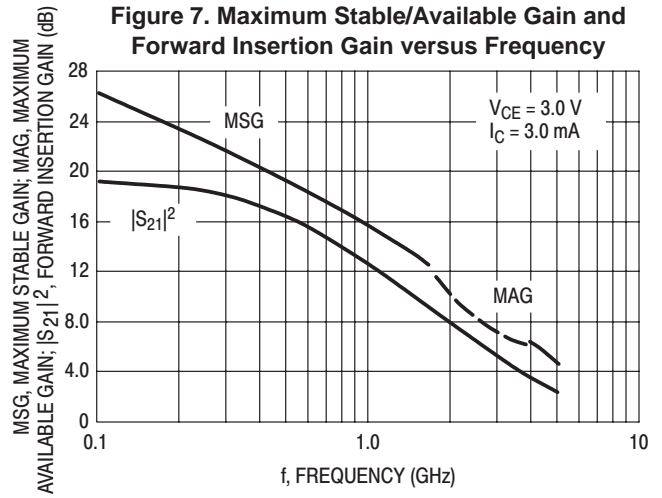
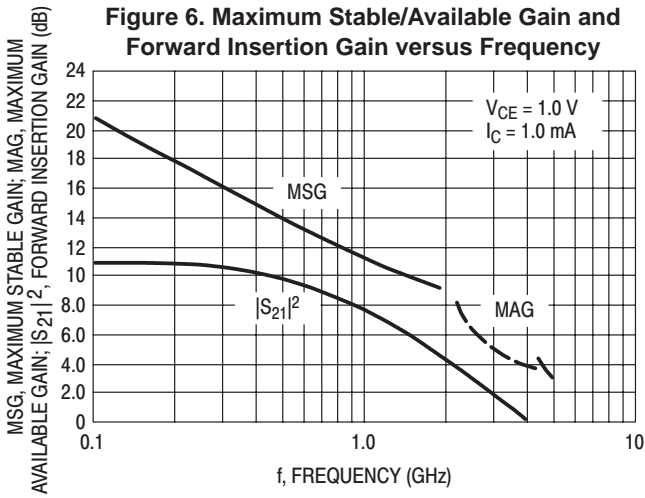


**Figure 5. Functional Circuit Schematic**



LIFETIME BUY

LAST SHIP: 26MAR02  
LAST ORDER: 03AUG01

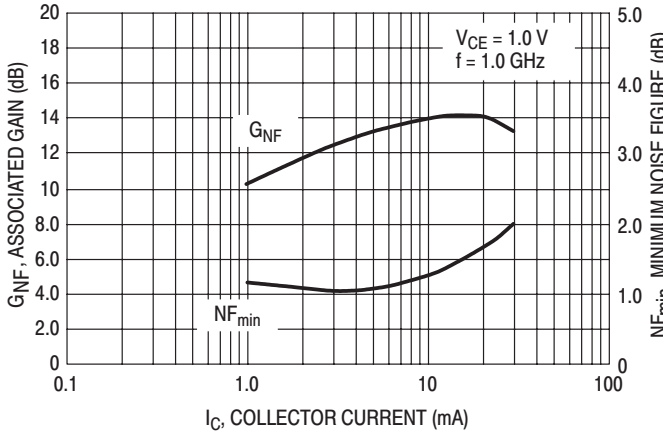


LIFETIME BUY

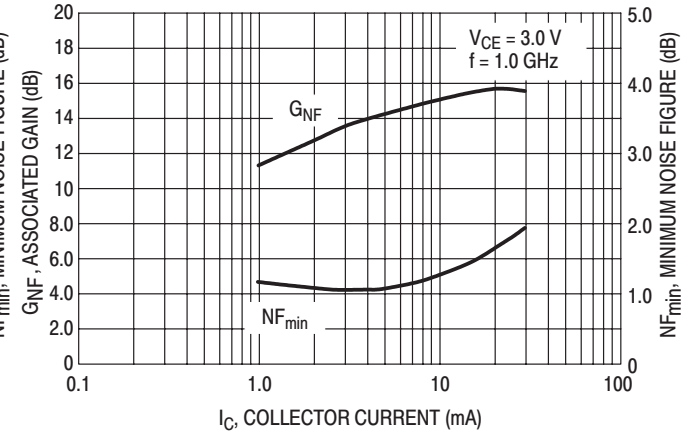
LAST SHIP: 26MAR02  
LAST ORDER: 03AUG01

# MRF1047T1

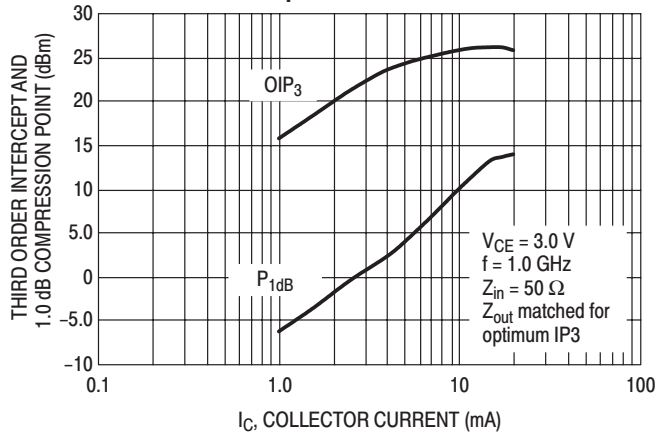
**Figure 12. Minimum Noise Figure and Associated Gain versus Collector Current**



**Figure 13. Minimum Noise Figure and Associated Gain versus Collector Current**



**Figure 14. Output Third Order Intercept and Output Power at 1.0 dB Gain Compression versus Collector Current**



LIFETIME BUY

LAST SHIP: 26MAR02  
LAST ORDER: 03AUG01

# MRF1047T1

Table 1. Common Emitter S-Parameters

V <sub>CE</sub> (Vdc)	I <sub>c</sub> (mA)	f (GHz)	S <sub>11</sub>		S <sub>21</sub>		S <sub>12</sub>		S <sub>22</sub>		K	
			S <sub>11</sub>	∠ φ	S <sub>21</sub>	∠ φ	S <sub>12</sub>	∠ φ	S <sub>22</sub>	∠ φ		
1.0	1.0	0.1	0.973	-10	3.49	171	0.029	84	0.987	-6	0.04	
		0.3	0.938	-30	3.35	154	0.082	72	0.952	-17	0.12	
		0.5	0.875	-48	3.03	137	0.124	60	0.877	-25	0.27	
		0.7	0.770	-64	2.75	124	0.153	51	0.812	-33	0.36	
		0.9	0.685	-79	2.51	112	0.174	45	0.745	-39	0.45	
		1.0	0.649	-85	2.40	107	0.181	42	0.717	-42	0.49	
		1.3	0.555	-105	2.09	92	0.195	36	0.639	-48	0.64	
		1.5	0.509	-117	1.92	84	0.202	33	0.601	-53	0.72	
		1.8	0.454	-136	1.72	72	0.204	30	0.553	-58	0.85	
		2.0	0.434	-148	1.59	66	0.205	30	0.531	-62	0.92	
		2.5	0.417	-175	1.38	50	0.208	32	0.477	-73	1.09	
		3.0	0.403	164	1.23	39	0.227	37	0.457	-83	1.14	
		3.5	0.416	142	1.10	28	0.259	41	0.454	-93	1.12	
	4.0	0.442	125	1.00	20	0.310	43	0.448	-105	1.05		
	4.5	0.454	109	0.95	12	0.378	41	0.433	-118	0.99		
	5.0	0.478	96	0.89	6	0.445	37	0.437	-133	0.95		
	3.0	3.0	0.1	0.917	-17	9.30	165	0.028	80	0.955	-11	0.10
			0.3	0.792	-48	7.94	140	0.072	65	0.831	-29	0.26
			0.5	0.630	-69	6.31	121	0.098	56	0.674	-39	0.47
			0.7	0.505	-87	5.11	107	0.116	51	0.571	-45	0.62
			0.9	0.418	-103	4.26	97	0.131	50	0.498	-49	0.74
			1.0	0.388	-110	3.93	93	0.138	49	0.471	-50	0.78
			1.3	0.317	-129	3.20	82	0.158	49	0.406	-54	0.91
			1.5	0.289	-142	2.84	76	0.172	48	0.380	-58	0.96
			1.8	0.265	-161	2.45	67	0.192	48	0.346	-62	1.02
			2.0	0.260	-173	2.24	61	0.206	48	0.329	-65	1.05
			2.5	0.282	164	1.88	49	0.244	47	0.284	-76	1.07
			3.0	0.283	147	1.65	39	0.287	45	0.271	-85	1.07
			3.5	0.306	128	1.47	30	0.330	42	0.269	-95	1.04
			4.0	0.334	115	1.34	21	0.374	38	0.262	-107	1.02
			4.5	0.354	103	1.25	13	0.423	34	0.256	-119	0.99
			5.0	0.382	93	1.176	6	0.470	29	0.260	-133	0.97
			5.0	5.0	0.1	0.861	-23	13.74	160	0.027	78	0.923
0.3	0.671	-59			10.50	130	0.064	63	0.727	-36	0.38	
0.5	0.489	-81			7.68	112	0.085	57	0.552	-44	0.62	
0.7	0.379	-100			5.95	100	0.103	56	0.455	-48	0.77	
0.9	0.311	-115			4.82	92	0.119	55	0.393	-50	0.87	
1.0	0.289	-122			4.41	88	0.128	55	0.372	-51	0.90	
1.3	0.241	-143			3.53	78	0.153	55	0.323	-54	0.98	
1.5	0.223	-155			3.11	72	0.171	55	0.303	-57	1.01	
1.8	0.214	-175			2.66	65	0.197	54	0.277	-62	1.04	
2.0	0.217	174			2.43	60	0.215	53	0.263	-65	1.05	
2.5	0.251	154			2.03	49	0.260	50	0.222	-77	1.06	
3.0	0.256	138			1.77	39	0.306	46	0.213	-86	1.05	
3.5	0.282	122			1.58	30	0.351	42	0.212	-97	1.03	
4.0	0.310	110			1.44	22	0.395	37	0.205	-111	1.01	
4.5	0.330	100			1.34	14	0.440	32	0.202	-123	1.00	
5.0	0.360	91			1.26	7	0.483	27	0.206	-138	0.98	
3.0	3.0	0.1			0.926	-13	9.03	167	0.021	82	0.967	-8
		0.3	0.820	-37	7.99	145	0.056	70	0.877	-22	0.26	
		0.5	0.673	-55	6.60	126	0.079	61	0.750	-30	0.48	
		0.7	0.541	-69	5.47	113	0.096	57	0.663	-34	0.62	
		0.9	0.441	-80	4.63	103	0.110	56	0.595	-38	0.73	
		1.0	0.402	-85	4.30	99	0.117	55	0.571	-39	0.78	
		1.3	0.308	-100	3.53	87	0.136	55	0.512	-42	0.90	
		1.5	0.262	-109	3.16	81	0.149	54	0.485	-45	0.95	
		1.8	0.208	-126	2.73	72	0.169	54	0.453	-48	1.01	
		2.0	0.185	-139	2.50	67	0.183	54	0.436	-51	1.03	
		2.5	0.176	-172	2.11	55	0.219	52	0.389	-59	1.06	
		3.0	0.160	165	1.85	45	0.259	51	0.379	-66	1.05	

LIFETIME BUY

LAST ORDER: 03AUG01 LAST SHIP: 26MAR02

# MRF1047T1

Table 1. Common Emitter S-Parameters (continued)

V <sub>CE</sub> (Vdc)	I <sub>C</sub> (mA)	f (GHz)	S <sub>11</sub>		S <sub>21</sub>		S <sub>12</sub>		S <sub>22</sub>		K
			S <sub>11</sub>	∠ φ	S <sub>21</sub>	∠ φ	S <sub>12</sub>	∠ φ	S <sub>22</sub>	∠ φ	
		3.5	0.177	137	1.65	35	0.301	48	0.374	-74	1.03
		4.0	0.208	120	1.50	27	0.346	45	0.363	-84	1.00
		4.5	0.228	106	1.40	19	0.395	41	0.354	-93	0.97
		5.0	0.261	96	1.32	11	0.444	37	0.353	-105	0.94
	5.0	0.1	0.884	-19	13.66	162	0.020	80	0.941	-12	0.14
		0.3	0.713	-49	10.92	135	0.052	67	0.786	-28	0.37
		0.5	0.529	-68	8.25	116	0.071	61	0.632	-34	0.61
		0.7	0.406	-83	6.48	104	0.086	59	0.546	-37	0.75
		0.9	0.324	-95	5.31	95	0.101	59	0.489	-38	0.85
		1.0	0.293	-101	4.87	92	0.108	59	0.470	-39	0.89
		1.3	0.223	-118	3.90	82	0.131	59	0.426	-41	0.97
		1.5	0.192	-129	3.45	76	0.146	59	0.406	-44	1.00
		1.8	0.163	-149	2.96	68	0.169	58	0.383	-47	1.03
		2.0	0.155	-163	2.70	64	0.185	57	0.369	-49	1.04
		2.5	0.176	168	2.25	53	0.226	55	0.327	-58	1.05
		3.0	0.174	149	1.96	43	0.269	52	0.321	-65	1.03
		3.5	0.198	128	1.74	34	0.311	48	0.317	-74	1.01
		4.0	0.229	115	1.59	26	0.355	44	0.306	-84	0.99
		4.5	0.249	104	1.47	18	0.400	40	0.299	-93	0.97
		5.0	0.279	95	1.38	11	0.446	35	0.297	-105	0.94
	10.0	0.1	0.781	-27	21.48	155	0.019	77	0.886	-17	0.25
		0.3	0.530	-62	14.32	123	0.045	66	0.648	-33	0.56
		0.5	0.350	-79	9.81	106	0.062	65	0.504	-35	0.80
		0.7	0.257	-92	7.38	96	0.078	66	0.439	-35	0.91
		0.9	0.198	-105	5.90	89	0.096	66	0.401	-35	0.96
		1.0	0.179	-110	5.37	86	0.105	66	0.389	-36	0.98
		1.3	0.133	-128	4.24	78	0.131	65	0.362	-37	1.02
		1.5	0.114	-142	3.73	73	0.149	64	0.348	-40	1.03
		1.8	0.104	-166	3.18	66	0.176	62	0.331	-43	1.03
		2.0	0.106	178	2.90	62	0.194	61	0.320	-46	1.04
		2.5	0.144	154	2.41	52	0.239	57	0.280	-55	1.03
		3.0	0.149	137	2.09	43	0.284	53	0.276	-62	1.02
		3.5	0.176	118	1.85	35	0.327	48	0.273	-72	1.00
		4.0	0.208	108	1.69	27	0.370	43	0.260	-82	0.99
		4.5	0.228	99	1.56	19	0.414	39	0.253	-92	0.97
		5.0	0.257	91	1.47	12	0.457	34	0.250	-104	0.95

LIFETIME BUY

LAST ORDER: 03AUG01 LAST SHIP: 26MAR02

# MRF1047T1

Table 2. Common-Emitter Noise Parameters

V <sub>CE</sub> (Vdc)	I <sub>c</sub> (mA)	f (GHz)	NF <sub>min</sub> (dB)	Γ <sub>O</sub>		R <sub>N</sub> Ω	r <sub>n</sub>	G <sub>NF</sub> (dB)	K	
				Magnitude	Angle					
1.0	1.0	0.3	1.00	0.67	15	28	0.55	18.6	0.12	
		0.5	1.04	0.64	25	26	0.52	15.8	0.27	
		0.7	1.08	0.61	35	25	0.49	13.3	0.36	
		0.9	1.13	0.59	46	23	0.46	11.2	0.45	
		1.0	1.16	0.57	51	22	0.44	10.2	0.49	
		1.5	1.28	0.52	81	16	0.33	6.8	0.72	
		2.0	1.41	0.48	116	10	0.20	5.5	0.92	
		2.4	1.52	0.47	146	6.0	0.12	6.0	1.07	
	3.0	0.3	0.83	0.56	14	17	0.34	20.9	0.26	
		0.5	0.88	0.52	23	16	0.32	18.0	0.47	
		0.7	0.94	0.48	32	15	0.30	15.5	0.62	
		0.9	0.99	0.45	42	14	0.29	13.3	0.74	
		1.0	1.02	0.43	47	14	0.28	12.4	0.78	
		1.5	1.16	0.38	79	11	0.22	8.7	0.96	
		2.0	1.31	0.35	117	8.0	0.15	7.1	1.05	
		2.4	1.44	0.35	152	5.0	0.10	7.3	1.07	
	5.0	0.3	0.90	0.48	13	15	0.29	21.6	0.38	
		0.5	0.94	0.44	21	14	0.28	18.8	0.62	
		0.7	0.98	0.40	31	13	0.26	16.3	0.77	
		0.9	1.03	0.36	42	12	0.25	14.1	0.87	
		1.0	1.06	0.35	48	12	0.24	13.1	0.90	
		1.5	1.20	0.30	82	10	0.19	9.4	1.01	
		2.0	1.37	0.28	123	7.0	0.14	7.7	1.05	
		2.4	1.53	0.30	161	5.0	0.11	7.7	1.06	
	3.0	1.0	0.3	1.11	0.67	14	31	0.62	19.7	0.11
			0.5	1.12	0.65	22	30	0.59	16.8	0.26
			0.7	1.13	0.64	31	28	0.56	14.3	0.35
			0.9	1.16	0.62	41	26	0.52	12.2	0.44
1.0			1.17	0.60	46	25	0.50	11.2	0.48	
1.5			1.26	0.56	74	19	0.38	7.7	0.70	
2.0			1.39	0.51	106	12	0.24	6.5	0.91	
2.4			1.51	0.47	135	7.0	0.15	7.0	1.05	
3.0		0.3	0.94	0.60	13	21	0.41	22.3	0.26	
		0.5	0.96	0.57	19	20	0.40	19.3	0.48	
		0.7	0.98	0.54	25	19	0.39	16.7	0.62	
		0.9	1.01	0.51	33	18	0.36	14.5	0.73	
		1.0	1.03	0.50	37	18	0.35	13.5	0.78	
		1.5	1.13	0.44	61	15	0.29	9.7	0.95	
		2.0	1.26	0.37	92	11	0.21	8.1	1.03	
		2.4	1.39	0.32	121	8.0	0.15	8.3	1.06	
5.0		0.3	0.92	0.53	13	17	0.34	22.8	0.37	
		0.5	0.95	0.49	20	16	0.32	19.9	0.61	
		0.7	0.99	0.46	28	16	0.31	17.4	0.75	
		0.9	1.03	0.43	37	15	0.29	15.2	0.85	
		1.0	1.06	0.42	42	14	0.28	14.2	0.89	
		1.5	1.20	0.36	72	12	0.23	10.4	1.00	
		2.0	1.36	0.32	109	8.0	0.17	8.7	1.04	
		2.4	1.53	0.30	144	6.0	0.12	8.8	1.05	
10.0		0.3	1.17	0.39	13	15	0.29	23.8	0.56	
		0.5	1.18	0.35	21	14	0.28	20.9	0.80	
		0.7	1.21	0.32	31	13	0.26	18.3	0.91	
		0.9	1.24	0.29	42	13	0.25	16.1	0.96	
		1.0	1.26	0.28	48	12	0.25	15.1	0.98	
		1.5	1.40	0.24	83	10	0.21	11.2	1.03	
		2.0	1.59	0.23	128	8.0	0.16	9.3	1.04	
		2.4	1.79	0.24	170	7.0	0.13	9.3	1.03	

LIFETIME BUY

LAST SHIP: 26MAR02  
LAST ORDER: 03AUG01

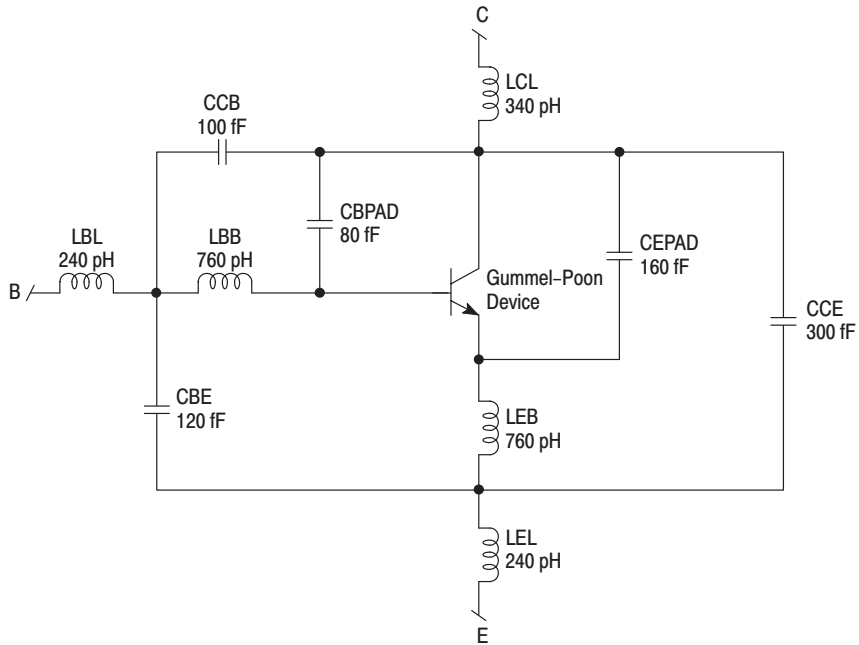


# MRF1047T1

**Table 3. Spice Parameters (MRF1047 Die Gummel-Poon Parameters)**

Name	Value	Name	Value	Name	Value
IS	5.8 E-16	IRB	7.50E-03	TF	1.50E-11
BF	180	RBM	4.0	XTF	8.0
NF	0.99	RE	1.0	VTF	4.2355
VAF	40	RC	7.0	ITF	0.2
IKF	0.18	XTB	0	PTF	60
ISE	3.140E-14	EG	1.11	TR	1.00E-09
NE	1.78	XTI	3.0	FC	0.95
BR	26.8	CJE	5.70E-13		
NR	0.9974	VJE	0.98		
VAR	2.0	MJE	0.5		
IKR	7.50E-03	CJC	4.00E-13		
ISC	2.200E-14	VJC	0.59		
NC	1.48	MJC	0.314		
RB	6.924	XCJC	0.6		

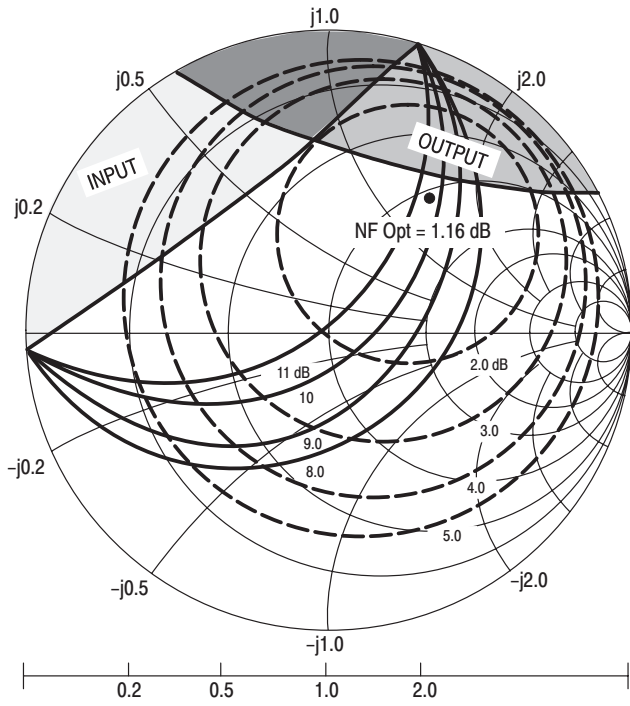
**Figure 15. MRF1047 SC-70 Package Equivalent Circuit**



LIFETIME BUY

LAST SHIP: 26MAR02  
LAST ORDER: 03AUG01

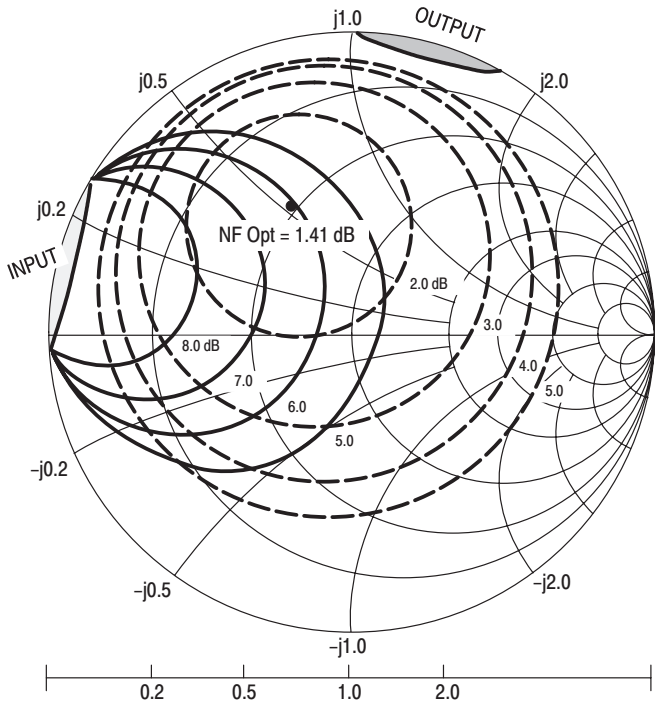
Figure 16. Constant Gain and Noise Figure Contours  
(f = 1.0 GHz)



$V_{CE} = 1.0\text{ V}$   
 $I_C = 1.0\text{ mA}$   
 □ — Potentially Unstable

f (GHz)	NF Opt (dB)	$\Gamma_o$	Rn	K
1.0	1.16	$0.57 \angle 51.3^\circ$	21.8	0.49

Figure 17. Constant Gain and Noise Figure Contours  
(f = 2.0 GHz)



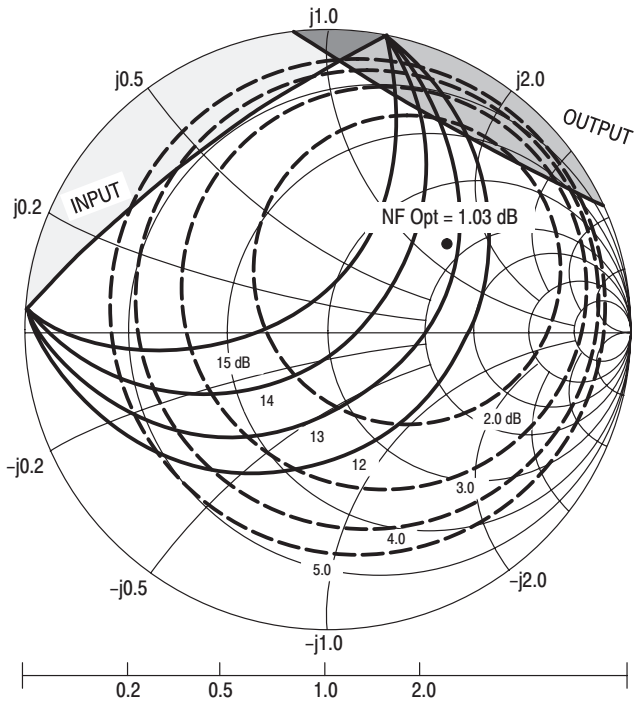
$V_{CE} = 1.0\text{ V}$   
 $I_C = 1.0\text{ mA}$   
 □ — Potentially Unstable

f (GHz)	NF Opt (dB)	$\Gamma_o$	Rn	K
2.0	1.41	$0.48 \angle 115.6^\circ$	9.8	0.92

LIFETIME BUY

LAST SHIP: 26MAR02  
 LAST ORDER: 03AUG01

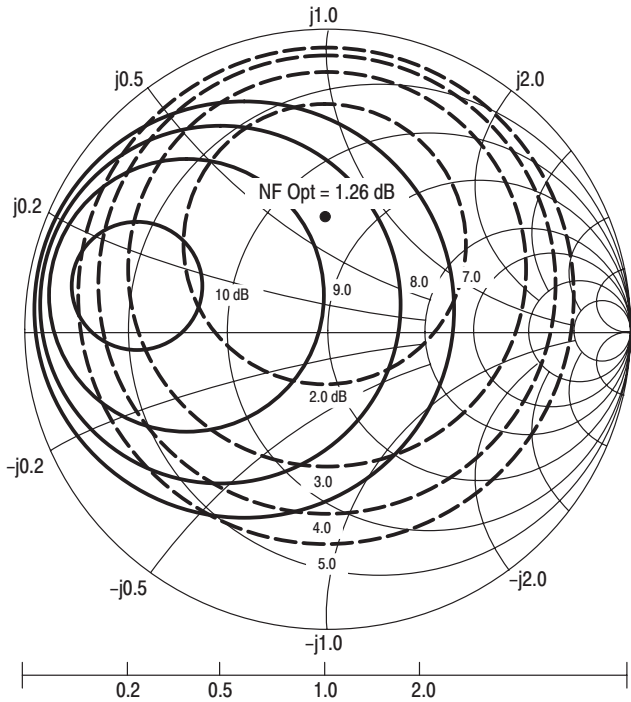
Figure 18. Constant Gain and Noise Figure Contours  
(f = 1.0 GHz)



$V_{CE} = 3.0\text{ V}$   
 $I_C = 3.0\text{ mA}$   
 □ — Potentially Unstable

f (GHz)	NF Opt (dB)	$\Gamma_o$	Rn	K
1.0	1.03	$0.50 \angle 37.1^\circ$	17.6	0.78

Figure 19. Constant Gain and Noise Figure Contours  
(f = 2.0 GHz)



$V_{CE} = 3.0\text{ V}$   
 $I_C = 3.0\text{ mA}$   
 □ — Potentially Unstable

f (GHz)	NF Opt (dB)	$\Gamma_o$	Rn	K
2.0	1.26	$0.37 \angle 91.7^\circ$	10.7	1.03

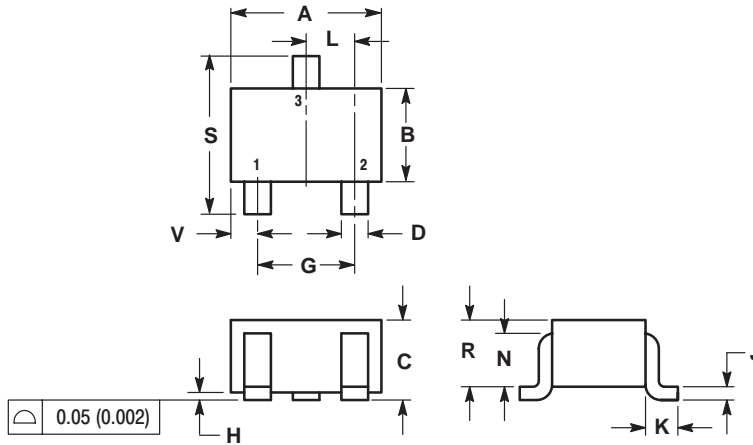
LIFETIME BUY

LAST SHIP: 26MAR02  
 LAST ORDER: 03AUG01

# MRF1047T1

## OUTLINE DIMENSIONS

PLASTIC PACKAGE  
CASE 419-02  
(SC-70)  
ISSUE J




- NOTES:  
1. DIMENSIONING AND TOLERANCING PER ANSI Y14.5M, 1982.  
2. CONTROLLING DIMENSION: INCH.

DIM	INCHES		MILLIMETERS	
	MIN	MAX	MIN	MAX
A	0.071	0.087	1.80	2.20
B	0.045	0.053	1.15	1.35
C	0.035	0.049	0.90	1.25
D	0.012	0.016	0.30	0.40
G	0.047	0.055	1.20	1.40
H	0.000	0.004	0.00	0.10
J	0.004	0.010	0.10	0.25
K	0.017 REF		0.425 REF	
L	0.026 BSC		0.650 BSC	
N	0.028 REF		0.700 REF	
R	0.031	0.039	0.80	1.00
S	0.079	0.087	2.00	2.20
V	0.012	0.016	0.30	0.40

LIFETIME BUY

LAST SHIP: 26MAR02

LAST ORDER: 03AUG01

Motorola reserves the right to make changes without further notice to any products herein. Motorola makes no warranty, representation or guarantee regarding the suitability of its products for any particular purpose, nor does Motorola assume any liability arising out of the application or use of any product or circuit, and specifically disclaims any and all liability, including without limitation consequential or incidental damages. "Typical" parameters which may be provided in Motorola data sheets and/or specifications can and do vary in different applications and actual performance may vary over time. All operating parameters, including "Typicals" must be validated for each customer application by customer's technical experts. Motorola does not convey any license under its patent rights nor the rights of others. Motorola products are not designed, intended, or authorized for use as components in systems intended for surgical implant into the body, or other applications intended to support or sustain life, or for any other application in which the failure of the Motorola product could create a situation where personal injury or death may occur. Should Buyer purchase or use Motorola products for any such unintended or unauthorized application, Buyer shall indemnify and hold Motorola and its officers, employees, subsidiaries, affiliates, and distributors harmless against all claims, costs, damages, and expenses, and reasonable attorney fees arising out of, directly or indirectly, any claim of personal injury or death associated with such unintended or unauthorized use, even if such claim alleges that Motorola was negligent regarding the design or manufacture of the part. Motorola and  are registered trademarks of Motorola, Inc. Motorola, Inc. is an Equal Opportunity/Affirmative Action Employer.

**How to reach us:**

**USA/EUROPE/Locations Not Listed:** Motorola Literature Distribution;  
P.O. Box 5405, Denver, Colorado 80217. 1-303-675-2140 or 1-800-441-2447

**JAPAN:** Motorola Japan Ltd.; SPS, Technical Information Center, 3-20-1,  
Minami-Azabu, Minato-ku, Tokyo 106-8573 Japan. 81-3-3440-3569

**Technical Information Center: 1-800-521-6274**

**ASIA/PACIFIC:** Motorola Semiconductors H.K. Ltd.; Silicon Harbour Centre,  
2, Dai King Street, Tai Po Industrial Estate, Tai Po, N.T., Hong Kong.  
852-26668334

**HOME PAGE:** <http://www.motorola.com/semiconductors/>

