

ML62 Series Positive Voltage Regulator

❖ Application

- ◆ Battery Powered Equipment
- ◆ Palmtops
- ◆ Portable Cameras and Video Recorders
- ◆ Reference Voltage Sources

❖ Features

- CMOS Low Power Consumption :
Typical 3.3uA at $V_{out}=5.0V$
- Output Voltage Range : 1.1V to 6.0V in 0.1V increments
- Highly Accurate:
Output Voltage $\pm 3\%$ for 1.1V to 1.9V
Output Voltage $\pm 2\%$ for 2.0V to 6.0V
- Maximum Output Current: 250mA
(within the maximum power dissipation, $V_{out}=5.0V$)
- Small Input-Output Voltage Differential:
0.12V at 100mA and 0.38V at 200mA
- Input stability: Typ. 0.2%/V
- Package Available:
SOT- 23 (150mW), SOT- 89 (500mW) &
TO - 92 (300mW)

❖ General Description

The ML62 is a group of positive voltage output, three-pin regulator which provides high output current even when the input/output voltage differential is small.

The ML62 consists of a high-precision voltage reference, an error correction circuit, and a current limited output driver.

❖ Block Diagram

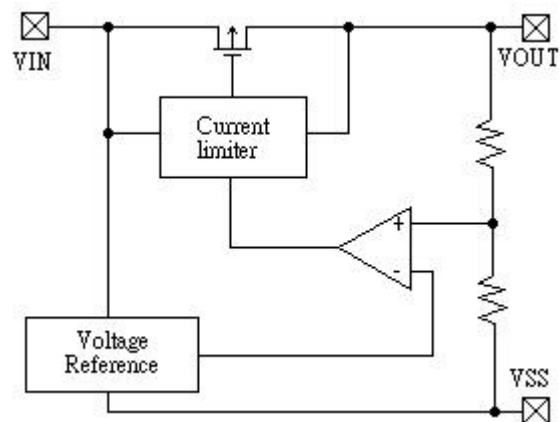

❖ Absolute Maximum Ratings

Parameter		Symbol	Ratings	Units
Input Voltage		V_{IN}	12	V
Output Current		I_{OUT}	500	mA
Output Voltage		V_{OUT}	$V_{SS}-0.3 \sim V_{IN}+0.3$	V
Continuous Total Power Dissipation	SOT-23	P_d	150	mW
	SOT-89		500	
	TO-92		300	
Operating Ambient Temperature		T_{opr}	-30 ~ +70	$^{\circ}C$
Storage Temperature		T_{stg}	-30 ~ +70	$^{\circ}C$

❖ **Pin Configuration**

SOT-23 :

Pin Number	Pin Name	Description
1	VSS	Ground
2	VOUT	Supply Voltage Output
3	VIN	Supply Voltage Input

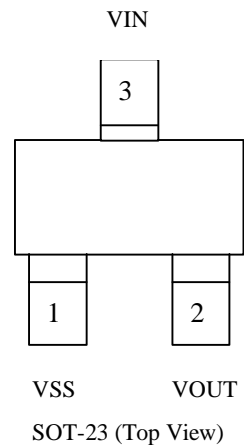

SOT-89 :

Pin Number	Pin Name	Description
1	VSS	Ground
2	VIN	Supply Voltage Input
3	VOUT	Supply Voltage Output

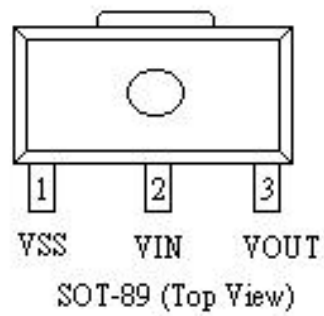

TO-92 :

Pin Number	Pin Name	Description
1	VSS	Ground
2	VIN	Supply Voltage Input
3	VOUT	Supply Voltage Output

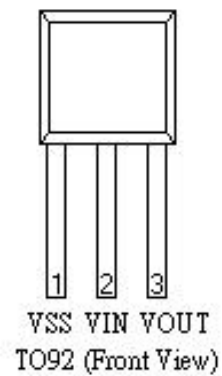

❖ **Standard Circuit**

Note on Use

- Oscillation may occur as a result of the impedance present between the power supply and the IC's input. Please use a capacitor (CIN) of at least 1uF, when the impedance is 10 ohm or more.
 With a large output current, Voltage output can be stabilised by increasing capacitor (CIN) size. If CIN is small and capacitor (CL) size is increased, oscillation may occur. In such cases, Voltage output can be stabilised by either increasing the size of CIN or decreasing the size of CL.
- Please ensure that output current (IOUT) is less than $P_d / (V_{IN} - V_{OUT})$ and does not exceed the stipulated Continuous Total Power Dissipation value (Pd).

❖ **Test Circuit**

Test Circuit 1

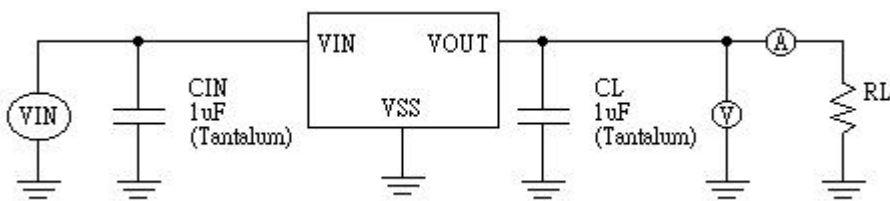

Test Circuit 2

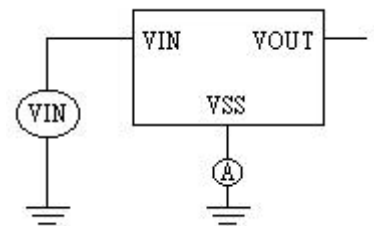

❖ Electrical Characteristics

ML62502 $V_{OUT}(T)=5.0V$ (Note 1)

Parameter	Symbol	Conditions	Min	Typ	Max	Units	Circuit
Output Voltage	$V_{OUT}(E)$ (Note 2)	$I_{OUT}=40mA$ $V_{IN}=6.0V$	4.900	5.000	5.100	V	1
Maximum Output Current	$I_{OUT\ max}$	$V_{IN}=6.0V, V_{OUT}(E) \approx 4.5V$	250			mA	1
Load Stability	DV_{OUT}	$V_{IN}=6.0V, 1mA \leq I_{OUT} \leq 100mA$		40	80	mV	1
Input -Output Voltage Differential (Note 3)	V_{dif1}	$I_{OUT}=100mA$		120	400	mV	1
	V_{dif2}	$I_{OUT}=200mA$		380	750	mV	1
Supply Current	ISS	$V_{IN}=6.0V$		3.3	4.5	μA	2
Input Stability	$\frac{DV_{OUT}}{DV_{IN} * V_{OUT}}$	$I_{OUT}=40mA$ $6.0V \leq V_{IN} \leq 10.0V$		0.2	0.3	%V	1
Input Voltage	V_{IN}				10	V	-

ML62402 $V_{OUT}(T)=4.0V$ (Note 1)

Parameter	Symbol	Conditions	Min	Typ	Max	Units	Circuit
Output Voltage	$V_{OUT}(E)$ (Note 2)	$I_{OUT}=40mA$ $V_{IN}=5.0V$	3.920	4.000	4.080	V	1
Maximum Output Current	$I_{OUT\ max}$	$V_{IN}=5.0V, V_{OUT}(E) \approx 3.6V$	200			mA	1
Load Stability	DV_{OUT}	$V_{IN}=5.0V, 1mA \leq I_{OUT} \leq 100mA$		45	90	mV	1
Input -Output Voltage Differential (Note 3)	V_{dif1}	$I_{OUT}=90mA$		170	400	mV	1
	V_{dif2}	$I_{OUT}=180mA$		400	750	mV	1
Supply Current	ISS	$V_{IN}=5.0V$		3.0	4.5	μA	2
Input Stability	$\frac{DV_{OUT}}{DV_{IN} * V_{OUT}}$	$I_{OUT}=40mA$ $5.0V \leq V_{IN} \leq 10.0V$		0.2	0.3	%V	1
Input Voltage	V_{IN}				10	V	-

ML62302 $V_{OUT}(T)=3.0V$ (Note 1)

Parameter	Symbol	Conditions	Min	Typ	Max	Units	Circuit
Output Voltage	$V_{OUT}(E)$ (Note 2)	$I_{OUT}=40mA$ $V_{IN}=4.0V$	2.940	3.000	3.060	V	1
Maximum Output Current	$I_{OUT\ max}$	$V_{IN}=4.0V, V_{OUT}(E) \approx 2.7V$	150			mA	1
Load Stability	DV_{OUT}	$V_{IN}=4.0V, 1mA \leq I_{OUT} \leq 80mA$		45	90	mV	1
Input -Output Voltage Differential (Note 3)	V_{dif1}	$I_{OUT}=80mA$		180	450	mV	1
	V_{dif2}	$I_{OUT}=150mA$		400	850	mV	1
Supply Current	ISS	$V_{IN}=4.0V$		2.8	4.5	μA	2
Input Stability	$\frac{DV_{OUT}}{DV_{IN} * V_{OUT}}$	$I_{OUT}=40mA$ $4.0V \leq V_{IN} \leq 10.0V$		0.2	0.3	%V	1
Input Voltage	V_{IN}				10	V	-

ML62202 $V_{OUT}(T)=2.0V$ (Note 1)

Parameter	Symbol	Conditions	Min	Typ	Max	Units	Circuit
Output Voltage	$V_{OUT}(E)$ (Note 2)	$I_{OUT}=40mA$ $V_{IN}=3.0V$	1.960	2.000	2.040	V	1
Maximum Output Current	$I_{OUT\ max}$	$V_{IN}=3.0V, V_{OUT}(E) \approx 1.8V$	100			mA	1
Load Stability	DV_{OUT}	$V_{IN}=3.0V, 1mA \leq I_{OUT} \leq 60mA$		45	90	mV	1
Input -Output Voltage Differential (Note 3)	V_{dif1}	$I_{OUT}=60mA$		180	450	mV	1
	V_{dif2}	$I_{OUT}=100mA$		400	850	mV	1
Supply Current	ISS	$V_{IN}=3.0V$		2.5	4.5	μA	2
Input Stability	$\frac{DV_{OUT}}{DV_{IN} * V_{OUT}}$	$I_{OUT}=40mA$ $3.0V \leq V_{IN} \leq 10.0V$		0.2	0.3	%V	1
Input Voltage	V_{IN}				10	V	-

- Note :
1. $V_{OUT}(T)$ = Specified Output Voltage.
 2. $V_{OUT}(E)$ = Effective Output Voltage (i.e. the output voltage when $(V_{OUT}(T)+1.0V)$ is provided at the V_{IN} pin while maintaining a certain I_{OUT} value).
 3. V_{dif} = V_{IN1} (Note 4) – $V_{OUT}(E)$
 4. V_{IN1} = The input voltage at the time 98% of $V_{OUT}(E)$ is output (input voltage has been gradually reduced).

❖ Electrical Characteristics by Output Voltage

Part Number	Output voltage				Max Output Current		Load Stability			I-O Voltage Differential		
	V _{OUT} (V)				I _{OUT max} (mA)		D V _{OUT} (mV)			V _{diff} (mV)		
	Conditions	MIN.	TYP.	MAX.	Conditions	MIN.	Conditions	TYP.	MAX.	Conditions	TYP.	MAX.
ML62113	I _{OUT} =40mA V _{IN} =V _{OUT} (T)+1V	1.067	1.100	1.133	V _{IN} =V _{OUT} (T)+1V V _{OUT} (E)≥ V _{OUT} (T)*0.9	80	V _{IN} =V _{OUT} (T)+1V 1mA<I _{OUT} <40mA	45	90	I _{OUT} =20mA	250	450
ML62123		1.164	1.200	1.236								
ML62133		1.261	1.300	1.339								
ML62143		1.358	1.400	1.442						I _{OUT} =30mA	250	450
ML62153		1.455	1.500	1.545								
ML62163		1.552	1.600	1.648								
ML62173		1.649	1.700	1.751						I _{OUT} =40mA	250	450
ML62183		1.746	1.800	1.854								
ML62193		1.843	1.900	1.957								
ML62202		1.960	2.000	2.040		100	V _{IN} =V _{OUT} (T)+1V 1mA≤I _{OUT} ≤60mA	45	90	I _{OUT} =60mA	180	450
ML62212		2.058	2.100	2.142								
ML62222		2.156	2.200	2.244								
ML62232		2.254	2.300	2.346								
ML62242		2.352	2.400	2.448								
ML62252		2.450	2.500	2.550								
ML62262		2.548	2.600	2.652								
ML62272		2.646	2.700	2.754								
ML62282		2.744	2.800	2.856								
ML62292		2.842	2.900	2.958		150	V _{IN} =V _{OUT} (T)+1V 1mA≤I _{OUT} ≤80mA	45	90	I _{OUT} =80mA	180	450
ML62302		2.940	3.000	3.060								
ML62312		3.038	3.100	3.162								
ML62322		3.136	3.200	3.264								
ML62332		3.234	3.300	3.366								
ML62342		3.332	3.400	3.468								
ML62352		3.430	3.500	3.570								
ML62362		3.528	3.600	3.672								
ML62372		3.626	3.700	3.774								
ML62382		3.724	3.800	3.876		200	V _{IN} =V _{OUT} (T)+1V 1mA≤I _{OUT} ≤100mA	45	90	I _{OUT} =90mA	170	400
ML62392		3.822	3.900	3.978								
ML62402		3.920	4.000	4.080								
ML62412		4.018	4.100	4.182								
ML62422		4.116	4.200	4.284								
ML62432		4.214	4.300	4.386								
ML62442	4.312	4.400	4.488									
ML62452	4.410	4.500	4.590									
ML62462	4.508	4.600	4.692									
ML62472	4.606	4.700	4.794	250	V _{IN} =V _{OUT} +1V 1mA≤I _{OUT} ≤100mA	40	80	I _{OUT} =100mA	120	400		
ML62482	4.704	4.800	4.896									
ML62492	4.802	4.900	4.998									
ML62502	4.900	5.000	5.100									
ML62512	4.998	5.100	5.202									
ML62522	5.096	5.200	5.304									
ML62532	5.194	5.300	5.406									
ML62542	5.292	5.400	5.508									
ML62552	5.390	5.500	5.610									
ML62562	5.488	5.600	5.712									
ML62572	5.586	5.700	5.814									
ML62582	5.684	5.800	5.916									
ML62592	5.782	5.900	6.018									
ML62602	5.880	6.000	6.120									

Part Number	I-O Voltage Differential			Supply Current			Input Stability			Input Voltage
	$V_{diff}(mV)$			$I_{SS}(uA)$			$D V_{OUT}/(D V_{IN} * V_{OUT}) (\%V)$			$V_{IN}(V)$
	Conditions	TYP.	MAX.	Conditions	TYP.	MAX.	Conditions	TYP.	MAX.	MAX.
ML62113	I _{OUT} =40mA	450	850	$V_{IN}=V_{OUT}(T)+1V$	2.0	4.5	I _{OUT} =40mA $V_{OUT}(T)+1V \leq V_{IN} \leq 10V$	0.2	0.4	12
ML62123										
ML62133										
ML62143										
ML62153										
ML62163										
ML62173										
ML62183										
ML62193										
ML62202										
ML62212										
ML62222										
ML62232										
ML62242										
ML62252										
ML62262										
ML62272										
ML62282										
ML62292										
ML62302										
ML62312										
ML62322										
ML62332										
ML62342										
ML62352										
ML62362										
ML62372										
ML62382										
ML62392										
ML62402										
ML62412										
ML62422										
ML62432										
ML62442										
ML62452										
ML62462										
ML62472										
ML62482										
ML62492										
ML62502										
ML62512										
ML62522										
ML62532										
ML62542										
ML62552										
ML62562										
ML62572										
ML62582										
ML62592										
ML62602										

❖ *Typical Performance Characteristics*

1) Output Voltage vs. Output Current

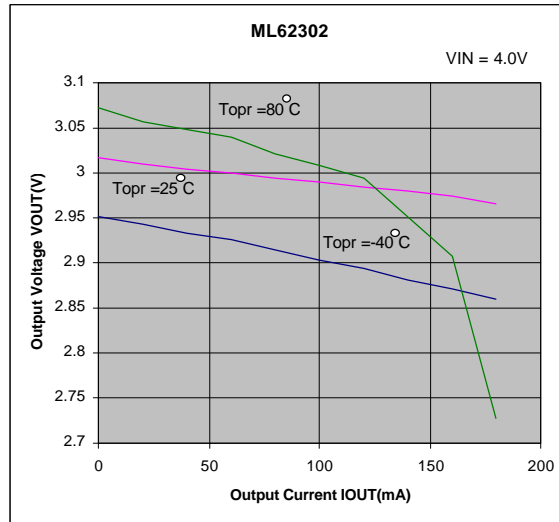
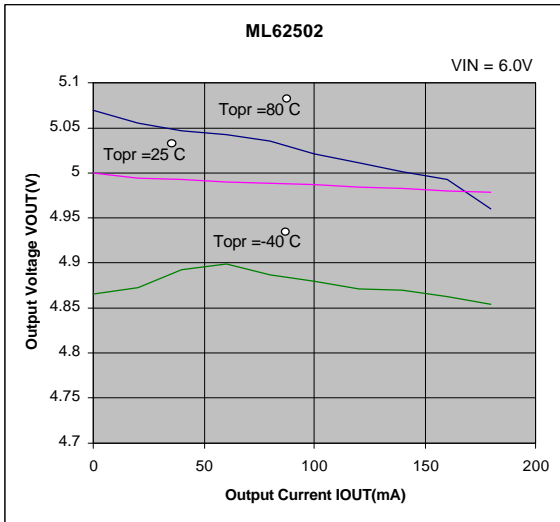

2) Output Voltage vs. Input Voltage

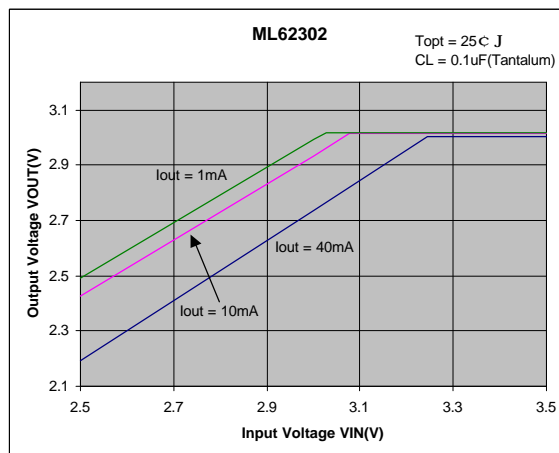
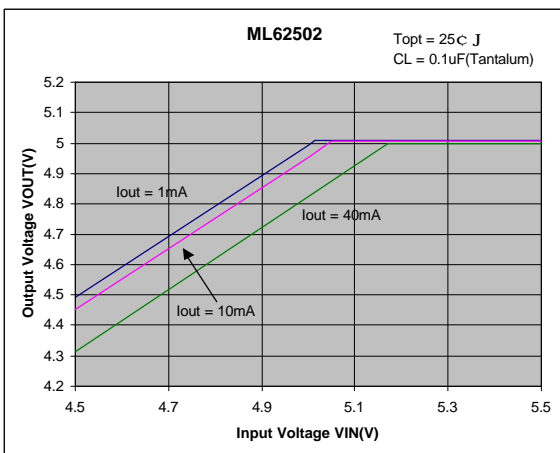

3) Input/Output Voltage Differential vs. Output Current

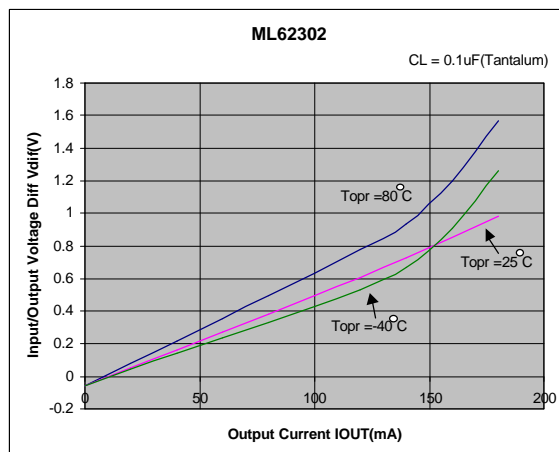
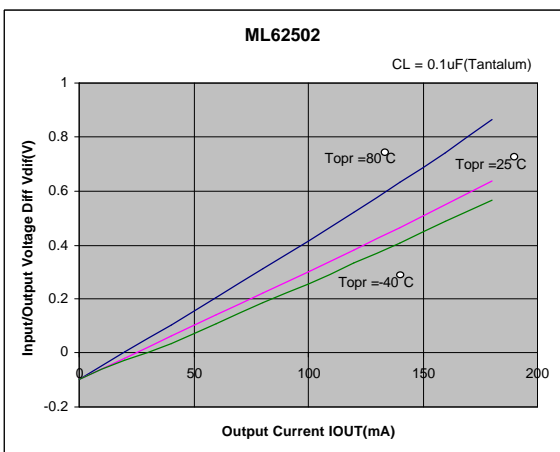

4) Supply Current vs. Input Voltage

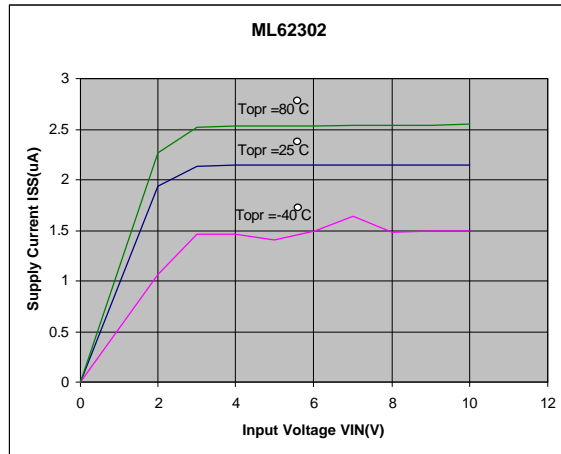
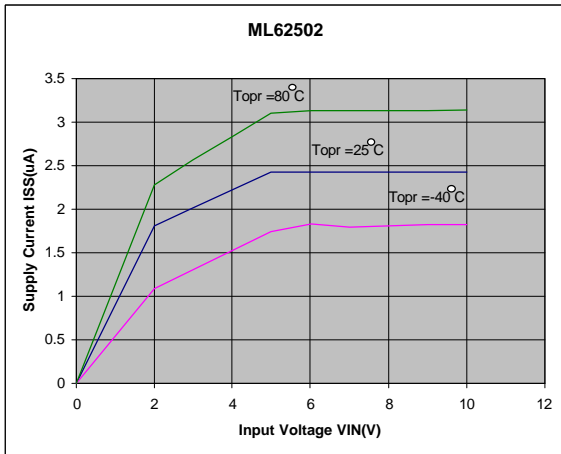

5) Output Voltage vs. Ambient Temperature

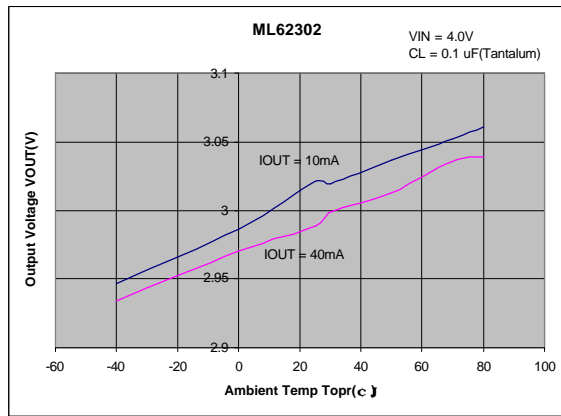
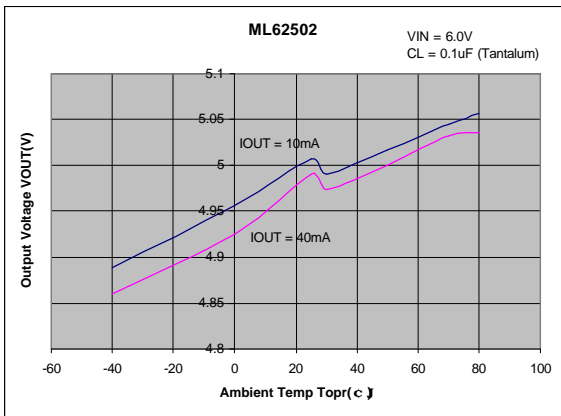

6) Supply Current vs. Ambient Temperature

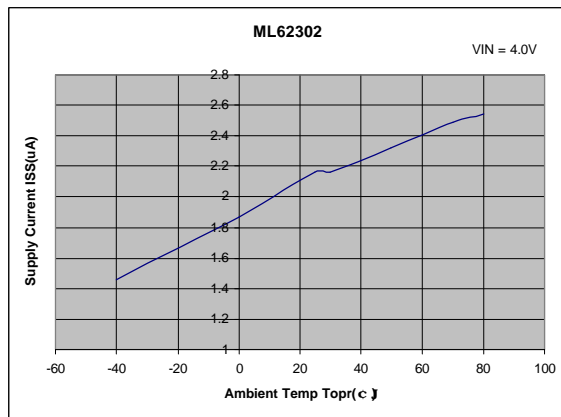
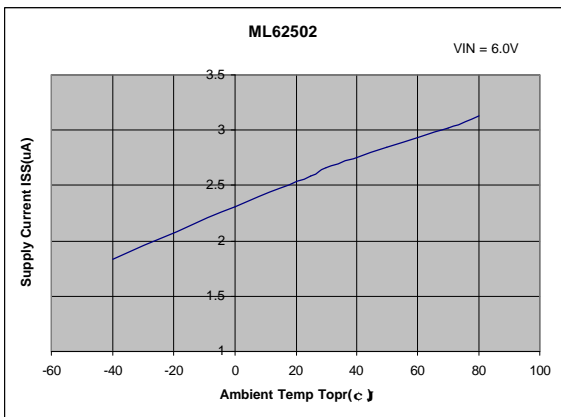

❖ **Ordering Information**

Designator	Description
a	Output Voltage eg. 30=3.0V 50=5.0V
b	Output Voltage Accuracy 2 = ± 2.0% 3 = ± 3.0%
c	Package Type M = SOT-23 P = SOT-89 T = TO-92
d	Device Orientation R = Embossed Tape (Orientation of Device : Right) L = Embossed Tape (Orientation of Device : Left) B = Bag (TO-92) H = Paper Tape (TO-92)

ML62xxxxx
 ††††
 a bcd

❖ **Marking**

SOT-23 :

Designator	Description
1	Type R = Positive Voltage Regulator
2,3	Output Voltage eg. 30 = 3.0V
4	Internal Code

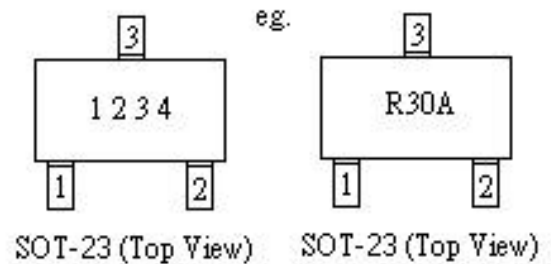

SOT-89 :

Designator	Description
1	Type R = Positive Voltage Regulator
2,3	Output Voltage eg. 30 = 3.0V
4	Output Voltage Accuracy 2 = ± 2.0% 3 = ± 3.0%
5	Internal Code

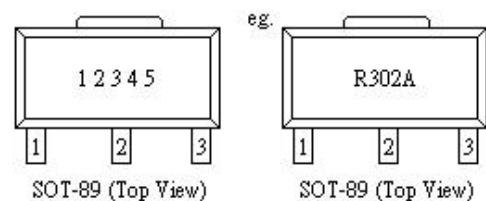

TO-92 :

Designator	Description
1	Type R = Positive Voltage Regulator
2,3	Output Voltage eg. 30 = 3.0V
4	Output Voltage Accuracy 2 = ± 2.0% 3 = ± 3.0%
5	Internal code
6, 7	Year Code eg. 00 = Year 2000
8, 9	Week Code eg. 10 = Week 10

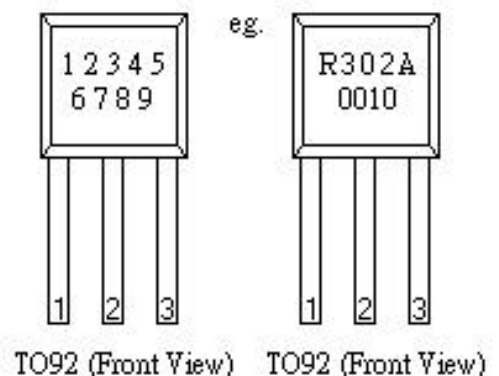

❖ **Packaging Information**

SOT-23 :

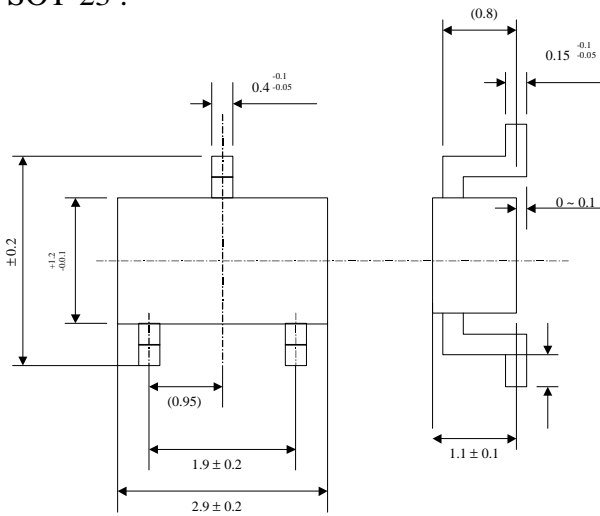

SOT-89 :

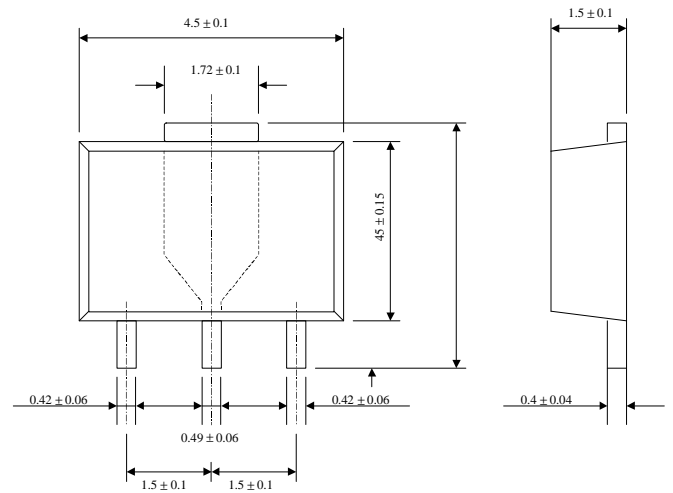

TO-92 :

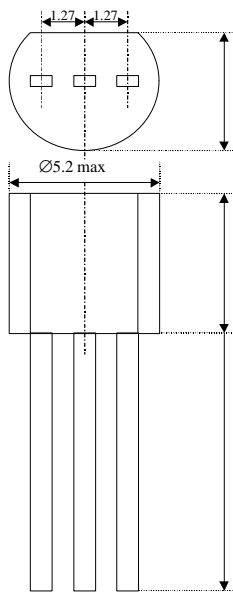

Units : mm

❖ **Recommended Pattern Layout**

SOT-23 :

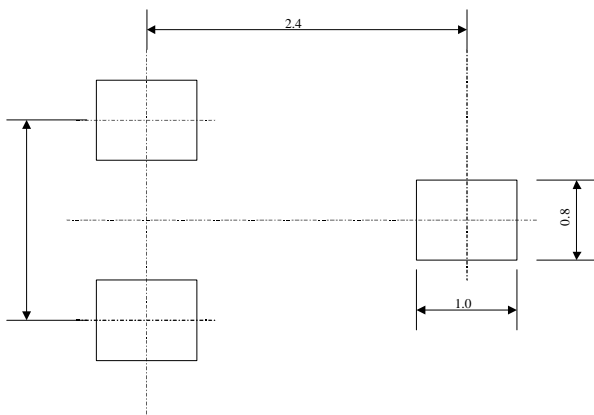

SOT-89 :

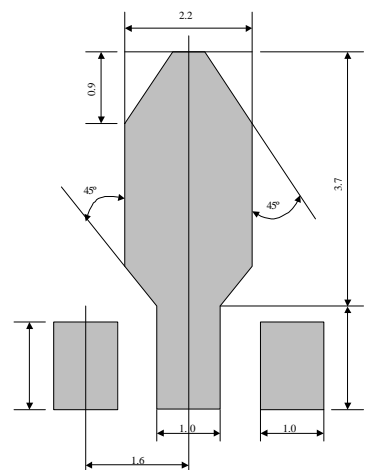

❖ **Tape and Reel Information**

SOT-23 :

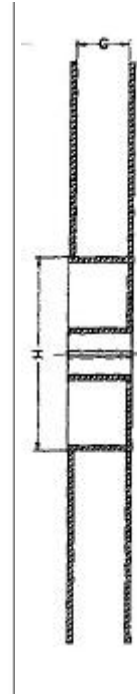
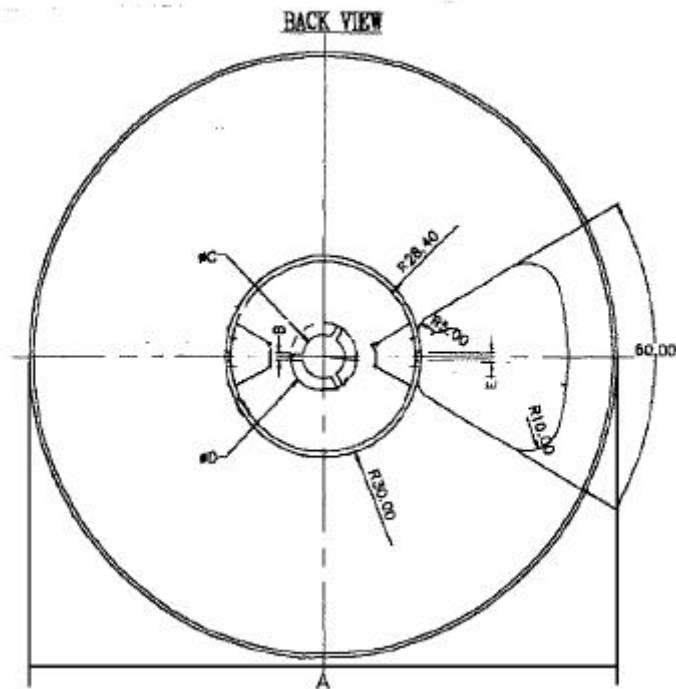

	SIZE (mm)
A	∅ 178 ± 0.8
B	2 ± 0.2
C	∅ 13 ± 0.2
D	∅ 21 ± 0.8
G	8 ± 0.5
H	∅ 60

3,000 pcs / reel

SOT-23 Taping Specifications :

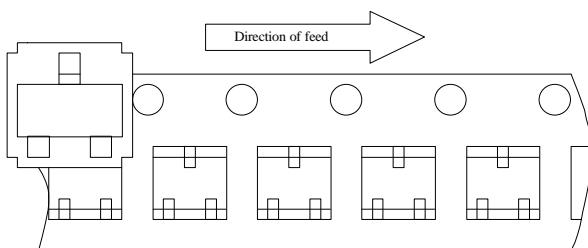
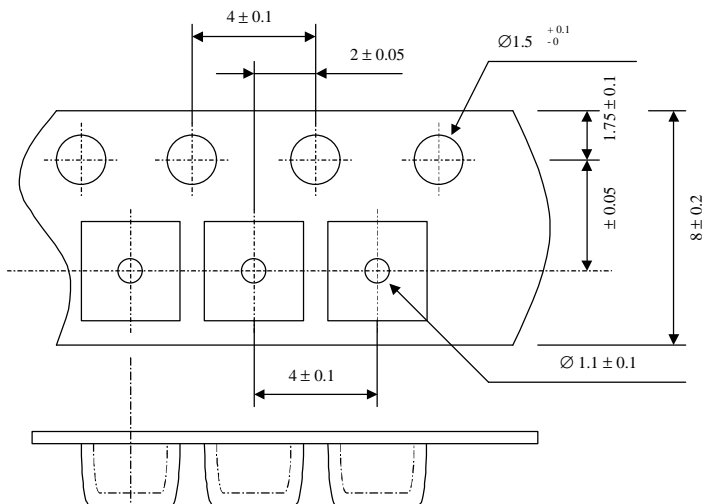

"R" type [Orientation of Device: Right]
Standard Type

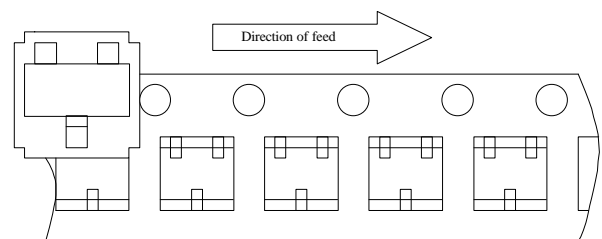

"L" type [Orientation of Device: Left]
Reverse Type

SOT-89 :

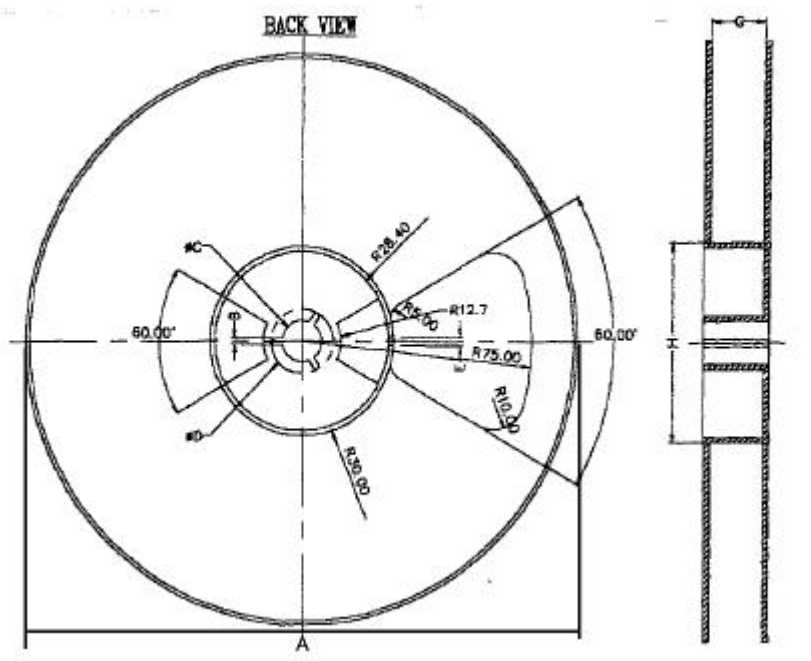

	SIZE (mm)
A	∅ 178 ± 0.8
B	2 ± 0.2
C	∅ 13 ± 0.2
D	∅ 21 ± 0.8
G	12 ± 0.5
H	∅ 60

1,000 pcs / reel

SOT-89 Taping Specifications :

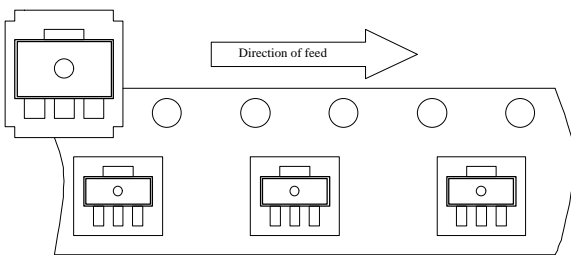
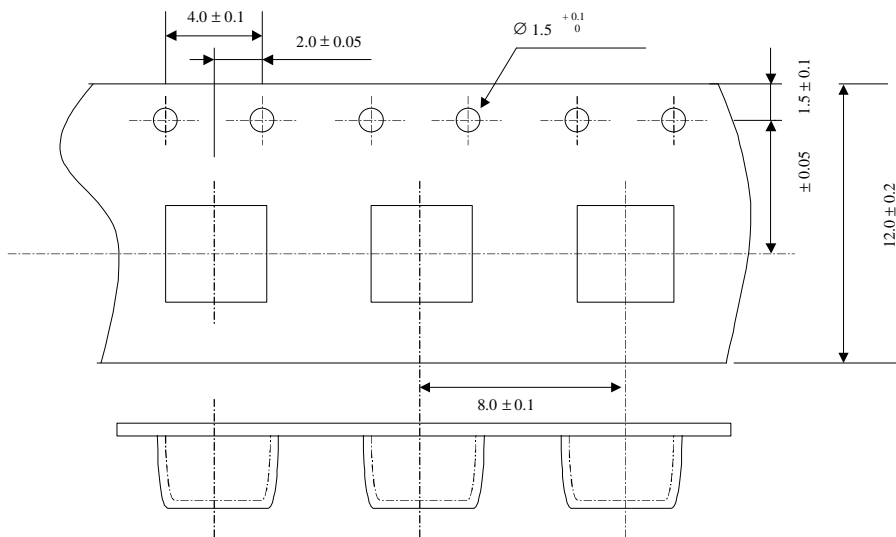

"R" type [Orientation of Device: Right]
Standard Type

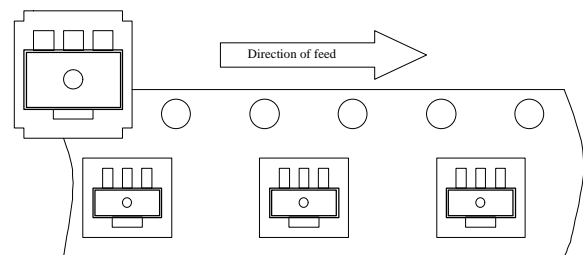

"L" type [Orientation of Device: Left]
Reverse Type

TO-92 Taping Specifications :

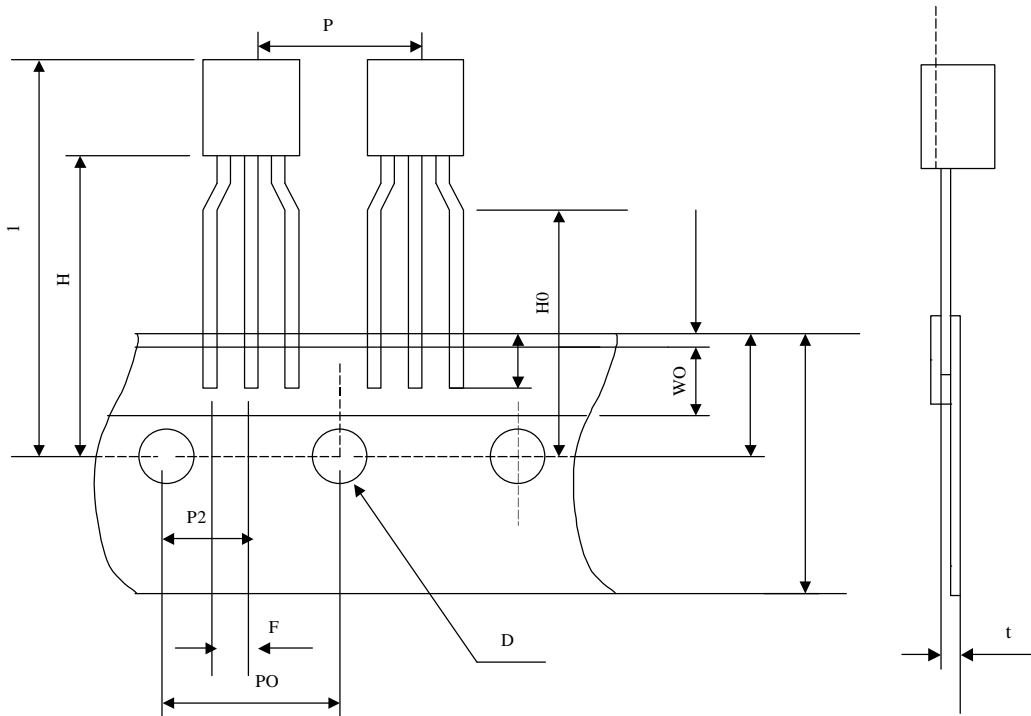

	SIZE (mm)
P	12.7 ± 1.0
PO	12.7 ± 0.3
P2	6.35 ± 0.4
F	2.5 ^{+0.45} _{-0.15}
W	18.0 ± 1.0
WO	6.0 ± 0.3
W1	9.0 ± 0.5
W2	0.5 MAX
H	19.0 ± 0.5
H0	16.0 ± 0.5
H1	32.25 MAX
D	∅ 4.0 ± 0.2
t	0.6 ± 0.2
L1	3.5 MIN

2,000 pcs / box

❖ *History of Revision*

REV	DESCRIPTION	DATE
	First Official Specification	04/04/01
A	SOT-23, SOT-89 & TO-92 Package and packing description added. Operating and Storage Temperature modified.	23/10/01
B	Absolute Maximum Input Rating of Input Voltage increased from 10V to 12V.	02/08/02
C	1.1V to 1.9V Voltage Regulator Added. Typical Performance Characteristics added.	24/10/02
D	Modify 1.1V to 1.9V Voltage Regulator Electrical Characteristics.	08/11/02
E	Modify 1.1V & 1.2V Voltage Regulator I-O Voltage Differential Characteristics.	23/12/02
F	Modify 1.3V to 1.6V Voltage Regulator I-O Voltage Differential Characteristics.	24/1/03



The information presented in this document does not form part of any quotation or contract, is believed to be accurate and reliable and may be changed without notice. No liability will be accepted by the publisher for any consequence of its use.