

# HOA1870

## Transmissive Sensor

### FEATURES

- Choice of phototransistor or photodarlington output
- Accurate position sensing
- 0.070 in.(1.78 mm) slot width
- 18.0 in.(457 mm) min. 22 AWG UL 1007 wire leads

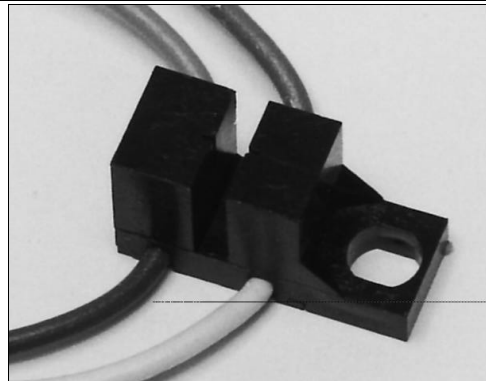

INFRA-7.TIF

### DESCRIPTION

The HOA1870 series consists of an infrared emitting diode facing an NPN silicon phototransistor (HOA1870-031) or photodarlington (HOA1870-033) encased in a black thermoplastic housing. Detector switching takes place whenever an opaque object passes through the slot between emitter and detector. A minimum of 18.0 in.(457 mm) lead wires provides alternate electrical connection when PC board mounting is not possible. This device is ideal for use in applications in which maximum position resolution is desired. Both emitter and detector have a 0.006 in.(0.152 mm) x 0.040 in.(1.02 mm) vertical aperture. The HOA1870 series employs plastic molded components. For additional component information see SEP8506, SDP8406 and SDP8106.

Housing material is polycarbonate. Housings are soluble in chlorinated hydrocarbons and ketones. Recommended cleaning agents are methanol and isopropanol.

Wire color code and functions are:

- Orange - IRED Anode
- White - Detector Collector
- Green - IRED Cathode
- Blue - Detector Emitter

### OUTLINE DIMENSIONS in inches (mm)

Tolerance 3 plc decimals ±0.010(0.25)  
2 plc decimals ±0.020(0.51)

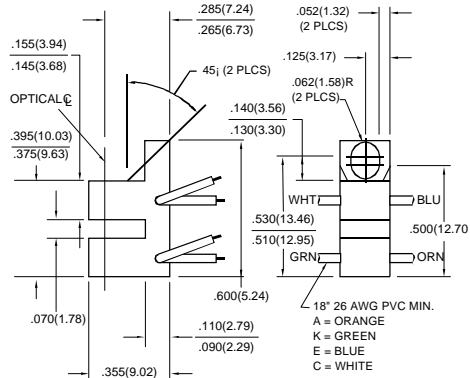

DIM\_043.d54

# HOA1870

## Transmissive Sensor

### ELECTRICAL CHARACTERISTICS (25°C unless otherwise noted)

| PARAMETER                            | SYMBOL        | MIN | TYP | MAX | UNITS         | TEST CONDITIONS   |
|--------------------------------------|---------------|-----|-----|-----|---------------|---|
| <b>IR EMITTER</b>                    |               |     |     |     |               |   |
| Forward Voltage                      | $V_F$         |     |     | 1.6 | V             | $I_F=20\text{ mA}$  |
| Reverse Leakage Current              | $I_R$         |     |     | 10  | $\mu\text{A}$ | $V_R=3\text{ V}$  |
| <b>DETECTOR</b>                      |               |     |     |     |               |   |
| Collector-Emitter Breakdown Voltage  | $V_{(BR)CEO}$ |     |     |     | V             | $I_C=100\ \mu\text{A}$  |
| HOA1870-031                          |               | 30  |     |     |               |   |
| HOA1870-033                          |               | 15  |     |     |               |   |
| Emitter-Collector Breakdown Voltage  | $V_{(BR)ECO}$ | 5.0 |     |     | V             | $I_E=100\ \mu\text{A}$  |
| Collector Dark Current               | $I_{CEO}$     |     |     |     | nA            | $V_{CE}=10\text{ V}$<br>$I_F=0$   |
| HOA1870-031                          |               |     |     | 100 |               |   |
| HOA1870-033                          |               |     |     | 250 |               |   |
| <b>COUPLED CHARACTERISTICS</b>       |               |     |     |     |               |   |
| On-State Collector Current           | $I_{C(ON)}$   |     |     |     | mA            | $V_{CE}=5\text{ V}$<br>$I_F=20\text{ mA}$                                       |
| HOA1870-031                          |               | 0.3 |     |     |               |   |
| HOA1870-033                          |               | 2.0 |     |     |               |   |
| Collector-Emitter Saturation Voltage | $V_{CE(SAT)}$ |     |     |     | V             | $I_F=20\text{ mA}$<br>$I_C=40\ \mu\text{A}$<br>$I_C=250\ \mu\text{A}$           |
| HOA1870-031                          |               |     |     | 0.4 |               |   |
| HOA1870-033                          |               |     |     | 1.1 |               |   |
| Rise And Fall Time                   | $t_r, t_f$    |     |     |     | $\mu\text{s}$ | $V_{CC}=5\text{ V}, I_C=1\text{ mA}$<br>$R_L=1000\ \Omega$<br>$R_L=100\ \Omega$ |
| HOA1870-031                          |               |     |     | 15  |               |   |
| HOA1870-033                          |               |     |     | 75  |               |   |

### ABSOLUTE MAXIMUM RATINGS

(25°C Free-Air Temperature unless otherwise noted)

Operating Temperature Range -40°C to 85°C

Storage Temperature Range -40°C to 85°C

Soldering Temperature (5 sec) 240°C

#### IR EMITTER

Power Dissipation 100 mW <sup>(1)</sup>

Reverse Voltage 3 V

Continuous Forward Current 50 mA

#### DETECTOR

Collector-Emitter Voltage 30 V TRANS. 15 V DARLINGTON

Emitter-Collector Voltage 5 V 5 V

Power Dissipation 100 mW <sup>(1)</sup> 100 mW <sup>(1)</sup>

Collector DC Current 30 mA 30 mA

### SCHEMATIC

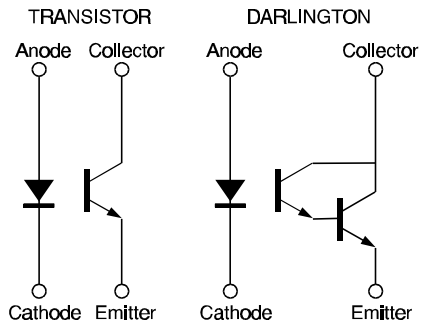

Honeywell reserves the right to make changes in order to improve design and supply the best products possible.

# Honeywell

# HOA1870

## Transmissive Sensor

Fig. 1 IRED Forward Bias Characteristics

gra\_092.ds4

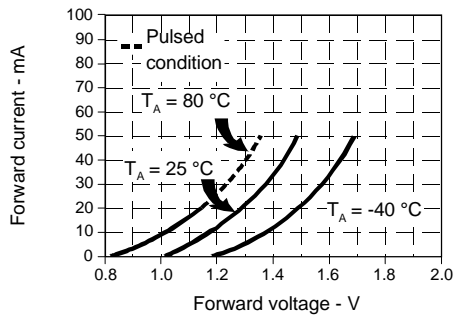

Fig. 2 Non-Saturated Switching Time vs Load Resistance

gra\_096.ds4

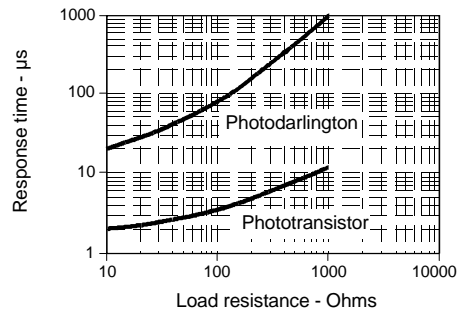

Fig. 3 Dark Current vs Temperature

gra\_301.cdr

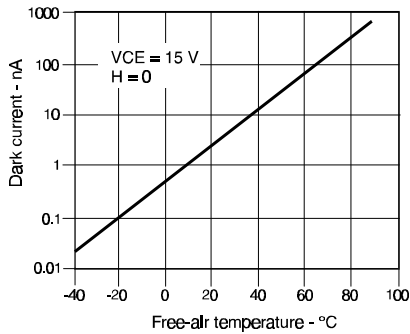
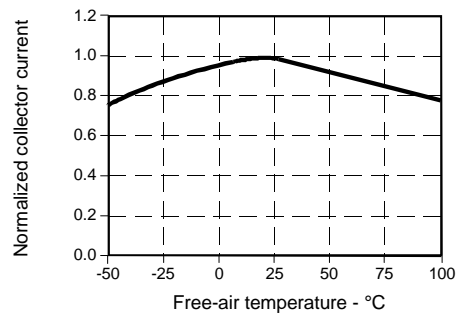

Fig. 4 Collector Current vs Ambient Temperature

gra\_095.ds4



All Performance Curves Show Typical Values

**HOA1870**  
Transmissive Sensor

---

Honeywell reserves the right to make changes in order to improve design and supply the best products possible.

**Honeywell**

285