

Document	Datasheet
Type	RC Type Filter
Application	EMI/ESD Filter
Part No.	AVRC series
Revision	0

DATASHEET

Applications

- Possible to apply variously for elimination of high frequency noise, and protection of ESD.
- Intercept noise generating from control line and data line of LCD & Camera module.
- Interrupt ESD flowing into the LCD and camera module.

Features

- R-C type 4 channels array filter
- 0603 size
- IEC 61000-4-2 (ESD) Level #4, MSL Level #1
- Multilayer laminated structure



Notes

The contents of this datasheet are subject to change without notice. Please confirm the specifications and delivery conditions when placing your order.

AVRC 0603 series

Amotech Multilayer Chip EMI and ESD filter



Overview

This product is a multi-functioned filter for EMI/ESD protection with C-R-C structure of type Π (π), and mainly uses it to interrupt EMI noise at the end of camera and LCD, and uses to protect ESD of high voltage. Especially, it shows its excellent reduction characteristics at the 800 ~ 3,000GHz band in the receiving base band of terminal.

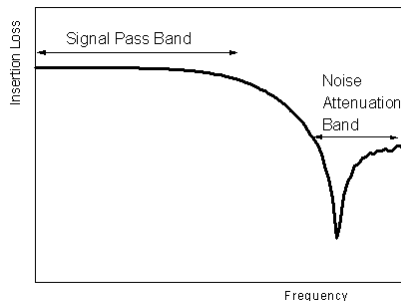

Fig 1 General characteristics of EMI & ESD filter

Features

- R-C type 4 channels array filter
- 0603 size
- IEC 61000-4-2 (ESD) Level #4, MSL Level #1
- Multilayer laminated structure

Applications

- Possible to apply variously for elimination of high frequency noise, and protection of ESD.
- Intercept noise generating from control line and data line of LCD & Camera module.
- Interrupt ESD flowing into the LCD and camera module.

Model Description

AVRC	5	S	03	Q	050	100R
(1)	(2)	(3)	(4)	(5)	(6)	(7)

- (1) Series name : "AVRC" - R-C Type EMI & ESD filter
- (2) Maximum continuous working voltage (Vdc) : "5" - 5.5V, "14" - 14V, "18" - 18V
- (3) Varistor voltage tolerance : "S" - special order
- (4) Chip Size : "03" - 0603 (1.6 x 0.8 mm)
- (5) Configuration : "Q" - Quad array (4 elements)
- (6) Capacitance : "050" - C1+C2 = 50 pF,
- (7) Typical Resistance : "100R" - 100 \pm 30 Ω

AVRC 0603 series

Amotech Multilayer Chip EMI and ESD filter



Electrical characteristics

Part No.	Vdc ⁽¹⁾	Varistor voltage (Vn) @1mA DC	Rdc R series between I/O ⁽²⁾	Rdc tolerance	Cp (@ 1MHz, V _{rms} =0.5V) C1+C2	Cp tolerance	IR (@3V DC)	Cut-off Frequency (-3dB)	Minimum -20dB ATT. Band
	(V)	(V)	(Ω)	(%)	(pF)		(MΩ)	(MHz)	(MHz)
AVRC 5S 03Q 050 050R	5.5	14±4	50	±30	25+25	±30 %	> 10	70	600~3000
AVRC 5S 03Q 050 100R	5.5	14±4	100	±30	25+25	±30 %	> 10	70	450~3000
AVRC 5S 03Q 050 200R	5.5	14±4	200	±30	25+25	±30 %	> 10	70	350~3000
AVRC 5S 03Q 050 400R	5.5	14±4	400	±30	25+25	±30 %	> 10	70	300~3000
AVRC 14S 03Q 030 050R	14	23±5	50	±30	15+15	±30 %	> 10	100	800~3000
AVRC 14S 03Q 030 100R	14	23±5	100	±30	15+15	±30 %	> 10	100	700~3000
AVRC 14S 03Q 030 200R	14	23±5	200	±30	15+15	±30 %	> 10	120	650~3000
AVRC 14S 03Q 030 400R	14	23±5	400	±30	15+15	±30 %	> 10	120	600~3000
AVRC 18S 03Q 015 010R	18	30±6	10	±30	7.5+7.5	±30 %	> 10	350	1700~3000
AVRC 18S 03Q 015 050R	18	30±6	50	±30	7.5+7.5	±30 %	> 10	350	1500~3000
AVRC 18S 03Q 015 100R	18	30±6	100	±30	7.5+7.5	±30 %	> 10	350	1100~3000
AVRC 18S 03Q 007 010R	18	40±8	10	±30	3.5+3.5	3~7pF	> 10	850	3500~5000
AVRC 18S 03Q 007 050R	18	40±8	50	±30	3.5+3.5	3~7pF	> 10	850	3100~5000

- (1) Maximum continuous DC working voltage
 (2) Series resistance between input and output

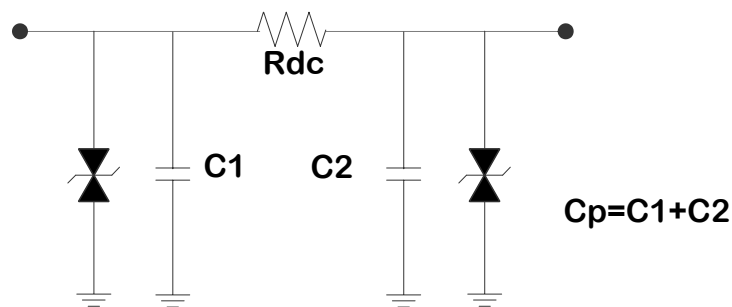

Fig.2 Equivalent Circuit

AVRC 0603 series

Amotech Multilayer Chip EMI and ESD filter



Appearance

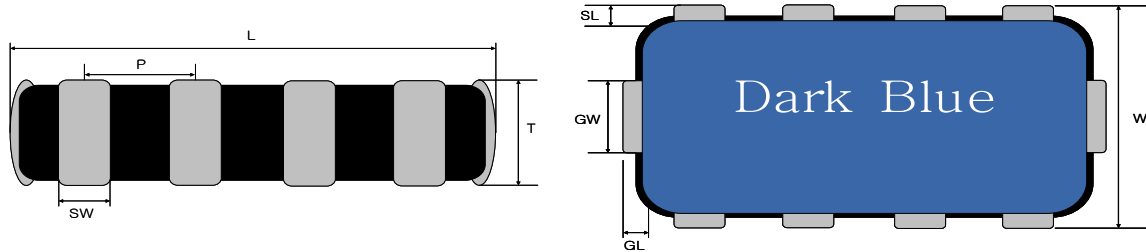

(Unit : mm)

	L	W	T	GL	GW	SL	SW	P
Size	1.60±0.10	0.80±0.10	0.44±0.05	0.15±0.05	0.20±0.05	0.15±0.05	0.20±0.05	0.40±0.05

Recommended Land pattern (Typical Dimensions)

- Land pattern

- Mask (Stencil) pattern

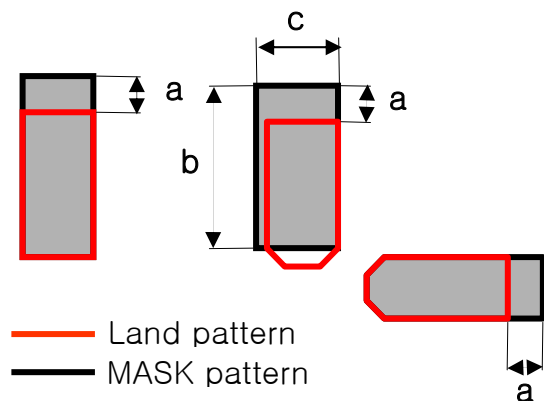
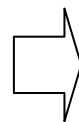
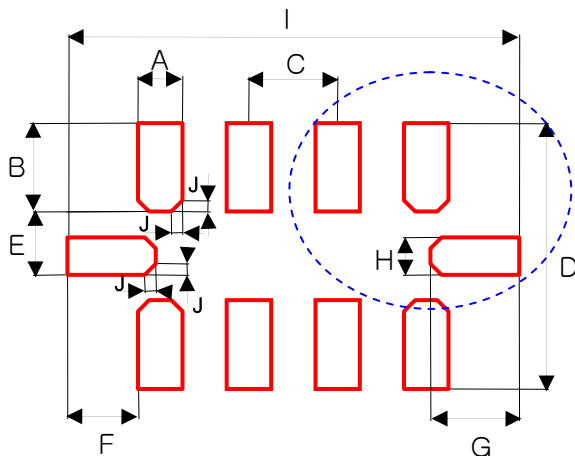

ITEM	A	B	C	D	E	F	G	H	I	J
Size (mm)	0.2	0.4	0.4	1.2	0.285	0.32	0.4	0.17	2.04	0.05

ITEM	a	b	c
Size (mm)	0.1	0.45	0.23

www.DataSheet4U.com

AVRC 0603 series

Amotech Multilayer Chip EMI and ESD filter



Recommended Soldering Profile

- Pb Free Solder Paste : Sn/Ag/ Cu (96.5 / 3.0 / 0.5)

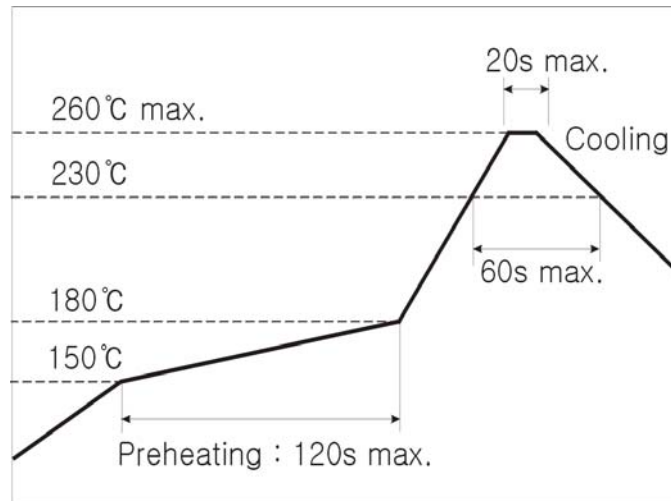

AVRC 0603 series

Amotech Multilayer Chip EMI and ESD filter



EMI Characteristics (Typical data)

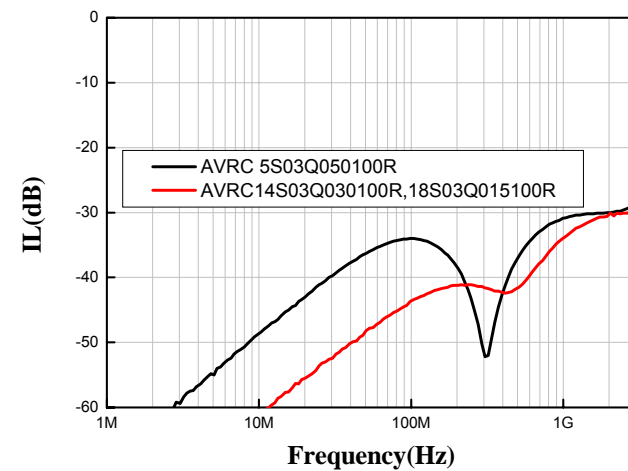
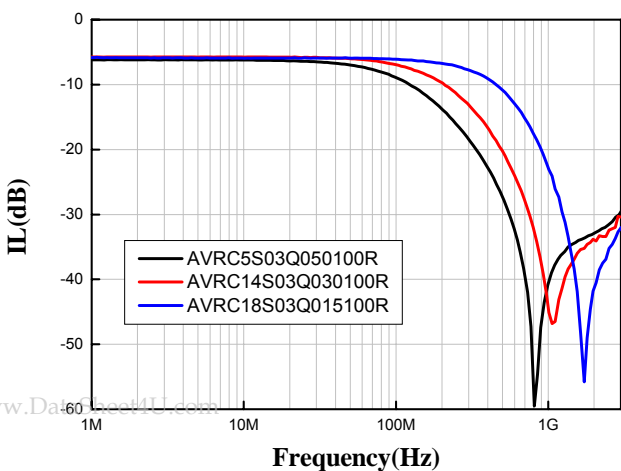
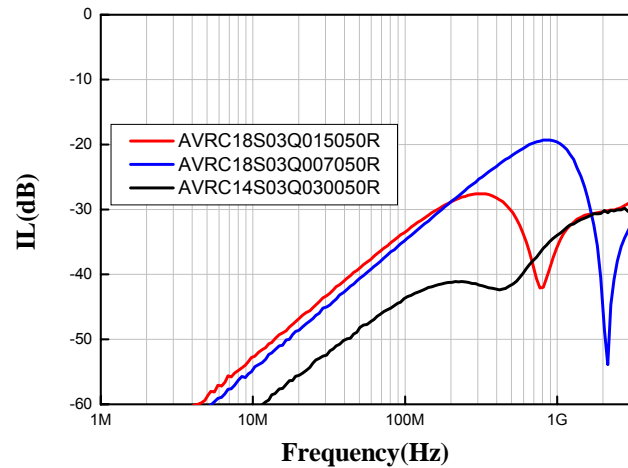
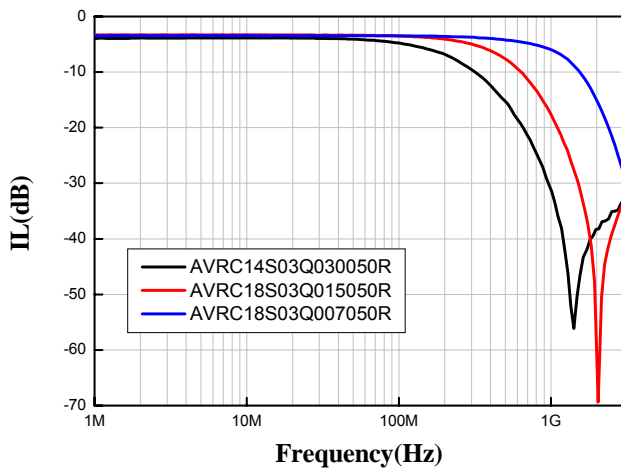
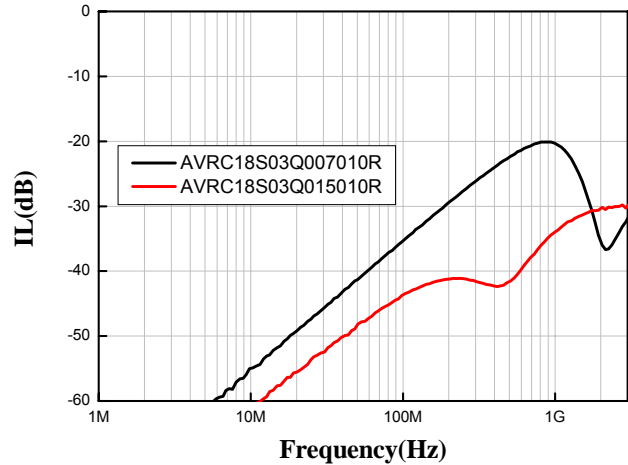
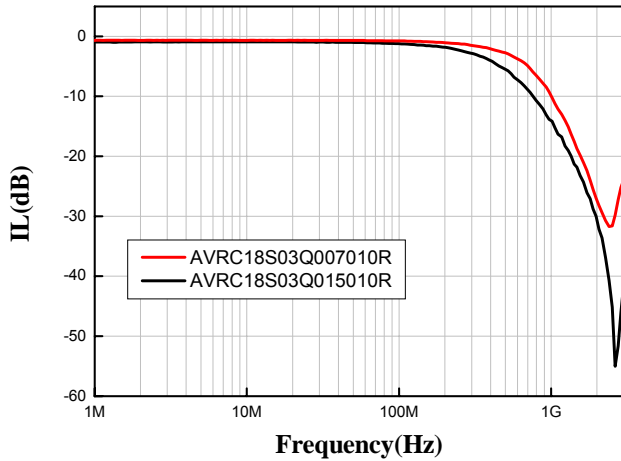

www.DataSheet4U.com

AVRC 0603 series

Amotech Multilayer Chip EMI and ESD filter

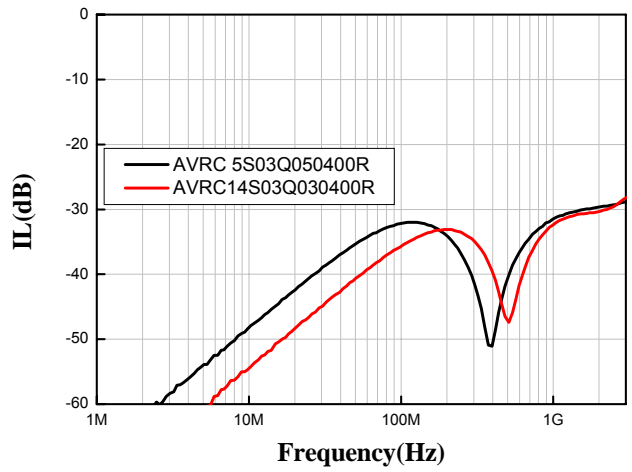
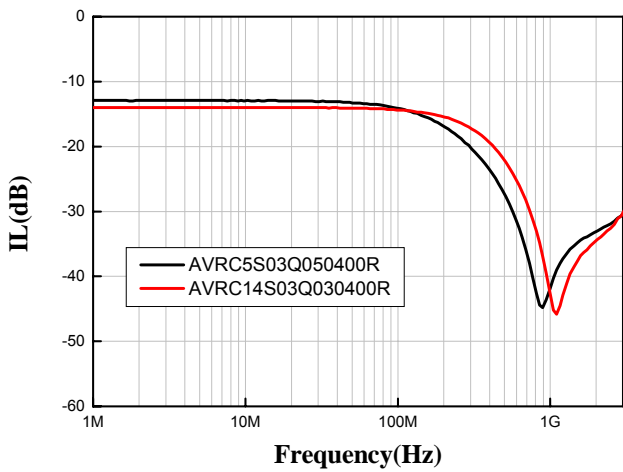
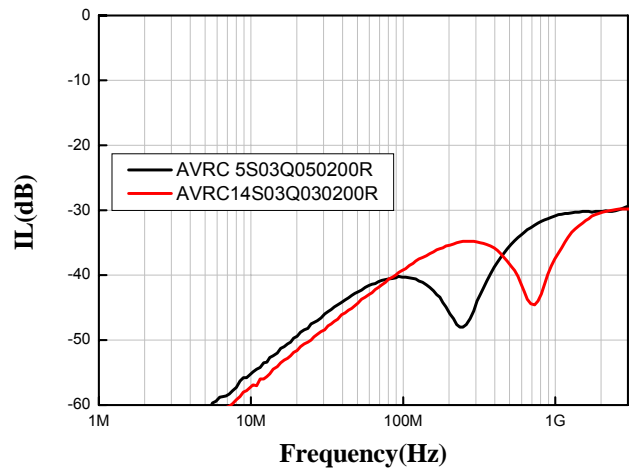
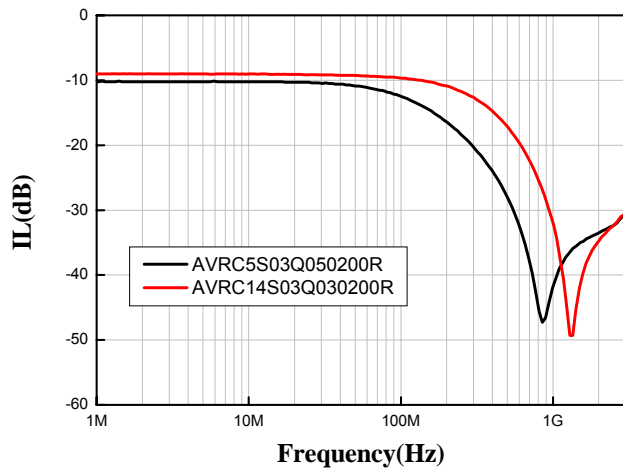

AVRC 0805 series

Amotech Multilayer Chip EMI and ESD filter



Overview

This product is a multi-functioned filter for EMI/ESD protection with C-R-C structure of type Π (π), and mainly uses it to interrupt EMI noise at the end of camera and LCD, and uses to protect ESD of high voltage. Especially, it shows its excellent reduction characteristics at the 800 ~ 3,000GHz band in the receiving base band of terminal.

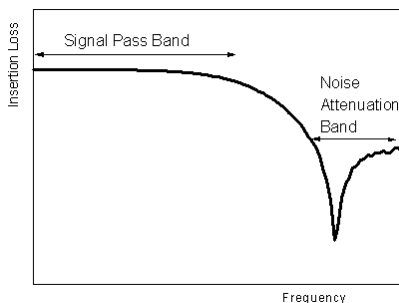

Fig 1 General characteristics of EMI & ESD filter

Features

- R-C type 4 channels array filter
- 0508 size
- IEC 61000-4-2 (ESD) Level #4, MSL Level #1
- Multilayer laminated structure

Applications

- Possible to apply variously for elimination of high frequency noise, and protection of ESD.
- Intercept noise generating from control line and data line of LCD & Camera module.
- Interrupt ESD flowing into the LCD and camera module.

Model Description

AVRC	5	S	05	Q	050	100R
(1)	(2)	(3)	(4)	(5)	(6)	(7)

- (1) Series name : "AVRC" - R-C Type EMI & ESD filter
- (2) Maximum continuous working voltage (Vdc) : "5" - 5V, "14" - 14V, "18" - 18V
- (3) Varistor voltage tolerance : "S" - special order
- (4) Chip Size : "05" - 0508 (1.2 x 2.0 mm)
- (5) Configuration : "Q" - Quad array (4 elements), "D" - Dual array (2 elements)
- (6) Capacitance : "050" - C1+C2 = 50 pF, "030" - C1+C2 = 30pF
Typical Resistance : "010R" - 10 ± 3 Ω, "050R" - 50 ± 15 Ω,
- (7) "100R" - 100 ± 30 Ω, "200R" - 200 ± 60 Ω,
"400R" - 400 ± 120 Ω

AVRC 0805 series

Amotech Multilayer Chip EMI and ESD filter



Electrical characteristics

Part No.	Vdc ⁽¹⁾	Varistor voltage (Vn) @1mA DC	Rdc R series between I/O ⁽²⁾	Rdc tolerance	Cp (@ 1MHz, V _{rms} =0.5V) C1+C2	Cp tolerance	IR (@3V DC)	Insertion Loss (@1MHz)	Cut-off Frequency (-3dB)	Minimum -20dB ATT. Band
	(V)	(V)	(Ω)	(%)	(pF)		(MΩ)	(dB)	(MHz)	(MHz)
AVRC 5S 05Q 050 050R	5.5	14±4	50	±30	25+25	±30 (%)	> 10	-4.3~-2.6	80	400~3000
AVRC 5S 05Q 050 100R	5.5	14±4	100	±30	25+25	±30 (%)	> 10	-7.2~-4.6	80	400~3000
AVRC 5S 05Q 100 050R	5.5	14±4	50	±30	50+50	±30	> 10	-4.3~-2.6	40	250~3000
AVRC 5S 05Q 100 100R	5.5	14±4	100	±30	50+50	±30 (%)	> 10	-7.2~-4.6	40	200~3000
AVRC 14S 05Q 030 050R	14	23±5	50	±30	15 +15	±30(%)	> 10	-4.3~-2.6	150	750~3000
AVRC 14S 05Q 030 100R	14	23±5	100	±30	15+15	±30 (%)	> 10	-7.2~-4.6	150	700~3000
AVRC 18S 05Q 007 050R	18	60 ~150	50	±30	3.5+3.5	3 ~ 7 (pF)	> 10	-4.3~-2.6	1000	3500~5000
AVRC 18S 05Q 007 100R	18	105±45	100	±30	3.5+3.5	3 ~ 7 (pF)	> 10	-7.2~-4.6	1000	2800~5000
AVRC 18S 05Q 015 010R	18	30±6	10	±30	7.5+7.5	±30 (%)	> 10	-1.0~-0.5	700.	1900~5000
AVRC 18S 05Q 015 050R	18	30±6	50	±30	7.5+7.5	±30 (%)	> 10	-4.3~-2.6	450	1500~3000
AVRC 18S 05Q 015 100R	18	30±6	100	±30	7.5+7.5	±30 (%)	> 10	-7.2~-4.6	400	1100~3000
AVRC 18S 05Q 030 050R	18	30±6	50	±30	15+15	±30(%)	> 10	-4.3~-2.6	150 max	750~3000

(1) Maximum continuous DC working voltage

(2) Series resistance between input and output

Equivalent Circuit

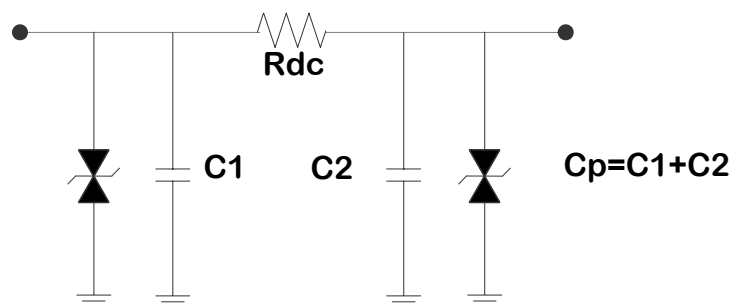

Fig.2 Equivalent Circuit

AVRC 0805 series

Amotech Multilayer Chip EMI and ESD filter



Appearance

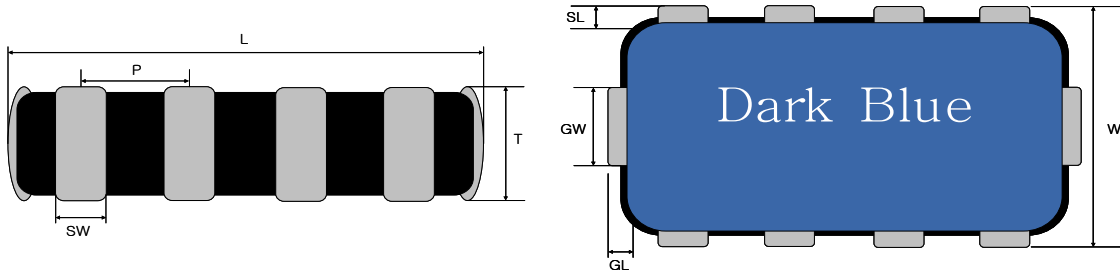

(Unit : mm)

	L	W	T	GL	GW	SL	SW	P
Size	2.05±0.10	1.25±0.10	0.55±0.10	0.25±0.10	0.30±0.10	0.25±0.10	0.25±0.10	0.50±0.10

Recommended Land pattern (Typical Dimensions)

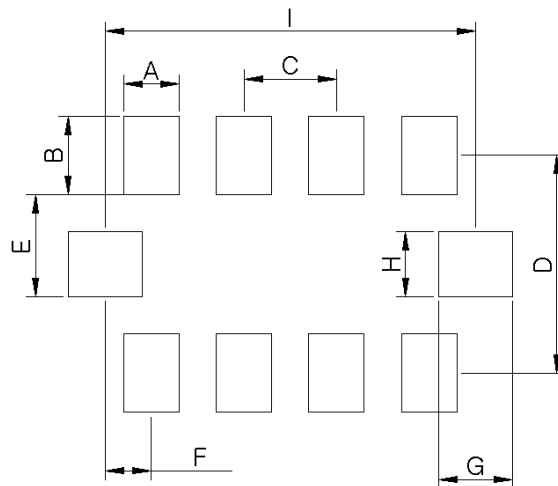

(Unit : mm)

A	B	C	D	E	F	G	H	I
0.3	0.42	0.5	1.17	0.55	0.25	0.4	0.35	2

AVRC 0805 series

Amotech Multilayer Chip EMI and ESD filter



Recommended Soldering Profile

- Pb Free Solder Paste : Sn/Ag/ Cu (96.5 / 3.0 / 0.5)

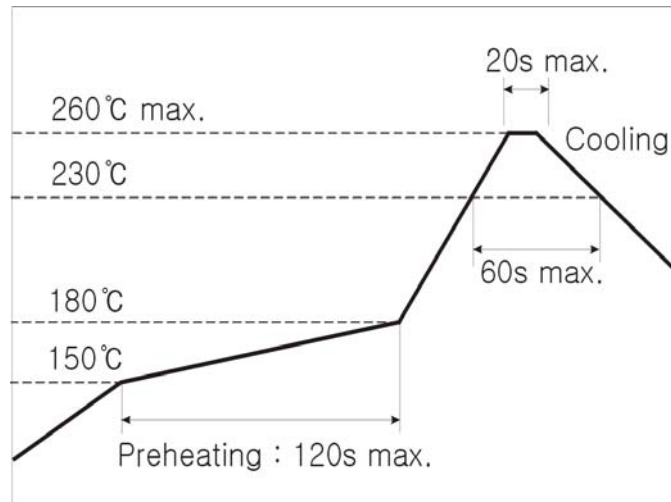

AVRC 0805 series

Amotech Multilayer Chip EMI and ESD filter



EMI Characteristics (Typical data)

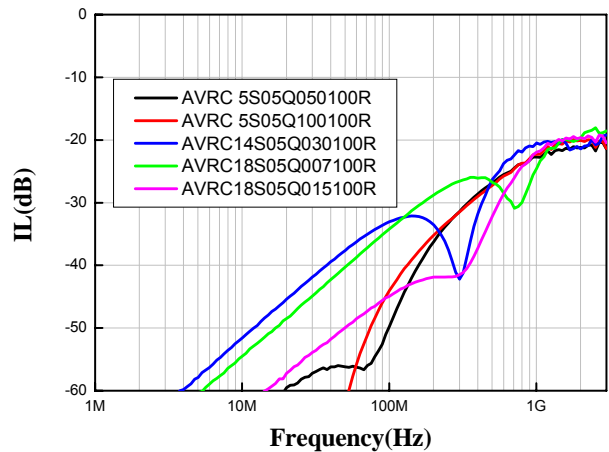
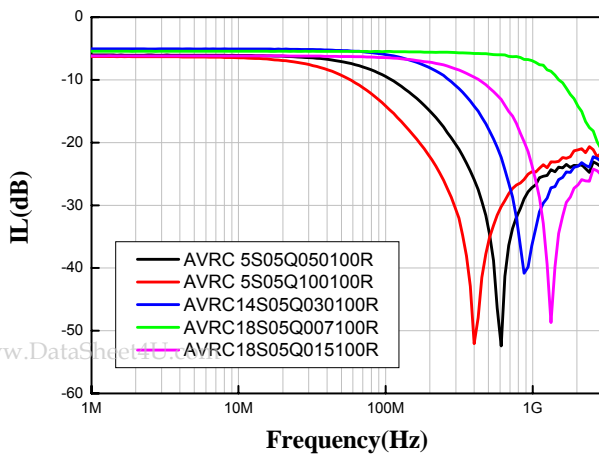
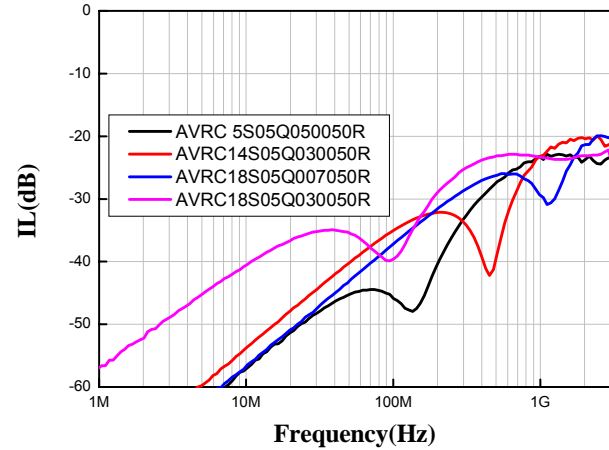
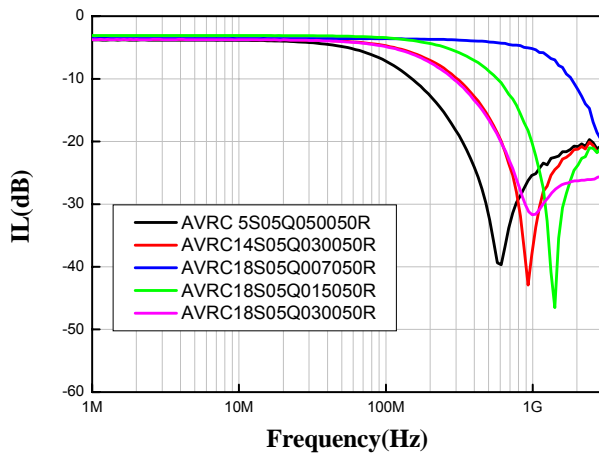
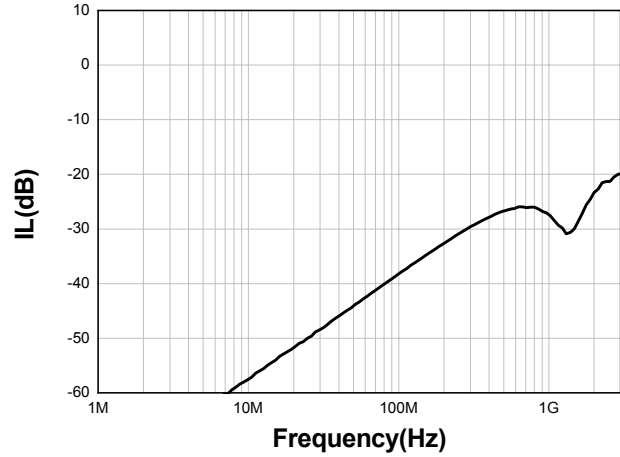
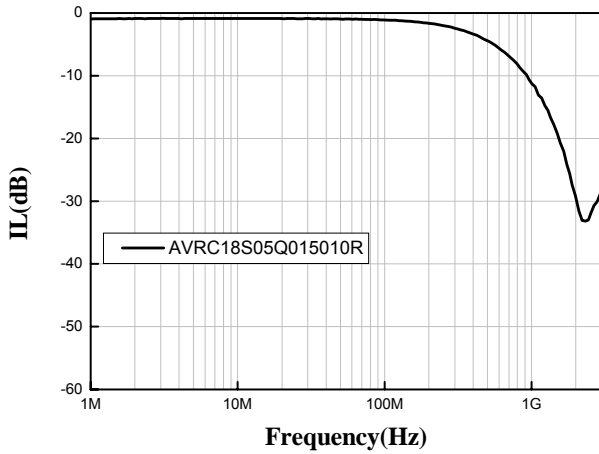

AVRC 0504 series for Speaker

Amotech Multilayer Chip EMI and ESD filter



Overview

This product is a multi-functioned filter for EMI/ESD protection with C-R-C structure of type Π (π), and mainly uses it to interrupt EMI noise at the end of camera and LCD, and uses to protect ESD of high voltage. Especially, it shows its excellent reduction characteristics band in the receiving base band of terminal.

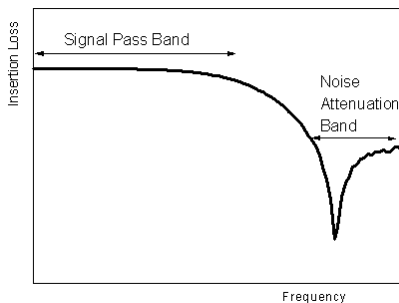

Fig 1 General characteristics of EMI & ESD filter

Features

- Lead free
- R-C type 2 channels array filter
- 0504 size
- IEC 61000-4-2 (ESD) Level #4,
- Multilayer laminated structure

Applications

- Possible to apply variously for elimination of high frequency noise, and protection of ESD.
- Intercept noise generating from control line and data line of PHF MIC & Speaker part.
- Interrupt ESD flowing into the PHF MIC & Speaker part.

Model Description

AVRC	5	S	04	D	200	010R
(1)	(2)	(3)	(4)	(5)	(6)	(7)

- (1) Series name : "AVRC" - R-C Type EMI & ESD filter
- (2) Maximum continuous working voltage (Vdc) : "5"- 5.5 V, "14"- 14V, "18"-18V
- (3) Varistor voltage tolerance : "S" - special order
- (4) Chip Size : "04" – 0504 (1.4 x 0.9 mm)
- (5) Configuration : "D"-Dual array (2 elements)
- (6) Capacitance : "200" - C1+C2 = 200 pF
- (7) Typical Resistance : "010R" - $10 \pm 3 \Omega$., "100R" – $100 \pm 30 \Omega$

AVRC 0504 series for Speaker

Amotech Multilayer Chip EMI and ESD filter



Electrical characteristics

Part No.	Vdc ⁽¹⁾	Varistor voltage (Vn) @1mA DC	Rdc Rseries between I/O ⁽²⁾	Rdc tolerance	Cp (@ 1MHz, V _{rms} =0.5V) C1+C2	Cp tolerance	IR (@3V DC)	IL Leakage current @Vdc	Cut-off Frequency (-3dB)	Minimum -20dB ATT. Band
	(V)	(V)	(Ω)	(%)	(pF)	(%)	(MΩ)	(uA)	(MHz)	(MHz)
AVRC 5S 04D 200 010R	5.5	14±4	10	±30	100+100	±30	>10	20max	20	400~2500
AVRC 5S 04D 350 010R	5.5	14±4	10	±30	175+175	±30	> 10	20max	10	300~2500
AVRC 14S 04D 030 010R	14	23±5	10	±30	15+15	±30	>10	20max	200	1000~2500

- (1) Maximum continuous DC working voltage
- (2) Series resistance between input and output

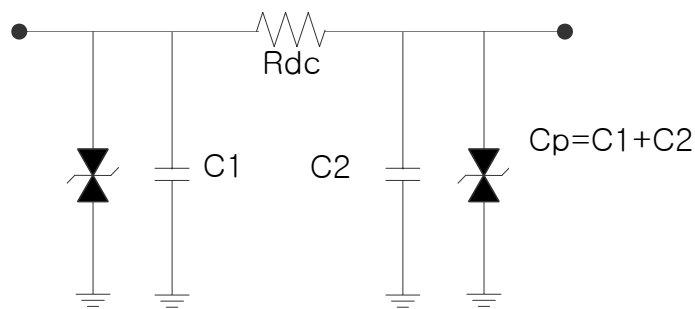
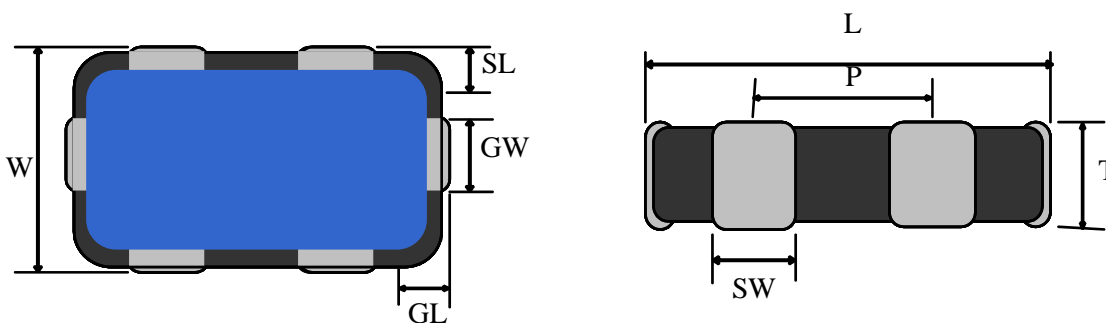

Fig.2 Equivalent Circuit

Appearance



www.DataSheet4U.com

Symbol	L	W	T	GL	GW	SL	SW	P
Dimension (mm)	1.40±0.10	0.90±0.10	0.55±0.15	0.25±0.10	0.30±0.05	0.25±0.10	0.30±0.05	0.64±0.05

AVRC 0504 series for Speaker

Amotech Multilayer Chip EMI and ESD filter



Recommended Land pattern (Typical Dimensions)

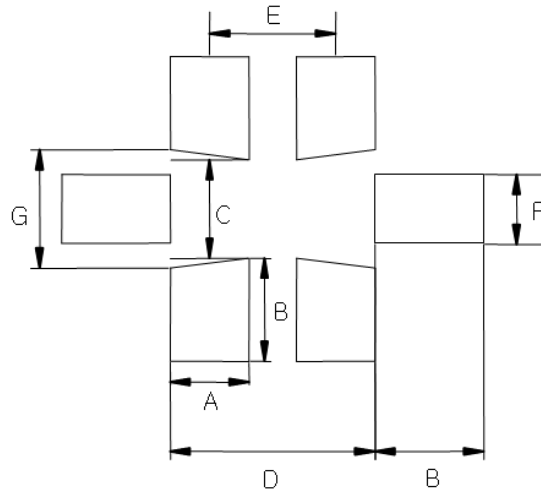

(Unit : mm)

A	B	C	D	E	F	G
0.35	0.5	0.5	1.04	0.64	0.35	0.65

Recommended Soldering Profile

- Pb Free Solder Paste : Sn/Ag/Cu (96.5 / 3.0 / 0.5)

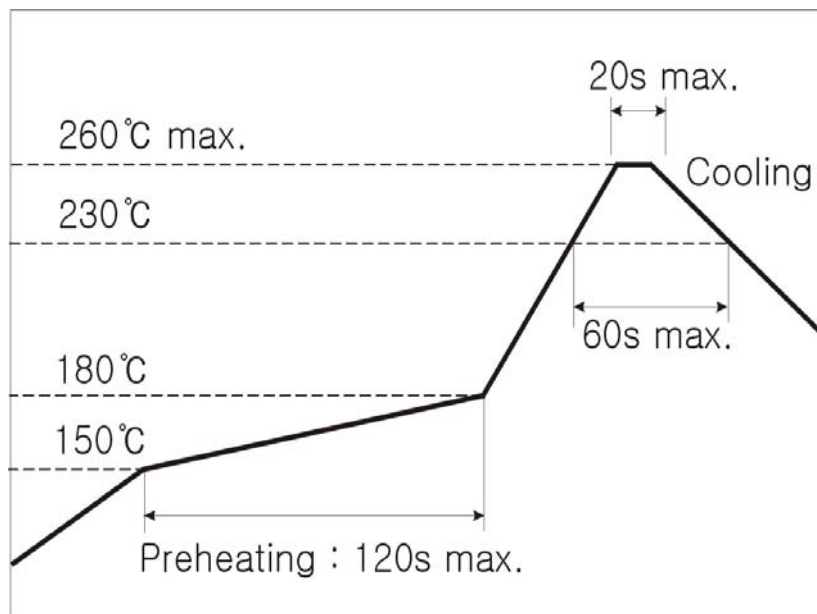

www.DataSheet4U.com

AVRC 0504 series for Speaker

Amotech Multilayer Chip EMI and ESD filter



EMI Characteristics (Typical data)

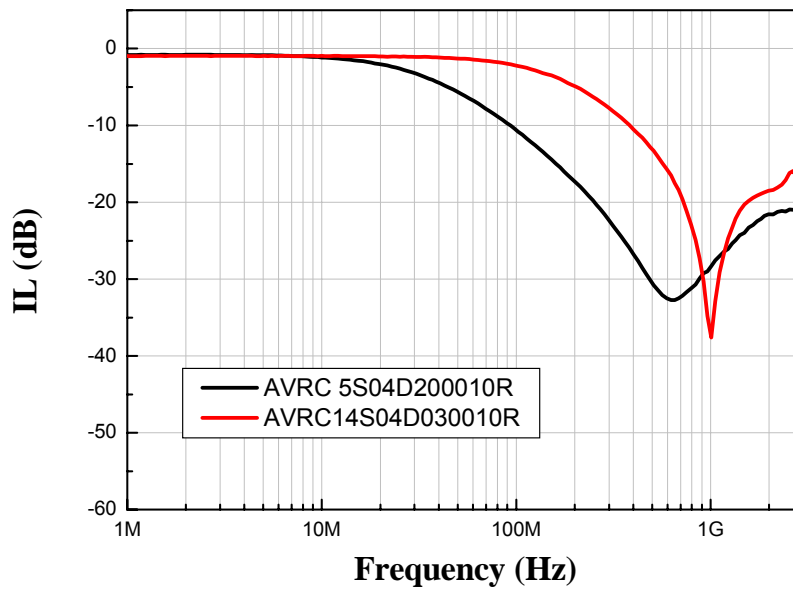
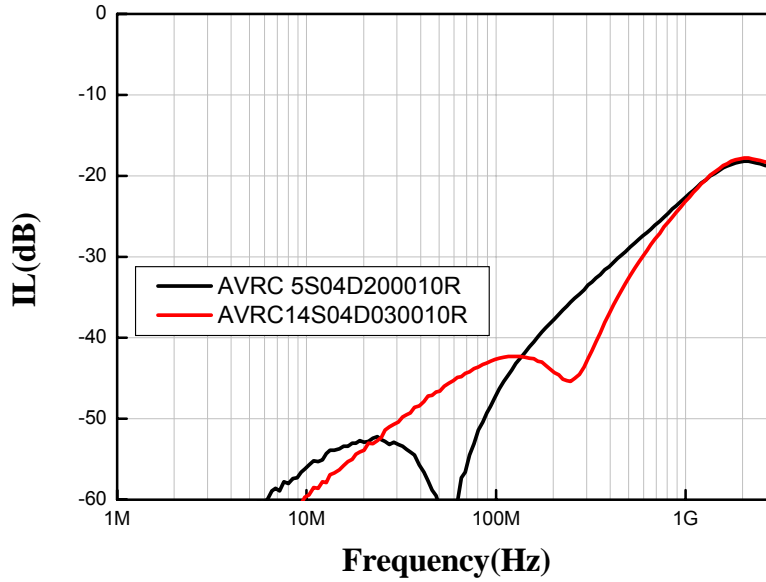

AVRC 0504 series for Speaker

Amotech Multilayer Chip EMI and ESD filter



ESD absorption characteristics (voltage waveform)

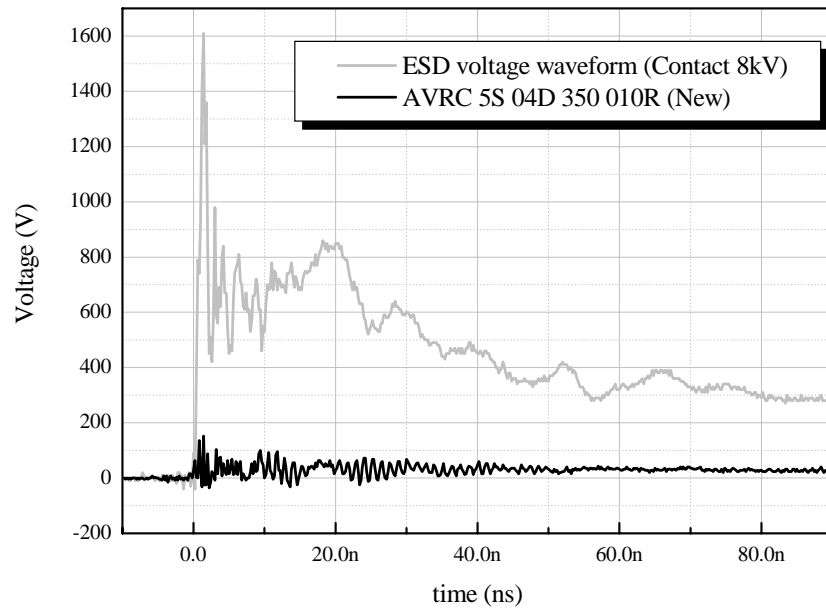
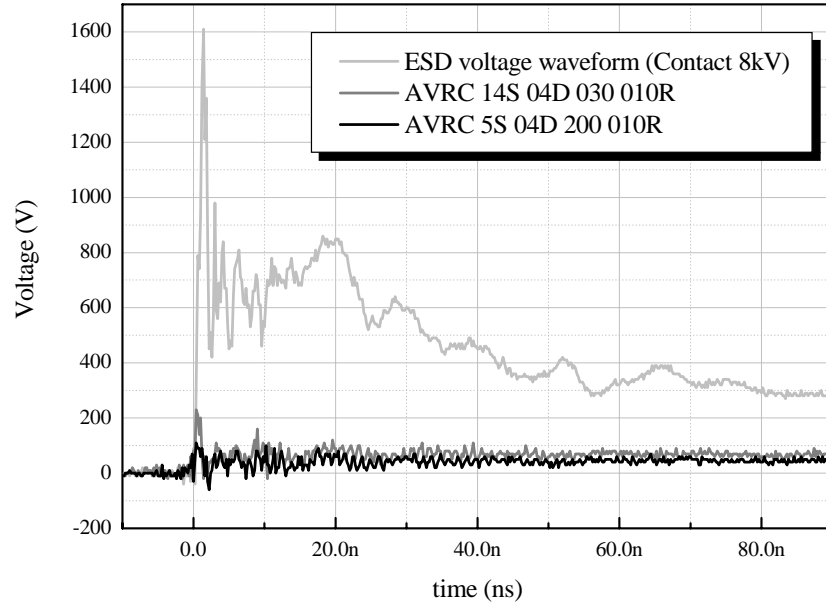

AVRC 0504 series for MIC

Amotech Multilayer Chip EMI and ESD filter



Overview

This product is a multi-functioned filter for EMI/ESD protection with C-R-C structure of type Π (pi), and mainly uses it to interrupt EMI noise at the end of camera and LCD, and uses to protect ESD of high voltage. Especially, it shows its excellent reduction characteristics band in the receiving base band of terminal.

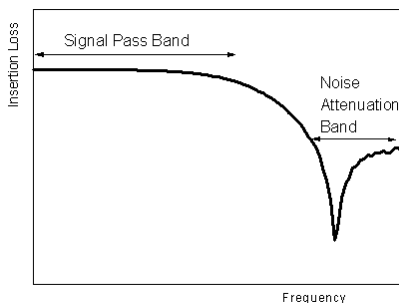

Fig 1 General characteristics of EMI & ESD filter

Features

- Lead free
- R-C type 2 channels array filter
- 0504 size
- IEC 61000-4-2 (ESD) Level #4,
- Multilayer laminated structure

Applications

- Possible to apply variously for elimination of high frequency noise, and protection of ESD.
- Intercept noise generating from control line and data line of PHF MIC & Speaker part.
- Interrupt ESD flowing into the PHF MIC & Speaker part.

Model Description

AVRC	5	S	04	D	200	100R
(1)	(2)	(3)	(4)	(5)	(6)	(7)

- (1) Series name : "AVRC" - R-C Type EMI & ESD filter
- (2) Maximum continuous working voltage (Vdc) : "5"- 5.5 V, "14"- 14V, "18"-18V
- (3) Varistor voltage tolerance : "S" - special order
- (4) Chip Size : "04" – 0504 (1.4 x 0.9 mm)
- (5) Configuration : "D"-Dual array (2 elements)
- (6) Capacitance : "200" - C1+C2 = 200 pF
- (7) Typical Resistance : "010R" - 10 ± 3 Ω., "100R" – 100 ± 30 Ω

AVRC 0504 series for MIC

Amotech Multilayer Chip EMI and ESD filter



Electrical characteristics

Part No.	Vdc ⁽¹⁾	Varistor voltage (Vn) @1mA DC	Rdc Rseries between I/O ⁽²⁾	Rdc tolerance	Cp (@ 1MHz, V _{rms} =0.5V) C1+C2	Cp tolerance	IR (@3V DC)	IL Leakage current @Vdc	Cut-off Frequency (-3dB)	Minimum -20dB ATT. Band
	(V)	(V)	(Ω)	(%)	(pF)	(%)	(MΩ)	(uA)	(MHz)	(MHz)
AVRC 5S 04D 050 100R	5.5	14±4	100	±30	25+25	±30	>10	20max	100	500~2500
AVRC 5S 04D 200 100R	5.5	14±4	100	±30	100+100	±30	>10	20max	20	200~2500
AVRC 5S 04D 350 100R	5.5	14±4	100	±30	350	±30	> 10	20max	10	100~2500

- (1) Maximum continuous DC working voltage
- (2) Series resistance between input and output

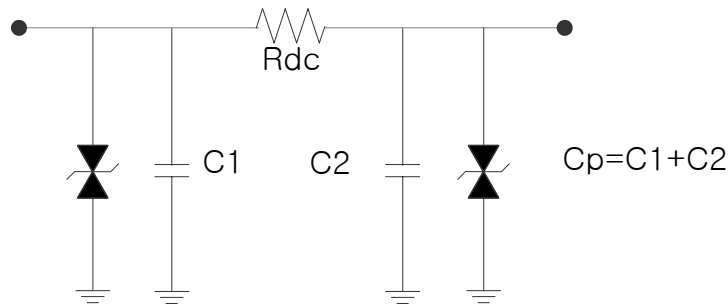
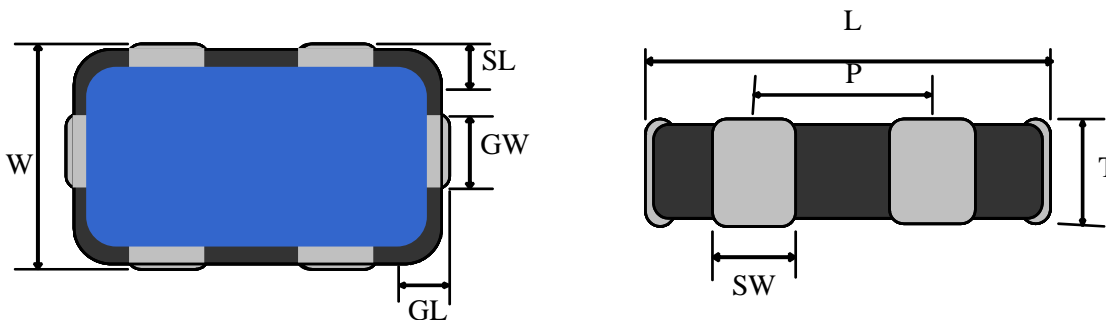

Fig.2 Equivalent Circuit

Appearance



Symbol	L	W	T	GL	GW	SL	SW	P
Dimension (mm)	1.40±0.10	0.90±0.10	0.55±0.15	0.25±0.10	0.30±0.05	0.25±0.10	0.30±0.05	0.64±0.05

AVRC 0504 series for MIC

Amotech Multilayer Chip EMI and ESD filter



Recommended Land pattern (Typical Dimensions)

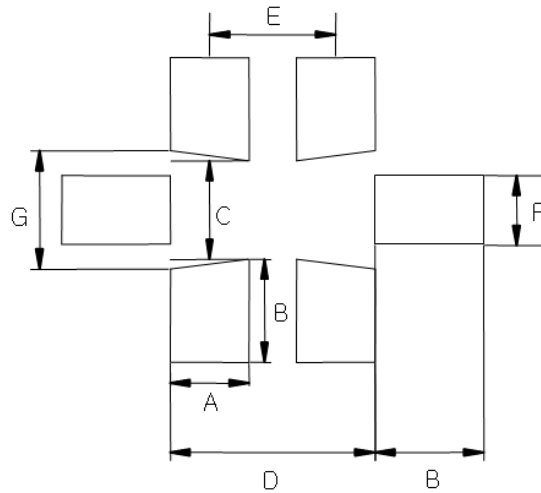

(Unit : mm)

A	B	C	D	E	F	G
0.35	0.5	0.5	1.04	0.64	0.35	0.65

Recommended Soldering Profile

- Pb Free Solder Paste : Sn/Ag/Cu (96.5 / 3.0 / 0.5)

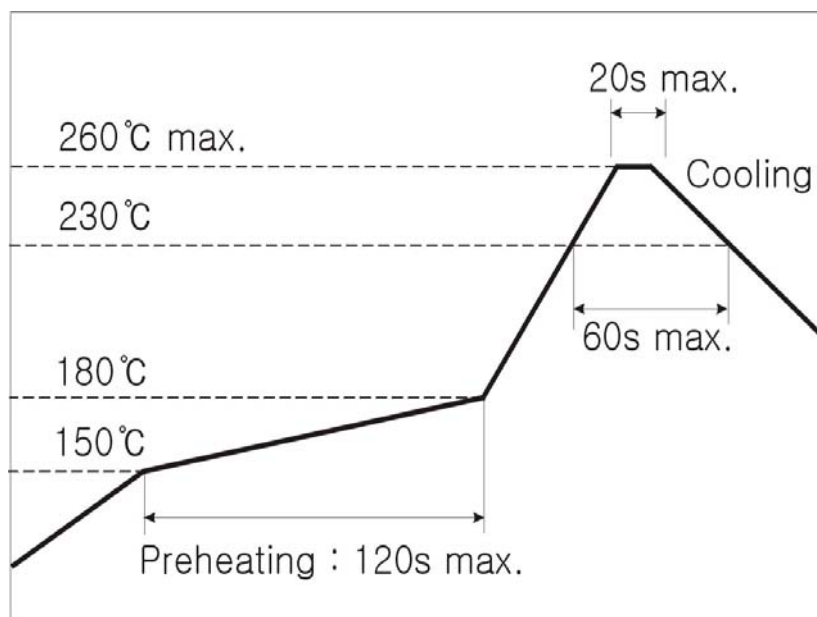

www.DataSheet4U.com

AVRC 0504 series for MIC

Amotech Multilayer Chip EMI and ESD filter



EMI Characteristics (Typical data)

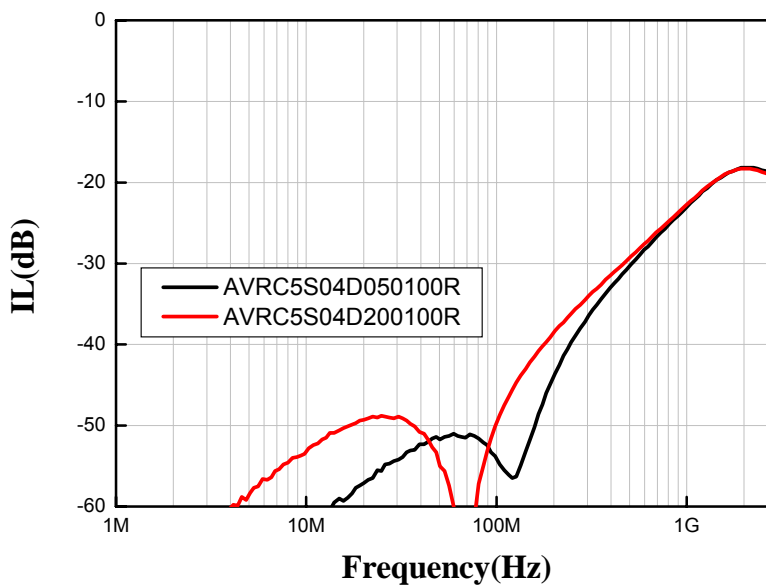
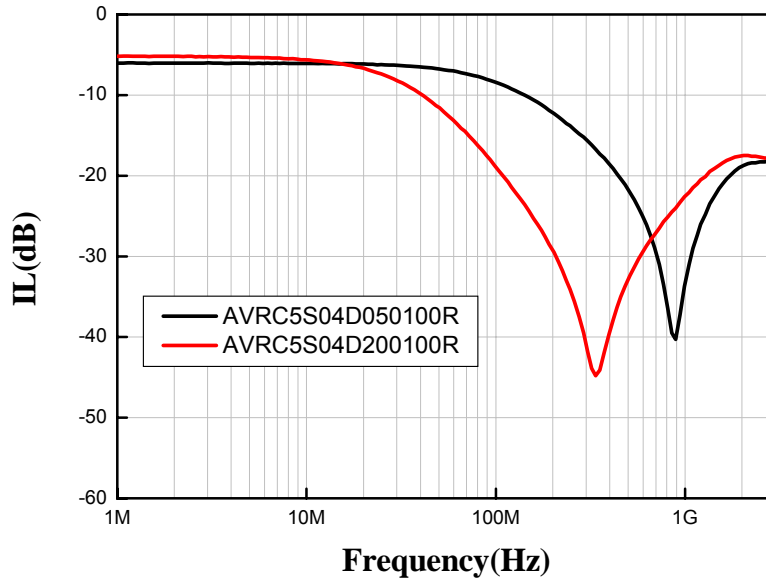

AVRC 0504 series for MIC

Amotech Multilayer Chip EMI and ESD filter



ESD absorption characteristics (voltage waveform)

