

FS30KMH-03

HIGH-SPEED SWITCHING USE

FS30KMH-03



- 2.5V DRIVE
- V_{DSS} 30V
- $r_{DS(ON)}$ (MAX) $46m\Omega$
- I_D 30A
- V_{iso} 2000V
- Integrated Fast Recovery Diode (TYP.) 45ns

OUTLINE DRAWING

Dimensions in mm

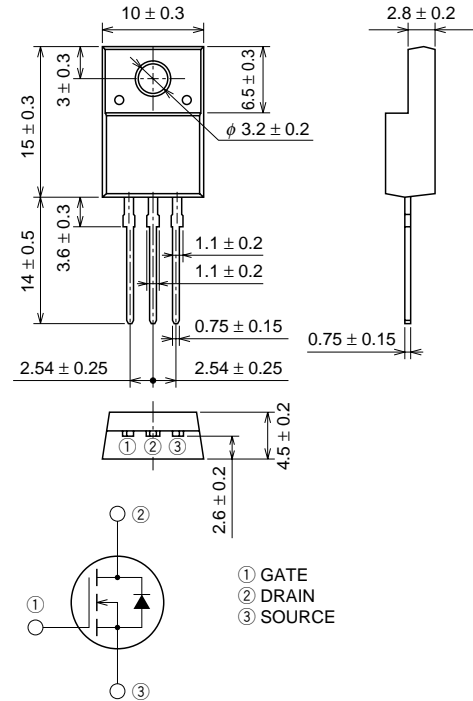

TO-220FN

APPLICATION

Motor control, Lamp control, Solenoid control
DC-DC converter, etc.

MAXIMUM RATINGS (Tc = 25°C)

Symbol	Parameter	Conditions	Ratings	Unit
V_{DSS}	Drain-source voltage	$V_{GS} = 0V$	30	V
V_{GSS}	Gate-source voltage	$V_{DS} = 0V$	± 10	V
I_D	Drain current		30	A
I_{DM}	Drain current (Pulsed)		120	A
I_{DA}	Avalanche drain current (Pulsed)	$L = 30\mu H$	30	A
I_S	Source current		30	A
I_{SM}	Source current (Pulsed)		120	A
P_D	Maximum power dissipation		20	W
T_{ch}	Channel temperature		-55 ~ +150	°C
T_{stg}	Storage temperature		-55 ~ +150	°C
V_{iso}	Isolation voltage	AC for 1minute, Terminal to case	2000	V
—	Weight	Typical value	2.0	g

FS30KMH-03

HIGH-SPEED SWITCHING USE

ELECTRICAL CHARACTERISTICS (T_{ch} = 25°C)

Symbol	Parameter	Test conditions	Limits			Unit
			Min.	Typ.	Max.	
V (BR) DSS	Drain-source breakdown voltage	I _D = 1mA, V _{GS} = 0V	30	—	—	V
I _{GSS}	Gate-source leakage current	V _{GS} = ±10V, V _{DS} = 0V	—	—	±0.1	μA
I _{DSS}	Drain-source leakage current	V _{DS} = 30V, V _{GS} = 0V	—	—	0.1	mA
V _{GS} (th)	Gate-source threshold voltage	I _D = 1mA, V _{DS} = 10V	0.6	0.9	1.2	V
r _{DS} (ON)	Drain-source on-state resistance	I _D = 15A, V _{GS} = 4V	—	34	46	mΩ
r _{DS} (ON)	Drain-source on-state resistance	I _D = 15A, V _{GS} = 2.5V	—	43	69	mΩ
V _{DS} (ON)	Drain-source on-state voltage	I _D = 15A, V _{GS} = 4V	—	0.51	0.69	V
y _{fs}	Forward transfer admittance	I _D = 15A, V _{DS} = 5V	—	23	—	S
C _{iss}	Input capacitance	V _{DS} = 10V, V _{GS} = 0V, f = 1MHz	—	1150	—	pF
C _{oss}	Output capacitance		—	260	—	pF
C _{rss}	Reverse transfer capacitance		—	120	—	pF
t _d (on)	Turn-on delay time	Channel to case I _S = 15A, dis/dt = -50A/μs	—	19	—	ns
t _r	Rise time		—	95	—	ns
t _d (off)	Turn-off delay time		—	90	—	ns
t _f	Fall time		—	100	—	ns
V _{SD}	Source-drain voltage		—	1.0	1.5	V
R _{th} (ch-c)	Thermal resistance		—	—	6.25	°C/W
t _{rr}	Reverse recovery time		—	45	—	ns

PERFORMANCE CURVES

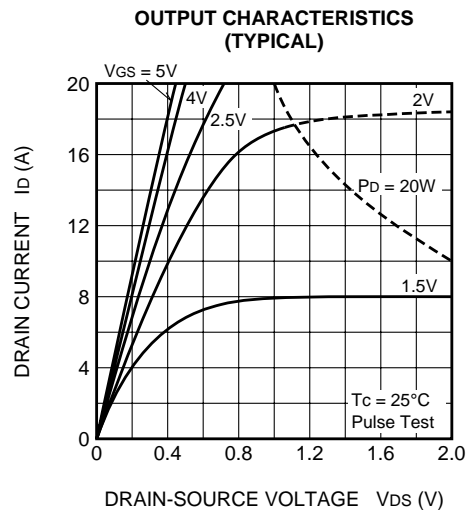
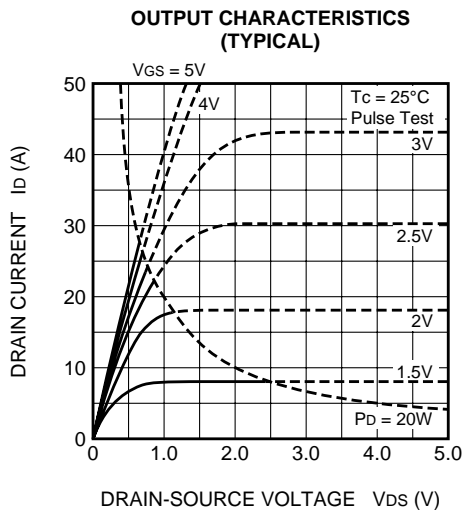
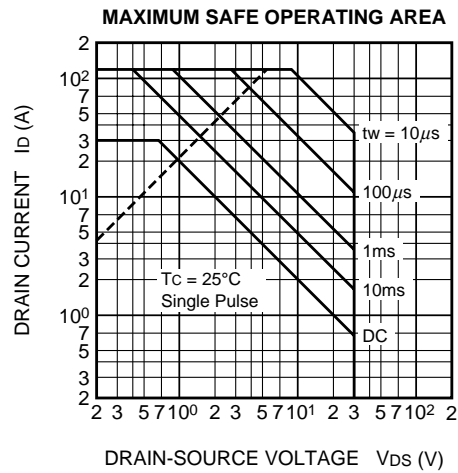
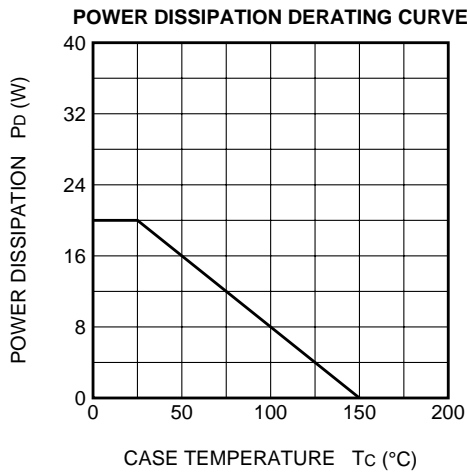

ON-STATE VOLTAGE VS. GATE-SOURCE VOLTAGE (TYPICAL)

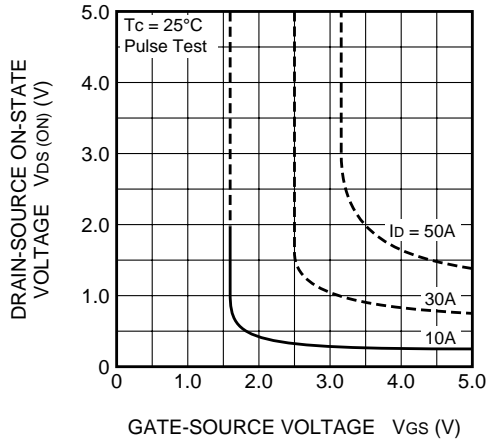

ON-STATE RESISTANCE VS. DRAIN CURRENT (TYPICAL)

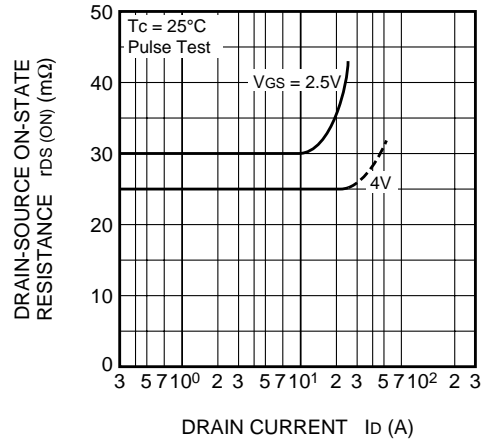

TRANSFER CHARACTERISTICS (TYPICAL)

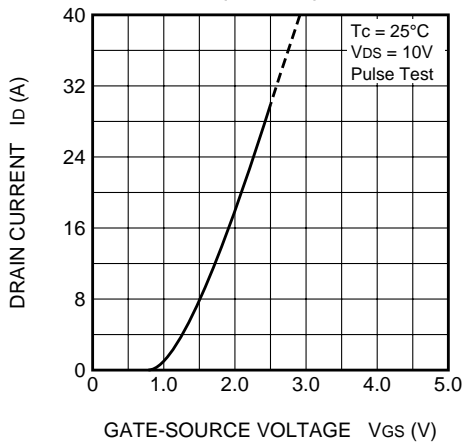

FORWARD TRANSFER ADMITTANCE VS. DRAIN CURRENT (TYPICAL)

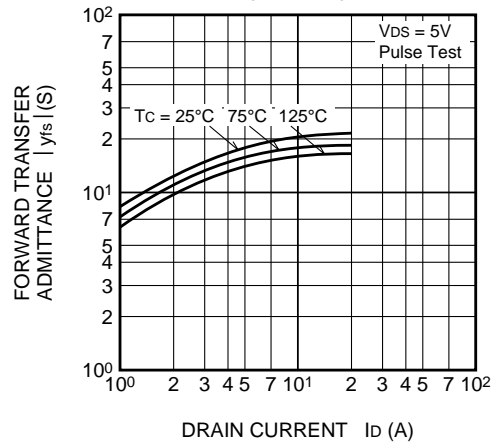

CAPACITANCE VS. DRAIN-SOURCE VOLTAGE (TYPICAL)

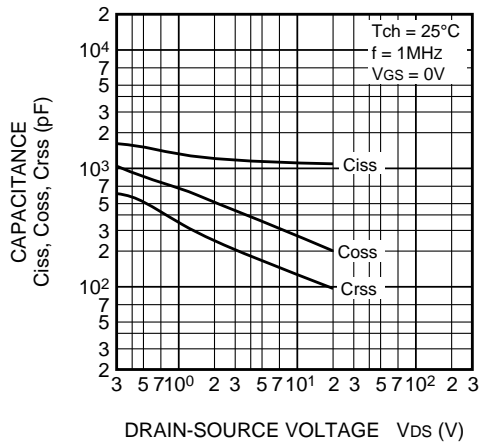

SWITCHING CHARACTERISTICS (TYPICAL)

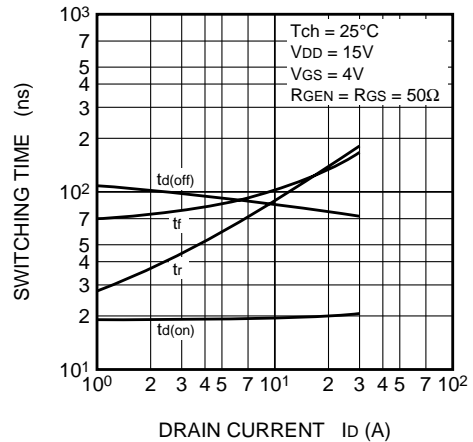

GATE-SOURCE VOLTAGE VS. GATE CHARGE (TYPICAL)

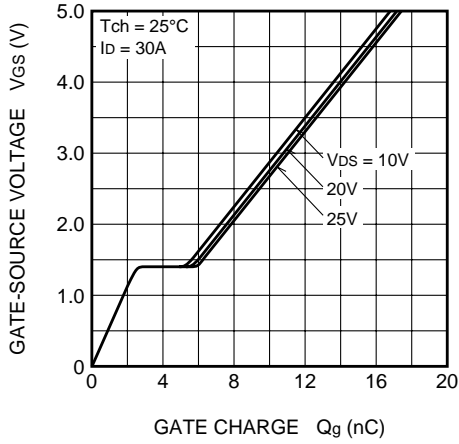

SOURCE-DRAIN DIODE FORWARD CHARACTERISTICS (TYPICAL)

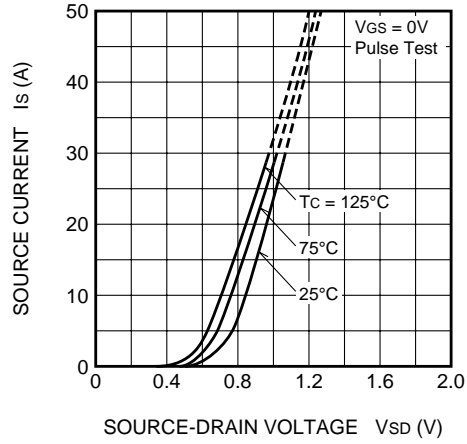

ON-STATE RESISTANCE VS. CHANNEL TEMPERATURE (TYPICAL)

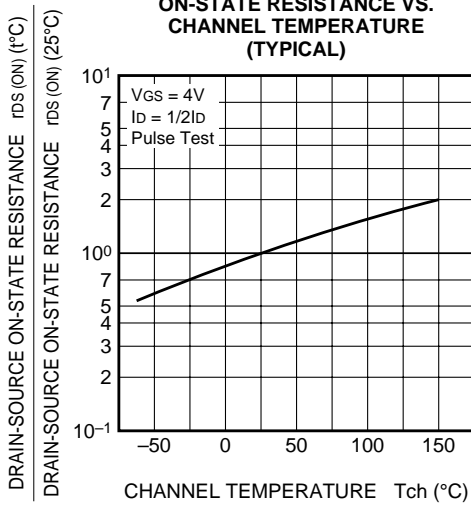

THRESHOLD VOLTAGE VS. CHANNEL TEMPERATURE (TYPICAL)

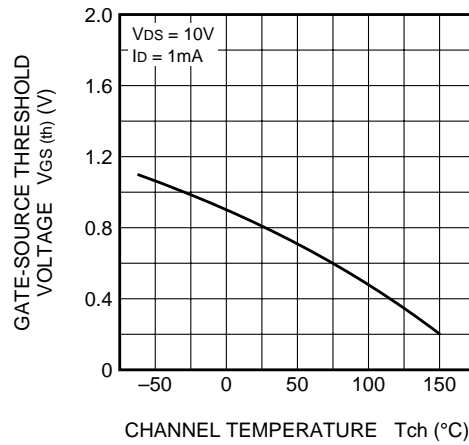

BREAKDOWN VOLTAGE VS. CHANNEL TEMPERATURE (TYPICAL)

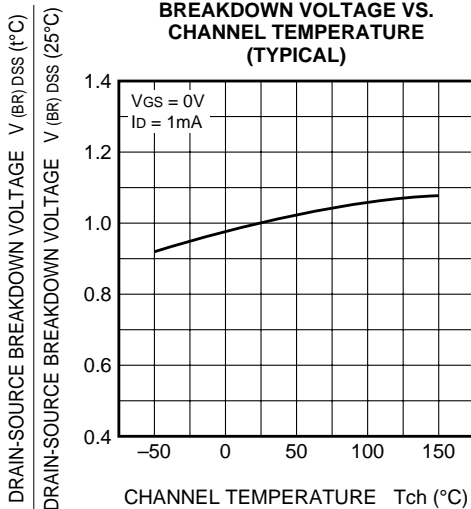

TRANSIENT THERMAL IMPEDANCE CHARACTERISTICS

