

128XRGB128CSTN

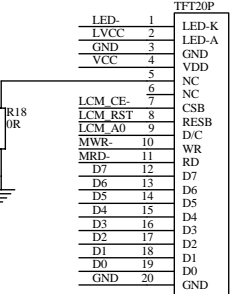

128X160 1.8TFT

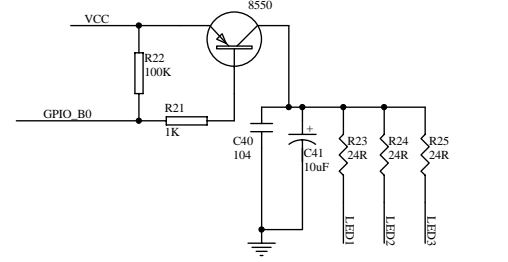
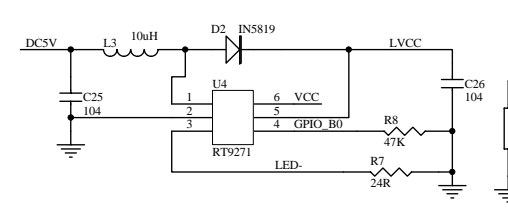
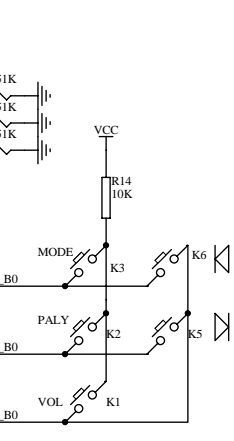
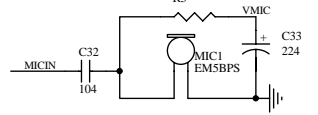
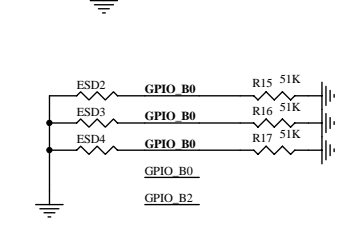
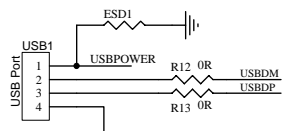
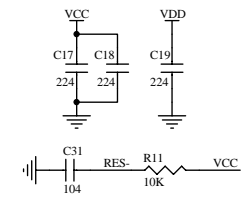
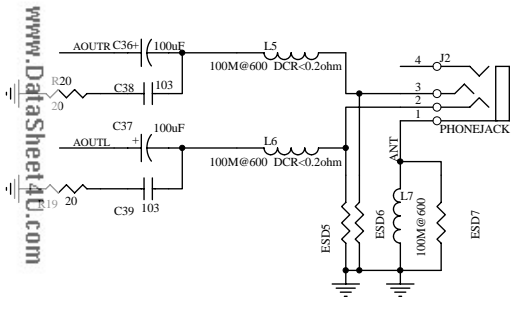
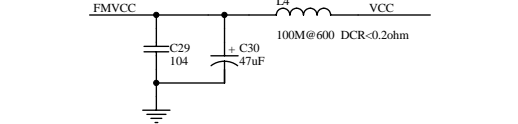
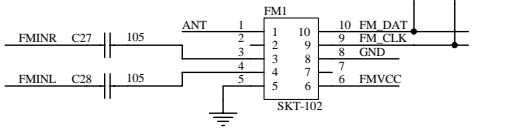
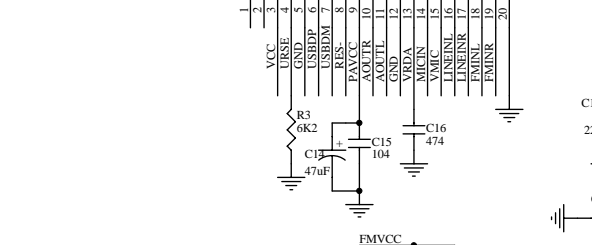
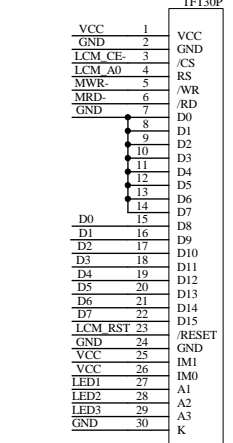
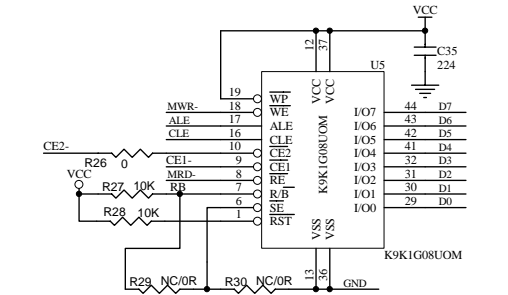

128160/HX8310A

源代码公模
SCC93-002 苹果宝捷

- 1.如果使用瑞萨flash, R28必须焊接.
- 2.如果使用单片选flash, R26和R29不需要焊接, R30需要焊接.
- 3.如果使用双片选flash, R26和R29必须焊接, R30不要焊接.