

## On-Screen Display with Auto-Sizing Controller

### FEATURES

- Horizontal SYNC input up to 150 KHz.
- On-chip PLL circuitry up to 150 MHz.
- Minimum timing measurement among HFLB, VFLB, RIN, GIN and BIN for auto sizing.
- Full screen self-test pattern generator.
- Programmable Hor. resolutions up to 1524 dots per line.
- Full-screen display consists of 15 (rows) by 30 (columns)
- Two font size 12x16 or 12x18 dot matrix per character.
- True totally 512 mask ROM fonts including 496 standard fonts and 16 multi-color fonts.
- Double character height and/or width control.
- Programmable positioning for display screen center.
- Character bordering, shadowing and blinking effect.
- Programmable character height (18 to 71 lines) control.
- Row to row spacing control to avoid expansion distortion.
- 4 programmable windows with multi-level operation.
- Shadowing on windows with programmable shadow width/height/color.
- Programmable adaptive approach to handle H, V sync collision automatically by hardware.
- Software clears bit for full-screen erasing.
- Fade-in/fade-out or blending-in/blending-out effects.
- 5-channel/8-bit PWM D/A converter output.
- Compatible with SPI bus or I<sup>2</sup>C interface with slave address 7AH/7BH (slave address is mask option).
- 16-pin, 20-pin or 24-pin PDIP package.

### GENERAL DESCRIPTION

MTV030 is designed for monitor applications to display built-in characters or fonts onto monitor screens. The display operation occurs by transferring data and control information from the micro-controller to RAM through a serial data interface. It can execute full-screen display automatically, as well as specific functions such as character background, bordering, shadowing, blinking, double height and width, font by font color control, frame positioning, frame size control by character height and row-to-row spacing, horizontal display resolution, full-screen erasing, fade-in/fade-out effect, windowing effect, shadowing on window and full-screen self-test pattern generator.

MTV030 provides true 512 fonts including 496 standard fonts and 16 multi-color fonts and 2 font sizes, 12x16 or 12x18 for more efficacious applications. So each one of the 512 fonts can be displayed at the same time. The full OSD menu is formed by 15 rows x 30 columns, which can be positioned anywhere on the monitor screen by changing vertical or horizontal delay.

The auto sizing video measurement module measure the timing relationship among HFLB, VFLB, and R, G, BIN at the speed related to the OSD resolution. MCU can get the measurement data, active video, front porth and back porth, through I<sup>2</sup>C bus read/write operation to keep the appropriate display size and center.

### BLOCK DIAGRAM

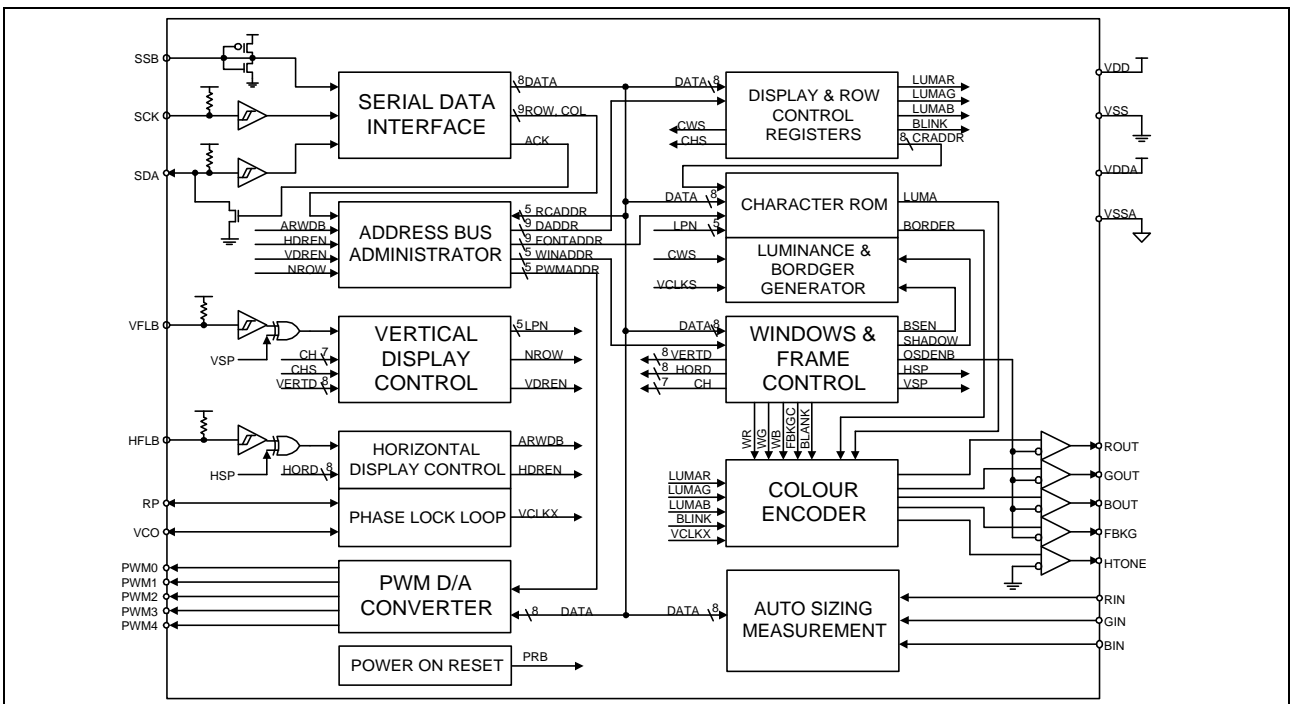

This datasheet contains new product information. Myson Technology reserves the rights to modify the product specification without notice. No liability is assumed as a result of the use of this product. No rights under any patent accompany the sales of the product.

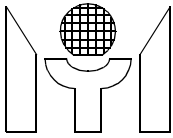

## 1.0 PIN CONNECTION

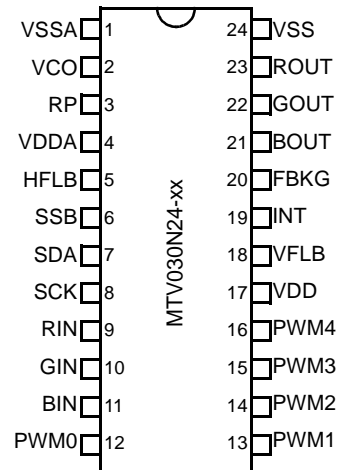
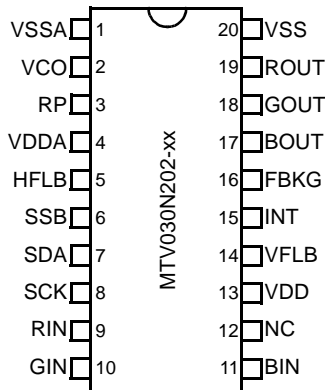
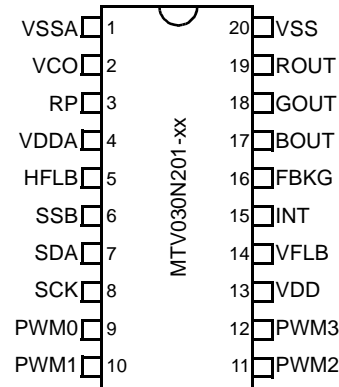
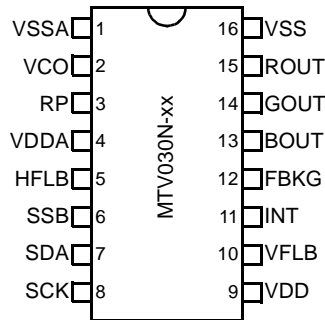

## 2.0 PIN DESCRIPTIONS

Name	I/O	Pin No.				Descriptions
		N16	N201	N202	N24	
VSSA	-	1	1	1	1	<b>Analog ground.</b> This ground pin is used to internal analog circuitry.
VCO	I/O	2	2	2	2	<b>Voltage Control Oscillator.</b> This pin is used to control the internal oscillator frequency by DC voltage input from external low pass filter.
RP	I/O	3	3	3	3	<b>Bias Resistor.</b> The bias resistor is used to regulate the appropriate bias current for internal oscillator to resonate at specific dot frequency.
VDDA	-	4	4	4	4	<b>Analog power supply.</b> Positive 5 V DC supply for internal analog circuitry. And a 0.1uF decoupling capacitor should be connected across to VDDA and VSSA.
HFLB	I	5	5	5	5	<b>Horizontal input.</b> This pin is used to input the horizontal synchronizing signal. It is a leading edge triggered and has an internal pull-up resistor.

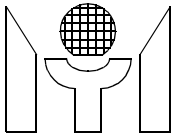

Name	I/O	Pin No.				Descriptions
		N16	N201	N202	N24	
SSB	I	6	6	6	6	<b>Serial interface enable.</b> It is used to enable the serial data and is also used to select the operation of I <sup>2</sup> C or SPI bus. If this pin is left floating, I <sup>2</sup> C bus is enabled, otherwise the SPI bus is enabled.
SDA	I	7	7	7	7	<b>Serial data input.</b> The external data transfer through this pin to internal display registers and control registers. It has an internal pull-up resistor.
SCK	I	8	8	8	8	<b>Serial clock input.</b> The clock-input pin is used to synchronize the data transfer. It has an internal pull-up resistor.
RIN	I	-	-	9	9	<b>Red video input.</b> It is used for auto sizing measurement and this signal is came from video pre-amp red output.
GIN	I	-	-	10	10	<b>Green video input.</b> It is used for auto sizing measurement and this signal is came from video pre-amp green output.
BIN	I	-	-	11	11	<b>Blue video input.</b> It is used for auto sizing measurement and this signal is came from video pre-amp blue output.
NC	-	-	-	12	-	No connection.
PWM0	O	-	9	-	12	<b>Open-Drain PWM D/A converter 0.</b> The output pulse width is programmable by the register of Row 15, Column 23.
PWM1	O	-	10	-	13	<b>Open-Drain PWM D/A converter 1.</b> The output pulse width is programmable by the register of Row 15, Column 24.
PWM2	O	-	11	-	14	<b>Open-Drain PWM D/A converter 2.</b> The output pulse width is programmable by the register of Row 15, Column 25.
PWM3	O	-	12	-	15	<b>Open-Drain PWM D/A converter 3.</b> The output pulse width is programmable by the register of Row 15, Column 26.
PWM4	O	-	-	-	16	<b>Open-Drain PWM D/A converter 4.</b> The output pulse width is programmable by the register of Row 15, Column 27.
VDD	-	9	13	13	17	<b>Digital power supply.</b> Positive 5 V DC supply for internal digital circuitry and a 0.1uF decoupling capacitor should be connected across to VDD and VSS.
VFLB	I	10	14	14	18	<b>Vertical input.</b> This pin is used to input the vertical synchronizing signal. It is leading triggered and has an internal pull-up resistor.
INT	O	11	15	15	19	<b>Intensity color output.</b> 16-color selection is achievable by combining this intensity pin with R/G/B output pins.
FBKG	O	12	16	16	20	<b>Fast Blanking output.</b> It is used to cut off external R, G, B signals of VGA while this chip is displaying characters or windows.
BOUT	O	13	17	17	21	<b>Blue color output.</b> It is a blue color video signal output.
GOUT	O	14	18	18	22	<b>Green color output.</b> It is a green color video signal output.
ROUT	O	15	19	19	23	<b>Red color output.</b> It is a red color video signal output.
VSS	-	16	20	20	24	<b>Digital ground.</b> This ground pin is used to internal digital circuitry.

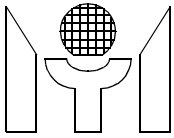

**3.0 FUNCTIONAL DESCRIPTIONS**

**3.1 SERIAL DATA INTERFACE**

The serial data interface receives data transmitted from an external controller. And there are 2 types of bus can be accessed through the serial data interface, one is SPI bus and other is I<sup>2</sup>C bus.

**3.1.1 SPI bus**

While SSB pin is pulled to "high" or "low" level, the SPI bus operation is selected. And a valid transmission should be starting from pulling SSB to "low" level, enabling MTV030 to receiving mode, and retain "low" level until the last cycle for a complete data packet transfer. The protocol is shown in Figure 1.

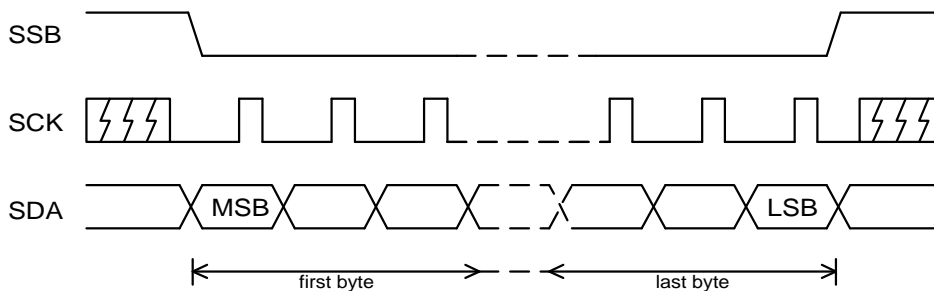

**FIGURE 1. Data Transmission Protocol (SPI)**

There are three transmission formats shown as below:

Format (a) R - C - D → R - C - D → R - C - D .....

Format (b) R - C - D → C - D → C - D → C - D .....

Format (c) R - C - D → D → D → D → D → D .....

Where R=Row address, C=Column address, D=Display data

**3.1.2 I<sup>2</sup>C bus**

I<sup>2</sup>C bus operation is only selected when SSB pin is left floating. And a valid transmission should be starting from writing the slave address 7AH(write mode), or 7BH(read mode) to MTV030. The protocol is shown in Figure 2. And the auto sizing video measurement data (total 10 bytes) are read only registers and the others are write only registers.

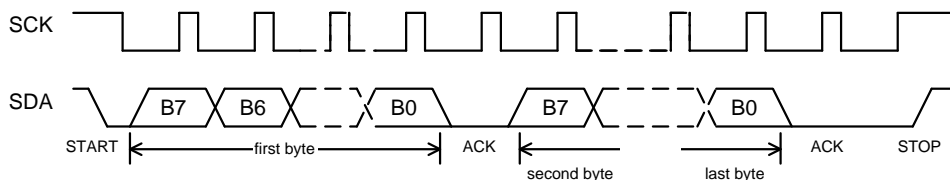

**FIGURE 2. Data Transmission Protocol (I<sup>2</sup>C)**

There are three transmission formats for I<sup>2</sup>C write mode shown as below:

Format (a) S - R - C - D → R - C - D → R - C - D .....

Format (b) S - R - C - D → C - D → C - D → C - D .....

Format (c) S - R - C - D → D → D → D → D → D .....

Where S=Slave address, R=Row address, C=Column address, D=Display data

And there is one transmission format for I<sup>2</sup>C read mode shown as below:

Format (a) S → D → D → D → D → D → D → D → D → D → D → dummy D → dummy D .....

Where S=Slave address, D=Measurement data

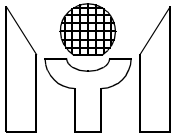

In the I<sup>2</sup>C read mode, 10 bytes of auto sizing video measurement data will be output directly from byte 0 to byte 9 and continues with dummy data until stop condition occurred when I<sup>2</sup>C R/W bit is set to "1".

Each arbitrary length of data packet consists of 3 portions viz, Row address (R), Column address (C), and Display data (D). Format (a) is suitable for updating small amount of data which will be allocated with different row address and column address. Format (b) is recommended for updating data that has same row address but different column address. Massive data updating or full screen data change should use format (c) to increase transmission efficiency. The row and column address will be incremented automatically when the format (c) is applied. Furthermore, the undefined locations in display or fonts RAM should be filled with dummy data.

**TABLE 1.** The configuration of transmission formats.

	Address	b7	b6	b5	b4	b3	b2	b1	b0	Format
<b>Address Bytes of Display Reg.</b>	Row	1	0	0	R4	R3	R2	R1	R0	a,b,c
	Column <sub>ab</sub>	0	0	<b>D8</b>	C4	C3	C2	C1	C0	a,b
	Column <sub>c</sub>	0	1	<b>D8</b>	C4	C3	C2	C1	C0	c
	Data	D7	D6	D5	D4	D3	D2	D1	D0	a,b,c
<b>Attribute Bytes of Display Reg.</b>	Row	1	0	1	R4	R3	R2	R1	R0	a,b,c
	Column <sub>ab</sub>	0	0	x	C4	C3	C2	C1	C0	a,b
	Column <sub>c</sub>	0	1	x	C4	C3	C2	C1	C0	c
	Data	D7	D6	D5	D4	D3	D2	D1	D0	a,b,c

There are 2 types of data should be accessed through the serial data interface, one is **ADDRESS** bytes of display registers, and other is **ATTRIBUTE** bytes of display registers, the protocol are same for all except the bit5 of row address and the bit5 of column address. The MSB(b7) is used to distinguish row and column addresses when transferring data from external controller. The bit6 of column address is used to differentiate the column address for format (a), (b) and format (c) respectively. Bit5 of row address for display register is used to distinguish ADDRESS byte when it is set to "0" and ATTRIBUTE byte when it is set to "1". And **at address bytes, bit5 of column address is the MSB (bit8) and data bytes are the 8 LSB (bit7~bit0) of display fonts address** to save half MCU memory for true 512 fonts. So each one of the 512 fonts can be displayed at the same time. See Table 1. And for format (c), since D8 is filled while program column address of address bytes, the continued data will be the same bank of upper 256 fonts or lower 256 fonts until program column address of address bytes again.

The data transmission is permitted to change from format (a) to format (b) and (c), or from format (b) to format (a) and (c), but not from format (c) back to format (a) and (b). The alternation between transmission formats is configured as the state diagram shown in Figure 3.

### 3.2 Address bus administrator

The administrator manages bus address arbitration of internal registers or user fonts RAM during external data write in. The external data write through serial data interface to registers must be synchronized by internal display timing. In addition, the administrator also provides automatic increment to address bus when external write using format (c).

### 3.3 Vertical display control

The vertical display control can generates different vertical display sizes for most display standards in current monitors. The vertical display size is calculated with the information of double character height bit(CHS), verti-

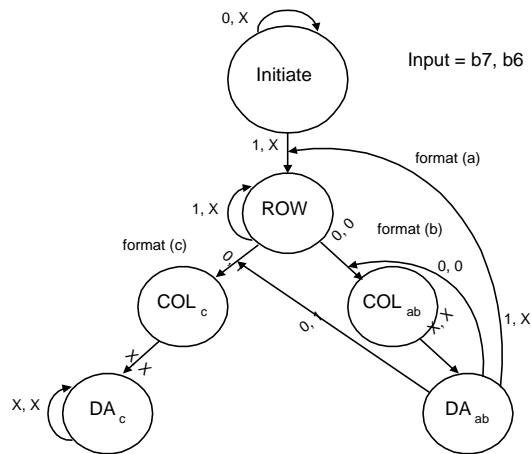
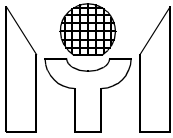

**FIGURE 3. Transmission State Diagram**

cal display height control register(CH6-CH0).The algorithm of repeating character line display are shown as Table 2 and Table 3. The programmable vertical size range is 270 lines to maximum 2130 lines.

The vertical display center for full screen display could be figured out according to the information of vertical starting position register (VERTD) and VFLB input. The vertical delay starting from the leading edge of VFLB, is calculated with the following equation:

Vertical delay time = ( VERTD \* 4 + 1 ) \* H

Where H = one horizontal line display time

**TABLE 2. Repeat line weight of character**

CH6 - CH0	Repeat Line Weight
CH6,CH5=11	+18*3
CH6,CH5=10	+18*2
CH6,CH5=0x	+18
CH4=1	+16
CH3=1	+8
CH2=1	+4
CH1=1	+2
CH0=1	+1

**TABLE 3. Repeat line number of character**

Repeat Line Weight	Repeat Line #																	
	0	1	2	3	4	5	6	7	8	9	10	11	12	13	14	15	16	17
+1	-	-	-	-	-	-	-	-	v	-	-	-	-	-	-	-	-	-
+2	-	-	-	-	v	-	-	-	-	-	-	-	v	-	-	-	-	-
+4	-	-	v	-	-	-	v	-	-	-	v	-	-	-	v	-	-	-
+8	-	v	-	v	-	v	-	v	-	v	-	v	-	v	-	v	-	-
+16	-	v	v	v	v	v	v	v	v	v	v	v	v	v	v	v	v	-
+17	v	v	v	v	v	v	v	v	v	v	v	v	v	v	v	v	v	-
+18	v	v	v	v	v	v	v	v	v	v	v	v	v	v	v	v	v	v

Note: " v " means the nth line in the character would be repeated once, while " - " means the nth line in the character would not be repeated.

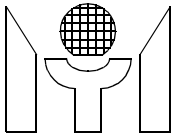

### 3.4 Horizontal display control

The horizontal display control is used to generate control timing for horizontal display based on double character width bit (CWS), horizontal positioning register (HORD), horizontal resolution register (HORR), and HFLB input. A horizontal display line consists of (HORR\*12) dots which include 360 dots for 30 display characters and the remaining dots for blank region. The horizontal delay starting from HFLB leading edge is calculated with the following equation,

$$\text{Horizontal delay time} = (\text{HORD} * 6 + 49) * P - \text{phase error detection pulse width}$$

Where P = One pixel display time = One horizontal line display time / (HORR\*12)

### 3.5 Phase lock loop (PLL)

On-chip PLL generates system clock timing (VCLK) by tracking the input HFLB and horizontal resolution register (HORR). The frequency of VCLK is determined by the following equation:

$$\text{VCLK Freq} = \text{HFLB Freq} * \text{HORR} * 12$$

The VCLK frequency ranges from 6MHz to 150MHz selected by (VCO1, VCO0). In addition, when HFLB input is not present to MTV030, the PLL will generate a specific system clock, approximately 2.5MHz, by a built-in oscillator to ensure data integrity.

### 3.6 Display & Row control registers

The internal RAM contains display and row control registers. The display registers have 450 locations which are allocated between (row 0, column 0) to (row 14, column 29), as shown in Figure 4 and Figure 5. Each display register has its corresponding character address on ADDRESS byte, its corresponding background color, 1 blink bit and its corresponding color bits on ATTRIBUTE bytes. The row control register is allocated at column 30 for row 0 to row 14 of attribute bytes, it is used to set character size to each respective row. If double width character is chosen, only even column characters could be displayed on screen and the odd column characters will be hidden.

ROW #	COLUMN #						
	0	1	28	29	30	31	
0	CHARACTER ADDRESS BYTES of DISPLAY REGISTERS					ROW ATTRIBUTE CTRL REG	R
1							E
							S
							E
							R
							V
							E
							D
13							
14							

**FIGURE 4. Address Bytes of Display Registers Memory Map**

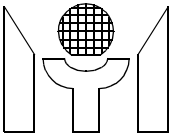

ROW #	COLUMN #					
	0	1	28	29	30	31
0	CHARACTER ATTRIBUTE BYTES of DISPLAY REGISTERS					RESERVED
1						
13						
14						

ROW 15	COLUMN#						
	0	11	12	22	23	27	28
	WINDOW1 ~ WINDOW4		FRAME CRTL REG	PWM D/A CRTL REG	RESERVED		

ROW 16	COLUMN#			
	0	1	2	31
	WINDOW SHADOW COLOR		RESERVED	

**FIGURE 5. Attribute Bytes of Display Registers Memory Map**

**ADDRESS BYTES:**

Address registers,

b8	b7	b6	b5	b4	b3	b2	b1	b0
CRADDR								
MSB								LSB

CRADDR - Define ROM character address from address 0 to 511.

Row Control Registers, (Row 0 - 14)

COLN 30	b7	b6	b5	b4	b3	b2	b1	b0
	-	-	-	-	-	-	CHS	CWS

CHS - Define double height character to the respective row.

CWS - Define double width character to the respective row.

**ATTRIBUTE BYTES:**

b7	b6	b5	b4	b3	b2	b1	b0
-	BGR	BGG	BGB	BLINK	R	G	B

BGR, BGG, BGB - These three bits define the color of the background for its relative address character. If all three bits are clear, no background will be shown(transparent). Therefore, total 7 background color can be selected.

BLINK - Enable blinking effect while this bit is set to " 1 ". And the blinking is alternate per 32 vertical frames.

R, G, B - These three bits are used to specify its relative address character color.



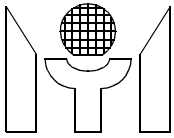

### 3.7 Character ROM

MTV030 character ROM contains 512 built-in characters and symbols including 496 standard fonts and 16 multi-color fonts. The 496 standard fonts are located from address 0 to 495. And the 16 multi-color fonts are located from address 496 to 511. Each character and symbol consists of 12x18 dots matrix. The detail pattern structures for each character and symbols are shown in “CHARACTERS AND SYMBOLS PATTERN” on page 21.

### 3.8 Multi-Color Font

The color fonts comprises three different R, G, B fonts. When the code of color font is accessed, the separate R/G/B dot pattern is output to corresponding R/G/B output. See Figure 6 for the sample displayed color font. Note: No black color can defined in color font, black window underline the color font can make the dots become black in color. The detail pattern structures for each character and symbols are shown in “CHARACTERS AND SYMBOLS PATTERN” on page 21.

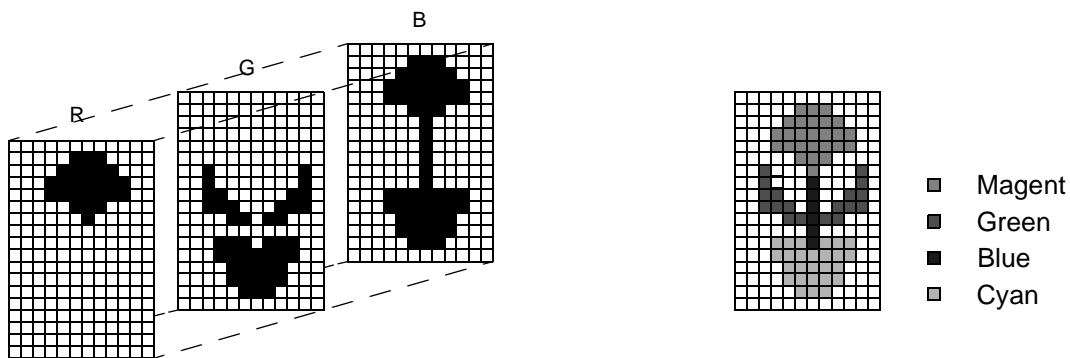

**FIGURE 6. Example of Multi-Color Font**

**TABLE 4. The Multi-Color Font Color Selection**

	<b>R</b>	<b>G</b>	<b>B</b>
Background Color	0	0	0
Blue	0	0	1
Green	0	1	0
Cyan	0	1	1
Red	1	0	0
Magent	1	0	1
Yellow	1	1	0
White	1	1	1

### 3.9 Luminance & border generator

There are 3 shift registers included in the design which can shift out of luminance and border dots to color encoder. The bordering and shadowing feature is configured in this block. For bordering effect, the character will be enveloped with blackedge on four sides. For shadowing effect, the character is enveloped with blackedge for right and bottom sides only.

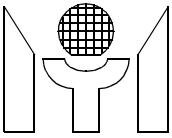

**3.10 Window and frame control**

The display frame position is completely controlled by the contents of VERTD and HORD. The window size and position control are specified in column 0 to 11 on row 15 of memory map, as shown in Figure 5. Window 1 has the highest priority, and window 4 is the least, when two windows are overlapping. More detailed information is described as follows:

1. Window control registers,  
ROW 15

<b>Column 0,3,6,OR 9</b>	b7	b6	b5	b4	b3	b2	b1	b0
	ROW START ADDR				ROW END ADDR			
	MSB				LSB			

<b>Column 1,4,7,OR 10</b>	b7	b6	b5	b4	b3	b2	b1	b0
	COL START ADDR					WEN	-	WSHD
	MSB					LSB		

<b>Column 2,5,8,OR 11</b>	b7	b6	b5	b4	b3	b2	b1	b0
	COL END ADDR					R	G	B
	MSB					LSB		

START(END) ADDR - These addresses are used to specify the window size. It should be noted that when the start address is greater than the end address, the window will be disabled.

WEN - Enable the relative background window display.

WSHD - Enable shadowing on the window.

R, G, B - Specify the color of the relative background window.

2. Frame control registers,  
ROW 15

<b>Column 12</b>	b7	b6	b5	b4	b3	b2	b1	b0
	VERTD							
	MSB							
	LSB							

VERTD - Specify the starting position for vertical display. The total steps are 256, and the increment of each step is 4 Horizontal display lines. The initial value is 4 after power up.

<b>Column 13</b>	b7	b6	b5	b4	b3	b2	b1	b0
	HORD							
	MSB							
	LSB							

HORD - Define the starting position for horizontal display. The total steps are 256, and the increment of each step is 6 dots. The initial value is 15 after power up.

<b>Column 14</b>	b7	b6	b5	b4	b3	b2	b1	b0
	-	CH6	CH5	CH4	CH3	CH2	CH1	CH0

CH6-CH0 - Define the character vertical height, the height is programmable from 18 to 71 lines. The character vertical height is at least 18 lines if the contents of CH6-CH0 is less than 18. For example, when the contents is " 2 ", the character vertical height is regarded as equal to 20 lines. And if the con-

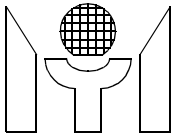

tents of CH4-CH0 is greater than or equal to 18, it will be regarded as equal to 17. See Table 2 and Table 3 for detail description of this operation.

	b7	b6	b5	b4	b3	b2	b1	b0
<b>Column 15</b>	-	HORR						
		MSB						

**HORR** - Specify the resolution of a horizontal display line, and the increment of each step is 12 dots. That is, the pixels' number per H line equal to HORR\*12. It is recommended that HORR should be greater than or equal to 36 and smaller than 150M / (Hfreq\*12). The initial value is 40 after power up.

	b7	b6	b5	b4	b3	b2	b1	b0
<b>Column 16</b>	-	-	-	RSPACE				
				MSB				

**RSPACE** - Define the row to row spacing in unit of horizontal line. That is, extra RSPACE horizontal lines will be appended below each display row, and the maximum space is 31 lines. The initial value is 0 after power up.

	b7	b6	b5	b4	b3	b2	b1	b0
<b>Column 17</b>	OSDEN	BSEN	SHADOW	FBEN	BLEND	WENCLR	RAMCLR	FBKGC

**OSDEN** - Activate the OSD operation when this bit is set to "1". The initial value is 0 after power up.

**BSEN** - Enable the bordering and shadowing effect.

**SHADOW** - Bordering and shadowing effect select bit. Activate the shadowing effect if this bit is set, otherwise the bordering is chosen.

**FBEN** - Enable the fade-in/fade-out and blending-in/blending-out effect when OSD is turned on from off state or vice versa.

**BLEND** - Fade-in/fade-out and blending-in/blending-out effect select bit. Activate the blending-in/blending-out function if this bit is set, otherwise the fade-in/fade-out function is chosen. These function roughly takes about 0.5 second to fully display the whole menu or to disappear completely.

**WENCLR** - Clear all WEN bits of window control registers when this bit is set to "1". The initial value is 0 after power up.

**RAMCLR** - Clear all ADDRESS bytes, BGR, BGG, BGB and BLINK bits of display registers when this bit is set to "1". The initial value is 0 after power up.

**FBKGC** - Define the output configuration for FBKG pin. When it is set to "0", the FBKG outputs high during the displaying of characters or windows, otherwise, it outputs high only during the displaying of character.

	B7	b6	b5	b4	b3	b2	b1	b0
<b>Column 18</b>	TRIC	FSS	VMEN	SELVCL	HSP	VSP	VCO1	VCO0

**TRIC** - Define the driving state of output pins ROUT, GOUT, BOUT and FBKG when OSD is disabled. That is, while OSD is disabled, these four pins will drive low if this bit is set to 1, otherwise these four pins are in high impedance state. The initial value is 0 after power up.

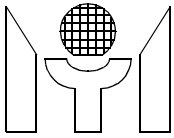

FSS - Font size selection.

= 1 ⇒ 12x18 font size selected.

= 0 ⇒ 12x16 font size selected.

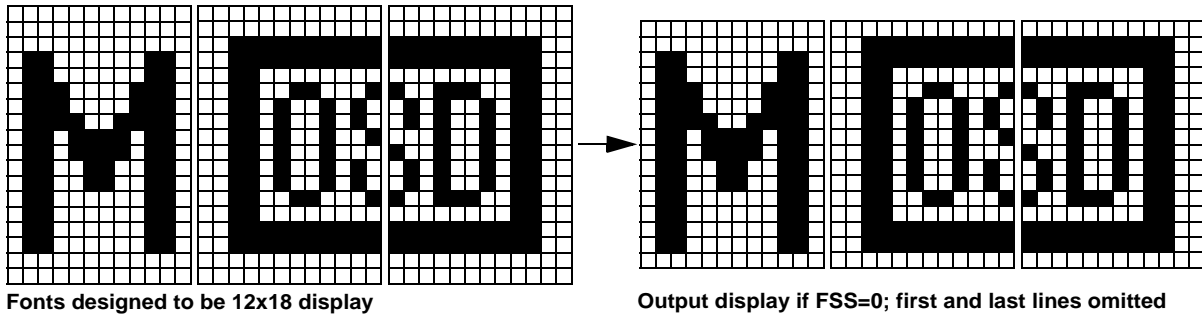

**FIGURE 7. 12x18 and 12x16 Fonts**

VMEN - Auto sizing video measurement enable bit. All video measurements commence at the following VFLB pulse after the VMEN bit is set, complete the measurement after one vertical frame.

SELVCL - Enable auto detection for horizontal and vertical syncs input edge distortion to avoid unstable Vsync leading mismatch with Hsync signal while the bit is set to "1". The initial value is 0 after power up.

HSP - = 1 ⇒ Accept positive polarity Hsync input.  
= 0 ⇒ Accept negative polarity Hsync input.

VSP - = 1 ⇒ Accept positive polarity Vsync input.  
= 0 ⇒ Accept negative polarity Vsync input.

VCO1, VCO0 - Select the appropriate curve partitions of VCO frequency to voltage based on HFLB input and horizontal resolution register (HORR).

- = (0, 0) ⇒ 6 MHz < Pixel rate ≤ 28 MHz
- = (0, 1) ⇒ 28 MHz < Pixel rate ≤ 56 MHz
- = (1, 0) ⇒ 56 MHz < Pixel rate ≤ 112 MHz
- = (1, 1) ⇒ 112 MHz < Pixel rate ≤ 150 MHz

where Pixel rate = VCLK Freq = HFLB Freq \* HORR \* 12  
The initial value is (0, 0) after power up.

**Notes :**

1. That is, if HORR is specified, then (VCO1, VCO0)
  - = (0, 0) if 6000/(HORR \* 12) < HFLB Freq (KHZ) ≤ 28000/(HORR \* 12)
  - = (0, 1) if 28000/(HORR \* 12) < HFLB Freq (KHZ) ≤ 56000/(HORR \* 12)
  - = (1, 0) if 56000/(HORR \* 12) < HFLB Freq (KHZ) ≤ 112000/(HORR \* 12)
  - = (1, 1) if 112000/(HORR \* 12) < HFLB Freq (KHZ) ≤ 150000/(HORR \* 12)
2. It is necessary to wait for the PLL to become stable while (i) the HORR register is changed; (ii) the (VCO1, VCO0) bits is changed; (iii) the horizontal signal (HFLB) is changed.
3. When PLL is unstable, don't write data in any address except Column 15,17,18 of Row 15. If data is written in any other address, a malfunction may occur.

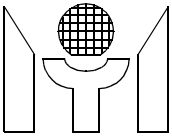

**TABLE 5. PWMCK Frequency and PWMDA sampling rate**

(VCO1, VCO0)	PWMCK Freq (14M ~ 28MHz)	PWMDA sampling rate (54K ~ 109KHz)
(0, 0)	HFLB Freq * HERR * 12	HFLB Freq * HERR * 12 / 256
(0, 1)	HFLB Freq * HERR * 6	HFLB Freq * HERR * 6 / 256
(1, 0)	HFLB Freq * HERR * 3	HFLB Freq * HERR * 3 / 256
(1, 1)	HFLB Freq * HERR * 3 / 2	HFLB Freq * HERR * 3 / 512

<b>Column 19</b>	B7	b6	b5	b4	b3	b2	b1	b0
	-	-	-	-	-	CSR	CSG	CSB

CSR, CSG, CSB - Define the color of bordering or shadowing on characters. The initial value is (0, 0, 0) after power up.

<b>Column 20</b>	B7	b6	b5	b4	b3	b2	b1	b0
	FSW	-	-	-	-	FSR	FSG	FSB

FSW - Enable full screen self-test pattern and force the FBKG pin output to high to disable video RGB while this bit is set to "1". The self-test pattern's color is determined by (FSR, FSG, FSB) bits.

FSR, FSG, FSB - Define the color of full screen self-test pattern.

<b>Column 21</b>	B7	b6	b5	b4	b3	b2	b1	b0
	WW41	WW40	WW31	WW30	WW21	WW20	WW11	WW10

WW41, WW40 - Determines the shadow width of the window 4 when WSHD bit of th window 4 is enabled. Please refer to the Table 6 for more details.

**TABLE 6. Shadow Width Setting**

(WW41, WW40)	(0, 0)	(0, 1)	(1, 0)	(1, 1)
Shadow Width (unit in Pixel)	2	4	6	8

WW31, WW30 - Determines the shadow width of the window 3 when WSHD bit of th window 3 is enabled.

WW21, WW20 - Determines the shadow width of the window 2 when WSHD bit of th window 2 is enabled.

WW11, WW10 - Determines the shadow width of the window 1 when WSHD bit of th window 1 is enabled.

<b>Column 22</b>	B7	b6	b5	b4	b3	b2	b1	b0
	WH41	WH40	WH31	WH30	WH21	WH20	WH11	WH10

WH41, WH40 - Determines the shadow height of the window 4 when WSHD bit of th window 4 is enabled. Please refer to the Table 7 for more details.

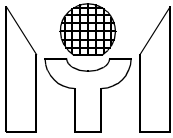

**TABLE 7. Shadow Height Setting**

(WH41, WH40)	(0, 0)	(0, 1)	(1, 0)	(1, 1)
Shadow Height (unit in Line)	2	4	6	8

WH31, WH30 - Determines the shadow height of the window 3 when WSHD bit of th window 3 is enabled.  
 WH21, WH20 - Determines the shadow height of the window 2 when WSHD bit of th window 2 is enabled.  
 WH11, WH10 - Determines the shadow height of the window 1 when WSHD bit of th window 1 is enabled.

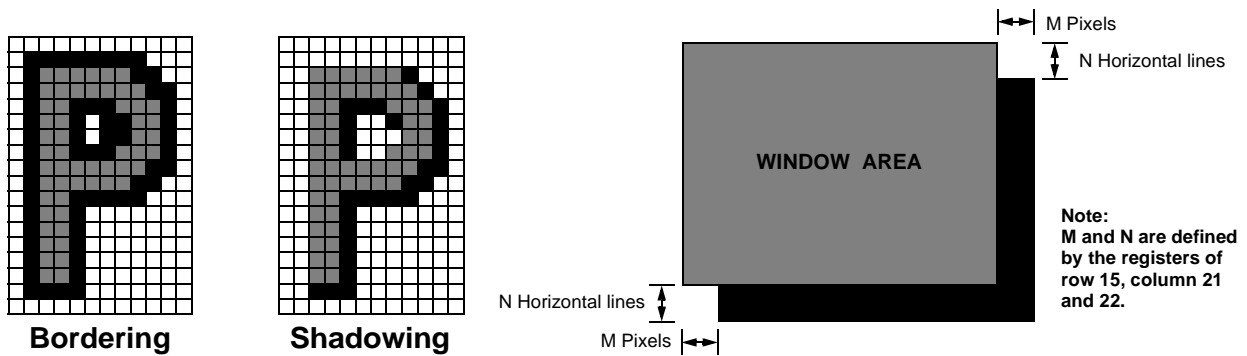

**FIGURE 8. Character Bordering and Shadowing and Shadowing on Window**

### 3.11 Color encoder

The encoder generates the video output to ROUT, GOUT and BOUT by integrating window color, border blackedge, luminance output and color selection output (R, G, B) to form the desired video outputs.

### 3.12 PWM D/A converter

There are 5 open-drain PWM D/A outputs (PWM0 to PWM4). These PWM D/A converter outputs pulse width are programmable by writing data to Column 23 to 27 registers of Row 15 with 8-bit resolution to control the pulse width duration from 0/256 to 255/256. And the sampling rate is selected by (VCO1, VCO0) shown as table 5. In applications, all open-drain output pins should be pulled-up by external resistors to supply voltage (5V to 9V) for desired output range.

	b7	b6	b5	b4	b3	b2	b1	b0
<b>Column 23</b>	PWMDA0							
<b>Column 27</b>								
	MSB				LSB			

PWMDA0 - PWMDA4 - Define the output pulse width of pin PWM0 to PWM4.

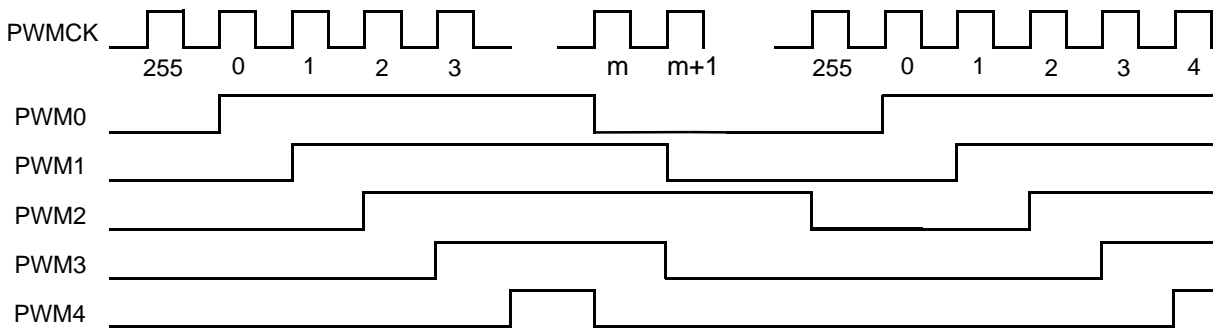
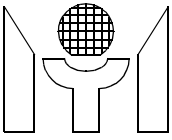

**FIGURE 9. 5 Channel PWM Output Rising Edges Are Separated by One PWMCK**

**Column 28 ~ column 31** : Reserved.

**Notes :** The register located at column 31 of row 15 are reserved for the testing. Don't program this byte anytime in normal operation.

ROW 16

Column 0	B7	b6	b5	b4	b3	b2	b1	b0
	-	R1	G1	B1	-	R2	G2	B2

R1, G1, B1 - Define the shadow color of window 1. The initial value is (0, 0, 0) after power up.

R2, G2, B2 - Define the shadow color of window 2. The initial value is (0, 0, 0) after power up.

Column 1	B7	b6	b5	b4	b3	b2	b1	b0
	-	R3	G3	B3	-	R4	G4	B4

R3, G3, B3 - Define the shadow color of window 3. The initial value is (0, 0, 0) after power up.

R4, G4, B4 - Define the shadow color of window 4. The initial value is (0, 0, 0) after power up.

**Column 2 ~ column 31** : Reserved.

### 3.13 Auto sizing video measurement

The auto sizing video measurement module monitors horizontal and vertical flyback pulses and their relationship to video content. In horizontal measurement, the HFLB is the reference signal. As PLL clock is the certain multiple of HFLB frequency, the measurements for HFLB and R,G,BIN are all based on the PLL clock. In vertical measurement, the VFLB pulse is reference signal and the HFLB is the counting clock. HFLB and VFLB have an exact timing relationship to the active raster display on the monitor. When the HFLB, VFLB sync signals and the R,G,BIN video signals (taken from the output of pre-amplifier) are compared, it will feedback to MCU a lot of information about the display size and centering. If back porch is much smaller than front porth, then the video information is too much to the left (or up in the vertical direction). If both front porth and back porth percentage of the total display period is too large, then the display size is too small. MCU can change the display size and center until front and back porthes are equal and the porthes to active video ratio is correct. Please note that due to the deviation of analog circuits, building a ratio table of correct porches to video for different operating frequencies is needed. And it is recommend that video contrast is set to maximum first for the correct capture of video information.

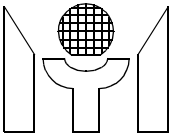

All these measurements commence at the following VFLB pulse after enabling VMEN bit, complete the measurement after one vertical frame, so minimum delay 2 vertical frame time after enabling VMEN bit is needed to read out the measurement data. The horizontal measurement for R,G,BIN will store the minimum start location and the maximum ending location in one vertical frame into registers. All of the input signals for timing measurement are polarity programmable, so the different phase measurement can be obtained.

**Auto sizing video measurement data bytes : read only registers**

<b>Byte 0</b>	B7	b6	b5	b4	b3	b2	b1	b0
	-	-	-	-	-	-	Dhrgbsta MSB	

b1 ~ b0 : The most significant 2 bits of **Dhrgbsta** which represents the distance between the first active edge of R,G,BIN input and reference HFLB leading edge. See Figure 10.

<b>Byte 1</b>	B7	b6	b5	b4	b3	b2	b1	b0
	Dhrgbsta							LSB

b7 ~ b0 : The least significant 8 bits of **Dhrgbsta** which represents the distance between the first active edge of R,G,BIN input and reference HFLB leading edge. See Figure 10.

<b>Byte 2</b>	B7	b6	b5	b4	b3	b2	b1	b0
	-	-	-	-	-	-	Dhrgbend MSB	

b1 ~ b0 : The most significant 2 bits of **Dhrgbend** which represents the distance between the last active edge of R,G,BIN input and reference HFLB leading edge. See Figure 10.

<b>Byte 3</b>	B7	b6	b5	b4	b3	b2	b1	b0
	Dhrgbend							LSB

b7 ~ b0 : The least significant 8 bits of **Dhrgbend** which represents the distance between the last active edge of R,G,BIN input and reference HFLB leading edge. See Figure 10.

<b>Byte 4</b>	B7	b6	b5	b4	b3	b2	b1	b0
	-	-	-	-	-	Dvrgbsta MSB		

b2 ~ b0 : The most significant 3 bits of **Dvrgbsta** which represents the H line distance between the first active line of R,G,BIN input and reference VFLB leading edge. See Figure 10.

<b>Byte 5</b>	B7	b6	b5	b4	b3	b2	b1	b0
	Dvrgbsta							LSB

b7 ~ b0 : The least significant 8 bits of **Dvrgbsta** which represents the H line distance between the first active line of R,G,BIN input and reference VFLB leading edge. See Figure 10.



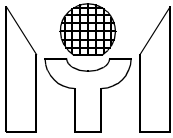

<b>Byte 6</b>	B7	b6	b5	b4	b3	b2	b1	b0
	-	-	-	-	-	Dvrgbend MSB		

b2 ~ b0 : The most significant 3 bits of **Dvrgbend** which represents the H line distance between the last active line of R,G,BIN input and reference VFLB leading edge. See Figure 10.

<b>Byte 7</b>	B7	b6	b5	b4	b3	b2	b1	b0
	Dvrgbend							LSB

b7 ~ b0 : The least significant 8 bits of **Dvrgbend** which represents the H line distance between the last active line of R,G,BIN input and reference VFLB leading edge. See Figure 10.

<b>Byte 8</b>	B7	b6	b5	b4	b3	b2	b1	b0
	-	-	-	-	OVER	Dvsline MSB		

OVER - = 1 ⇒ The line number counter is overflow.  
= 0 ⇒ Not overflow.

b2 ~ b0 : The most significant 3 bits of **Dvsline** which represents the total H line count between two consecutive VFLB pulses. See Figure 10.

<b>Byte 9</b>	B7	b6	b5	b4	b3	b2	b1	b0
	Dvsline							LSB

b7 ~ b0 : The least significant 8 bits of **Dvsline** which represents the total H line count between two consecutive VFLB pulses. See Figure 10.

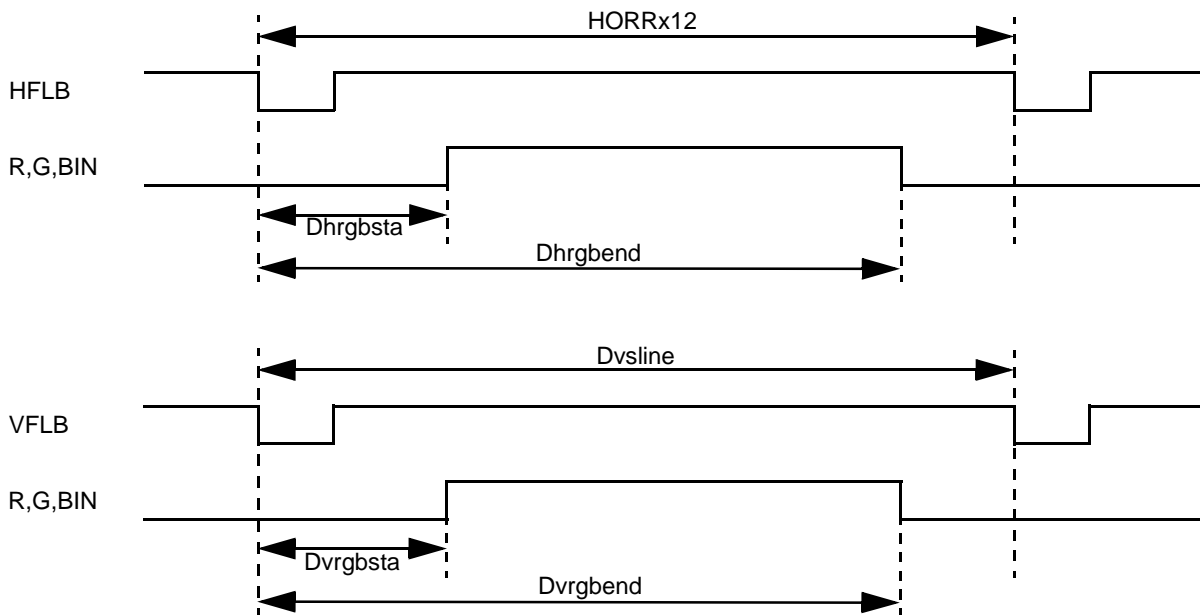
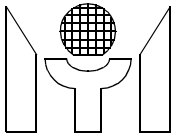

**FIGURE 10. Timing Diagram of Auto Sizing Video Measurement**

**4.0 ABSOLUTE MAXIMUM RATINGS**

DC Supply Voltage(VDD,VDDA)	-0.3 to +7 V
Voltage with respect to Ground	-0.3 to VDD+0.3 V
Storage Temperature	-65 to +150 °C
Ambient Operating Temperature	0 to +70 °C

**5.0 OPERATING CONDITIONS**

DC Supply Voltage(VDD,VDDA)	+4.75 to +5.25 V
Operating Temperature	0 to +70 °C

**6.0 ELECTRICAL CHARACTERISTICS (Under Operating Conditions)**

Symbol	Parameter	Conditions (Notes)	Min.	Max.	Units
V <sub>IH</sub>	Input High Voltage (pin hflb, vflb, sda, sck, ssb)	-	0.7 * VDD	VDD+0.3	V
	Input High Voltage (pin rin, gin, bin)	-	0.7 * VDD	VDD+0.3	V

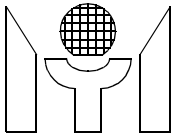

Symbol	Parameter	Conditions (Notes)	Min.	Max.	Units
V <sub>IL</sub>	Input Low Voltage (pin hflb, vflb, sda, sck)	-	VSS-0.3	0.3 * VDD	V
	Input Low Voltage (pin ssb)	-	VSS-0.3	0.2 * VDD	V
	Input Low Voltage (pin rin, gin, bin)	-	VSS-0.3	0.6 * VDD	V
V <sub>OH</sub>	Output High Voltage	I <sub>OH</sub> ≥ -5 mA	VDD-0.8	-	V
V <sub>OL</sub>	Output Low Voltage	I <sub>OL</sub> ≤ 5 mA	-	0.5	V
V <sub>ODH</sub>	Open Drain Output High Voltage	(For all OD pins, and pulled up by external 5 to 9V power supply)	5	9	V
V <sub>ODL</sub>	Open Drain Output Low Voltage	5 mA ≥ I <sub>DOL</sub> ( For all OD pins )	-	0.5	V
I <sub>CC</sub>	Operating Current	Pixel rate=150MHz I <sub>load</sub> = 0uA	-	25	mA
I <sub>SB</sub>	Standby Current	V <sub>in</sub> = VDD, I <sub>load</sub> = 0uA	-	12	mA

## 7.0 SWITCHING CHARACTERISTIC (Under Operating Conditions)

Symbol	Parameter	Min.	Typ.	Max.	Units
f <sub>HFLB</sub>	HFLB input frequency	15	-	150	KHz
f <sub>VFLB</sub>	VFLB input frequency	-	-	200	Hz
T <sub>r</sub>	Output rise time	-	3	-	ns
T <sub>f</sub>	Output fall time	-	3	-	ns
t <sub>BCSU</sub>	SSB to SCK set up time	200	-	-	ns
t <sub>BCH</sub>	SSB to SCK hold time	100	-	-	ns
t <sub>DCSU</sub>	SDA to SCK set up time	200	-	-	ns
t <sub>DCH</sub>	SDA to SCK hold time	100	-	-	ns
t <sub>SCKH</sub>	SCK high time	500	-	-	ns
t <sub>SCKL</sub>	SCK low time	500	-	-	ns
t <sub>SU:STA</sub>	START condition setup time	500	-	-	ns
t <sub>HD:STA</sub>	START condition hold time	500	-	-	ns
t <sub>SU:STO</sub>	STOP condition setup time	500	-	-	ns
t <sub>HD:STO</sub>	STOP condition hold time	500	-	-	ns

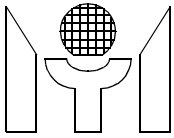

## 8.0 TIMING DIAGRAMS

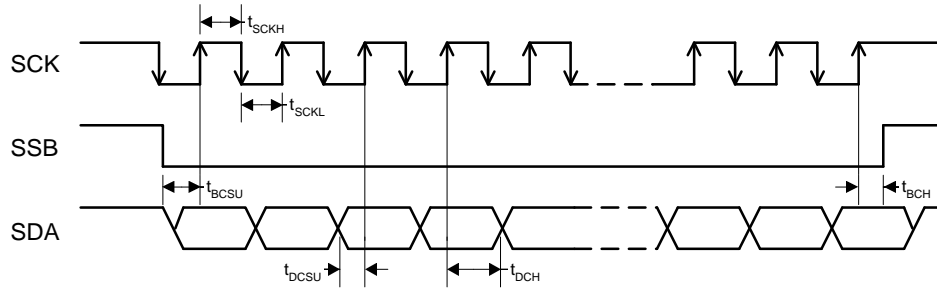

FIGURE 11. Data interface timing(SPI)

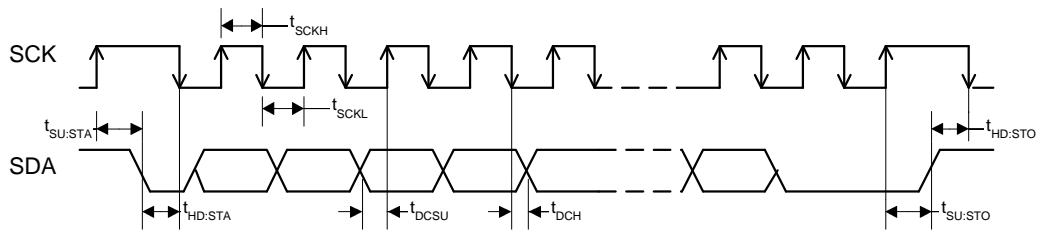
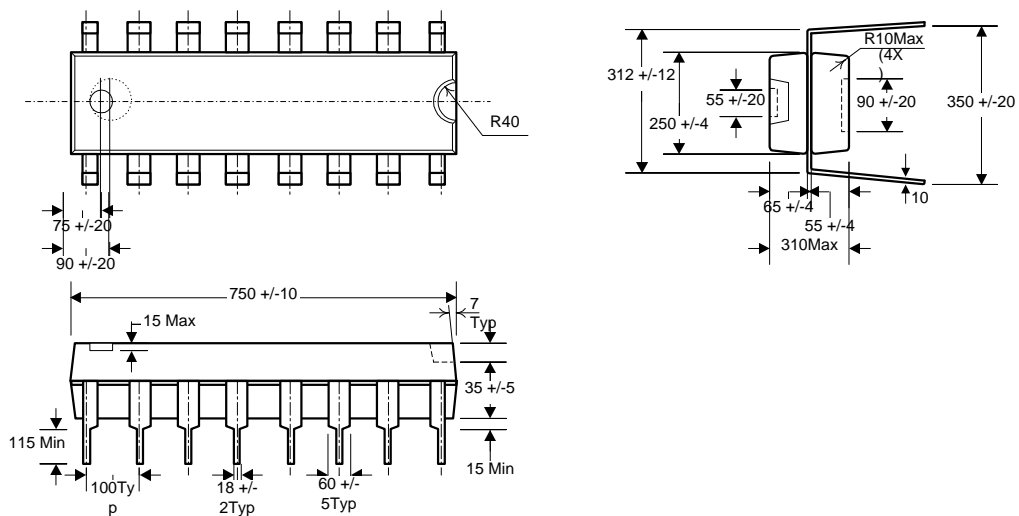
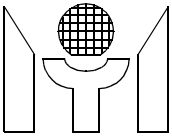

FIGURE 12. Data interface timing(I<sup>2</sup>C)

## 9.0 PACKAGE DIMENSION

### 9.1 16 Pin 300mil





**9.2 20 Pin 300mil**

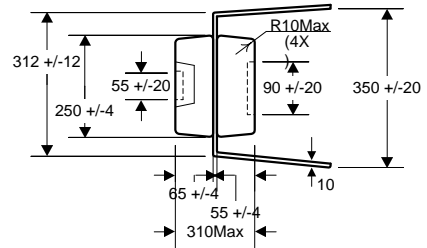
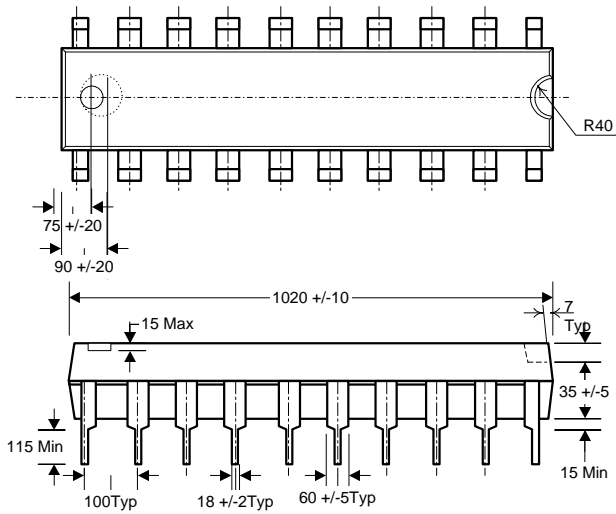

**9.3 24 Pin 300mil**

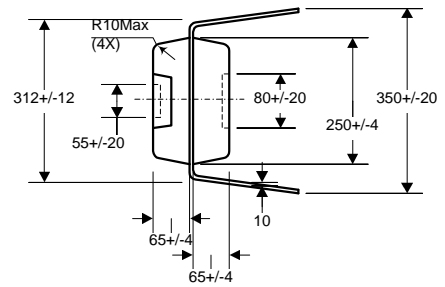
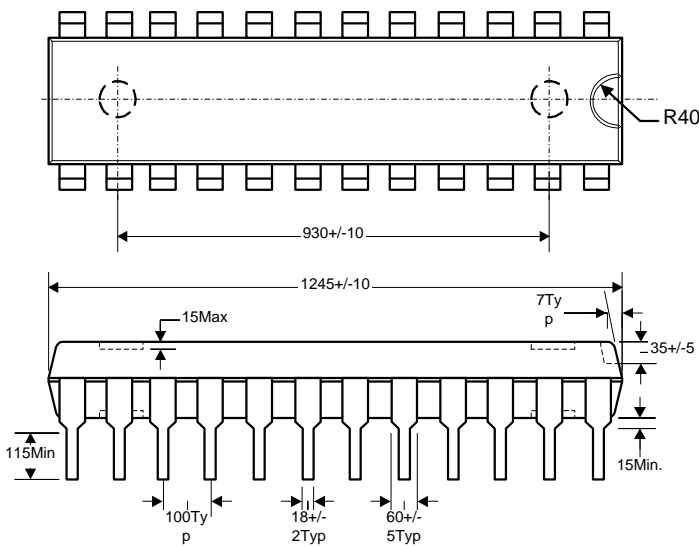

**10.0 CHARACTERS AND SYMBOLS PATTERN**

Please see the attachment.

Myson Technology, Inc. <http://www.myson.com.tw>  
 No. 2, Industry E. Rd. III, Science-Based Industrial Park, Hsinchu, Taiwan, R. O. C.  
 Tel: 886-3-5784866 Fax: 886-3-5785002

Myson Technology USA, Inc. <http://www.myson.com>  
 20111 Stevens Creek Blvd. #138 Cupertino, Ca. 95014, U.S.A.  
 Tel: 408-252-8788 FAX: 408-252-8789 Sales@myson.com