

## VCC4 series

### 1.8, 2.5, 3.3, 5.0 volt CMOS Oscillator

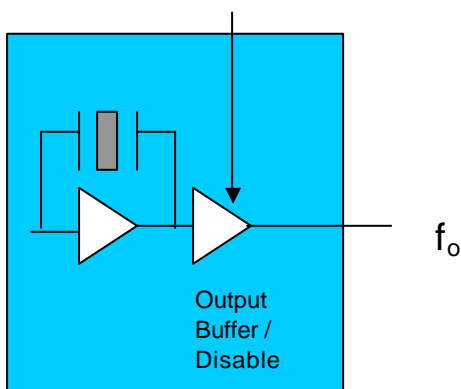

The VCC4 Crystal Oscillator



#### Features

- CMOS output
- Output frequencies to 125 MHz
- Low jitter, Fundamental or 3<sup>rd</sup> OT Crystal
- Tristate output for board test and debug
- -10/70 or -40/85 °C operating temperature
- Gold over nickel contact pads
- Hermetically sealed ceramic SMD package
- Product is compliant to RoHS directive  and fully compatible with lead free assembly

#### Applications

- SONET/SDH/DWDM
- Ethernet, Gigabit Ethernet
- Storage Area Network
- Digital Video
- Broadband Access
- Microprocessors/DSP/FPGA

#### Description

Vectron's VCC4 Crystal Oscillator (XO) is quartz stabilized square wave generator with a CMOS output, operating off either 1.8, 2.5, 3.3 or 5.0 volt supply.

The VCC4 uses fundamental or 3<sup>rd</sup> overtone crystals for output frequencies >50MHz resulting in low jitter performance. Also a monolithic IC, which improves reliability and reduces cost, is hermetically sealed.

## VCC4 Data sheet

### Performance Characteristics

**Table 1. Electrical Performance, 5V option**

Parameter	Symbol	Min	Typical	Maximum	Units
Frequency	$f_o$	1.544		75.000	MHz
Operating Supply Voltage <sup>1</sup>	$V_{DD}$	4.5		5.5	V
Absolute Maximum Supply Voltage		-0.7		7.0	V
Supply Current, Output Enabled < 1.50 MHz 1.500 to 20 MHz 20.01 to 50 MHz 50.01 to 75 MHz	$I_{DD}$			7 10 30 40	mA
Supply Current, Out disabled	$I_{DD}$			30	uA
Output Logic Levels Output Logic High <sup>2</sup> Output Logic Low <sup>2</sup> Output Logic High Drive Output Logic Low Drive	$V_{OH}$ $V_{OL}$ $I_{OH}$ $I_{OL}$	$0.9 \cdot V_{DD}$  16 16		$0.1 \cdot V_{DD}$	V V mA mA
Output Rise/Fall Time <sup>2</sup> < 20.00 MHz 20.01 to 50.00 MHz 50.01 to 75.00 MHz	$t_r/t_f$			8 5 2	ns
Duty Cycle <sup>3</sup> (ordering option)	SYM	45/55			%
Operating temperature (ordering option)		-10/70 or -40/85			°C
Stability <sup>4</sup> (ordering option)		$\pm 25, \pm 50, \pm 100$			ppm
RMS Jitter, 12kHz to 20 MHz			0.5	1	ps
Period Jitter RMS Peak to Peak			3.0 21		ps
Output Enable/Disable <sup>5</sup> Output Enabled Output Disabled		4.0		0.8	V
Internal Enable Pull-Up resistor <sup>5</sup>			100		Kohm
Start-up time				8	ms

1. A 0.01uF and a 0.1uF capacitor should be located as close to the supply as possible (to ground) is recommended.

2. Figure 1 defines these parameters. Figure 2 illustrates the operating conditions under which these parameters are tested and specified.

3. Symmetry is measured defined as On Time/Period.

4. Includes calibration tolerance, operating temperature, supply voltage variations, and shock and vibration (not under operation). 50 and 100ppm options include aging.

5. Output will be enabled if enable/disable is left open.

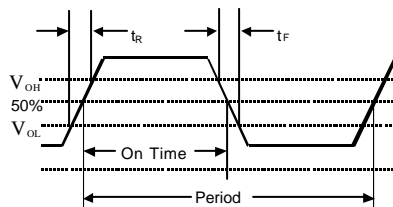

**Figure 1. Output Waveform**

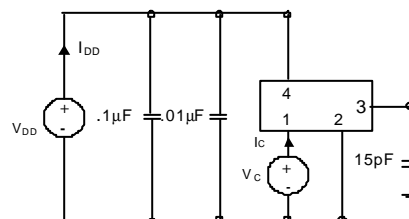

**Figure 2. Typical Output Test Conditions (25±5°C)**

## VCC4 Data sheet

Table 2. Electrical Performance, 3.3V option					
Parameter	Symbol	Min	Typical	Maximum	Units
Frequency	$f_o$	1.544		125.000	MHz
Operating Supply Voltage <sup>1</sup>	$V_{DD}$	2.97	3.3	3.63	V
Absolute Maximum Operating Voltage		-0.5		5.0	V
Supply Current, Output Enabled	$I_{DD}$				mA
< 1.500 MHz				5	
1.5 to 20 MHz				7	
20.01 to 50 MHz				20	
50.01 to 75 MHz				30	
75.01 to 100 MHz				40	
100.01 to 125 MHz				46	
Supply Current, Output disabled	$I_{DD}$			30	uA
Output Logic Levels					
Output Logic High <sup>2</sup>	$V_{OH}$	$0.9 \cdot V_{DD}$			V
Output Logic Low <sup>2</sup>	$V_{OL}$			$0.1 \cdot V_{DD}$	V
Output Logic High Drive	$I_{OH}$	8			mA
Output Logic Low Drive	$I_{OL}$	8			mA
Output Rise/Fall Time <sup>2</sup>	$t_R/t_F$				ns
< 20.00 MHz				10	
20.01 to 50.00 MHz				6	
50.01 to 125.00 MHz				3	
Duty Cycle <sup>3</sup> (ordering option)	SYM		45/55		%
Operating temperature (ordering option)			-10/70 or -40/85		°C
Stability <sup>4</sup> (ordering option)			$\pm 25, \pm 50, \pm 100$		ppm
RMS Jitter, 12kHz to 20 MHz			0.5	1	ps
Period Jitter					ps
RMS			3.0		
Peak to Peak			21		
Output Enable/Disable <sup>5</sup>					V
Output Enabled		2.0			
Output Disabled				0.5	
Internal Enable Pull-Up resistor <sup>5</sup>			100		Kohm
Start-up time				8	ms

1. A 0.01uF and a 0.1uF capacitor should be located as close to the supply as possible (to ground) is recommended.
2. Figure 3 defines these parameters. Figure 4 illustrates the operating conditions under which these parameters are tested and specified. For  $f_o > 90\text{MHz}$ , rise and fall time is measured 20 to 80%.
3. Symmetry is measured defined as On Time/Period.
4. Includes calibration tolerance, operating temperature, supply voltage variations, and shock and vibration (not under operation). 50 and 100ppm options include aging.
5. Output will be enabled if enable/disable is left open.

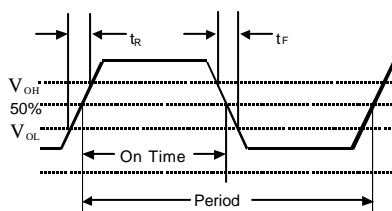

Figure 3. Output Waveform

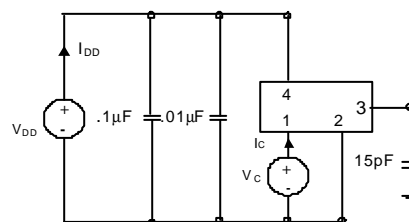

Figure 4. Typical Output Test Conditions ( $25 \pm 5^\circ\text{C}$ )

## VCC4 Data sheet

Table 3. Electrical Performance, 2.5V option					
Parameter	Symbol	Min	Typical	Maximum	Units
Frequency	$f_o$	1.544		125.000	MHz
Operating Supply Voltage <sup>1</sup>	$V_{DD}$	2.25	2.5	2.75	V
Absolute Maximum Voltage		-0.5		5.0	V
Supply Current, Output Enabled < 1.5 MHz 1.500 to 20 MHz 20.01 to 50 MHz 50.01 to 75 MHz 75.01 to 100 MHz 100.01 to 125 MHz	$I_{DD}$			5.0 7.0 15.0 20.0 26.0 36.0	mA
Supply Current, Out disabled	$I_{DD}$			30	uA
Output Logic Levels Output Logic High <sup>2</sup> Output Logic Low <sup>2</sup> Output Logic High Drive Output Logic Low Drive Output Logic High Drive <sup>3</sup> Output Logic Low Drive <sup>3</sup>	$V_{OH}$ $V_{OL}$ $I_{OH}$ $I_{OL}$ $I_{OH}$ $I_{OL}$	$0.9 \cdot V_{DD}$  4 4 8 8		$0.1 \cdot V_{DD}$	V V mA mA mA mA
Output Rise/Fall Time <sup>2</sup> < 20.000 MHz 20.01 to 50.00 MHz 50.01 to 125.00 MHz	$t_R/t_F$			10 6 3	ns
Duty Cycle <sup>4</sup> (ordering option)	SYM		45/55		%
Operating temperature (ordering option)			-10/70 or -40/85		°C
Stability <sup>5</sup> (ordering option)			$\pm 25, \pm 50, \pm 100$		ppm
RMS Jitter, 12kHz to 20 MHz			0.5	1	ps
Period Jitter RMS Peak to Peak			3.0 21		ps
Output Enable/Disable <sup>6</sup> Output Enabled Output Disabled		1.75		0.5	V
Internal Enable Pull-Up resistor <sup>6</sup>			100		Kohm
Start-up time				8	ms

1. A 0.01uF and a 0.1uF capacitor should be located as close to the supply as possible (to ground) is recommended.
2. Figure 5 defines these parameters. Figure 6 illustrates the operating conditions under which these parameters are tested and specified.
3. Overtone designs, output frequencies > 35MHz.
4. Symmetry is measured defined as On Time/Period.
5. Includes calibration tolerance, operating temperature, supply voltage variations, and shock and vibration (not under operation). 50 and 100ppm options include aging.
6. Output will be enabled if enable/disable is left open.

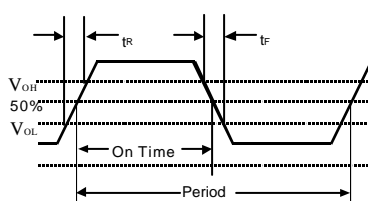

Figure 5. Output Waveform

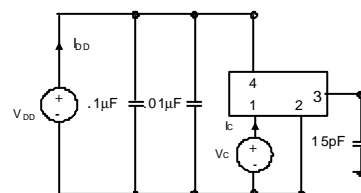

Figure 6. Typical Output Test Conditions (25±5°C)

## VCC4 Data sheet

Table 4. Electrical Performance, 1.8V option					
Parameter	Symbol	Min	Typical	Maximum	Units
Frequency	$f_o$	1.544		75.000	MHz
Operating Supply Voltage <sup>1</sup>	$V_{DD}$	1.71	1.8	1.89	V
Absolute Maximum Voltage		-0.5		3.6	V
Supply Current, Output Enabled < 20 MHz 20.01 to 70 MHz	$I_{DD}$			5 15	mA
Supply Current, Out disabled	$I_{DD}$			30	uA
Output Logic Levels					
Output Logic High <sup>2</sup>	$V_{OH}$	$0.9 \cdot V_{DD}$		$0.1 \cdot V_{DD}$	V
Output Logic Low <sup>2</sup>	$V_{OL}$				V
Output Logic High Drive	$I_{OH}$	2.8			mA
Output Logic Low Drive	$I_{OL}$	2.8			mA
Output Logic High Drive <sup>3</sup>	$I_{OH}$	8			mA
Output Logic Low Drive <sup>3</sup>	$I_{OL}$	8			mA
Output Rise/Fall Time <sup>2</sup> < 20.000 MHz 20.01 to 50.00 MHz 50.01 to 70.00 MHz	$t_R/t_F$			10 6 3	ns
Duty Cycle <sup>4</sup> (ordering option)	SYM		45/55		%
Operating temperature (ordering option)			-10/70 or -40/85		°C
Stability <sup>5</sup> (ordering option)			$\pm 25, \pm 50, \pm 100$		ppm
RMS Jitter, 12kHz to 20 MHz			0.5	1	ps
Period Jitter					ps
RMS			3.0		
Peak to Peak			21		
Output Enable/Disable <sup>6</sup> Output Enabled Output Disabled		1.26		0.5	V
Internal Enable Pull-Up resistor <sup>6</sup>			1		Mohm
Start-up time				8	ms

1. A 0.01uF and a 0.1uF capacitor should be located as close to the supply as possible (to ground) is recommended.

2. Figure 7 defines these parameters. Figure 8 illustrates the operating conditions under which these parameters are tested and specified.

3. Overtone designs, output frequencies > 50MHz.

4. Symmetry is measured defined as On Time/Period.

5. Includes calibration tolerance, operating temperature, supply voltage variations, and shock and vibration (not under operation). 50 and 100 ppm options include aging.

6. Output will be enabled if enable/disable is left open.

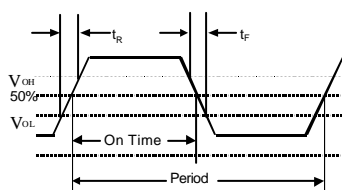

Figure 7. Output Waveform

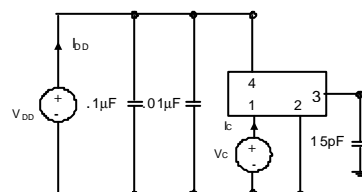

Figure 8. Typical Output Test Conditions (25±5°C)

## VCC4 Data sheet

### Enable/Disable Functional Description

Under normal operation the Enable/Disable is left open, or set to a logic high state, and the VCC4 is oscillating. When the E/D is set to a logic low, the oscillator stops and the output is in a high impedance state. This helps reduce power consumption as well as facilitating board testing and troubleshooting.

### TriState Functional Description

Under normal operation the Tristate is left open or set to a logic high state. When the Tri-State is set to a logic low, the oscillator remains active but the output buffer is in a high impedance state. This helps facilitate board testing and troubleshooting.

### Outline Diagrams, Pad Layout and Pin Out

Pin #	Symbol	Function
1	E/D or NC	Tristate, Enable/Disable or NC
2	GND	Electrical and Case Ground
3	$f_o$	Output Frequency
4	$V_{DD}$	Supply Voltage

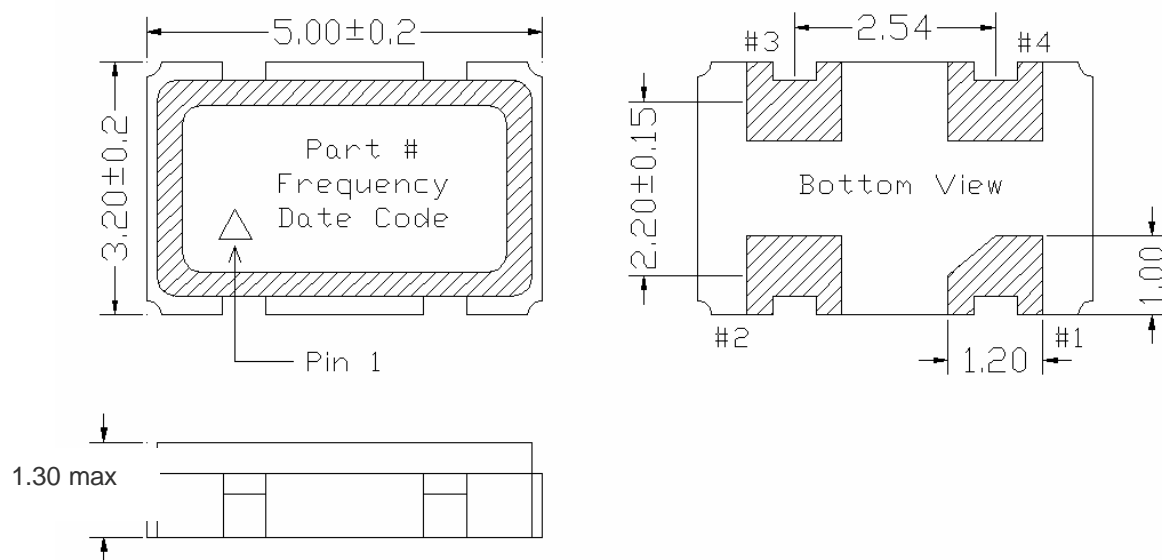

Contact Pads are gold over nickel

**Figure 9, Package drawing**

## VCC4 Data sheet

### Tape and Reel

**Table 6: Tape and Reel Dimensions (mm)**

Tape Dimensions						Reel Dimensions						# Per Reel	
Product	A	B	C	D	E	F	G	H	I	J	K	L	Reel
VCC4	16	7.5	1.5	4	8	2	21	13	60	2	17	180	1000

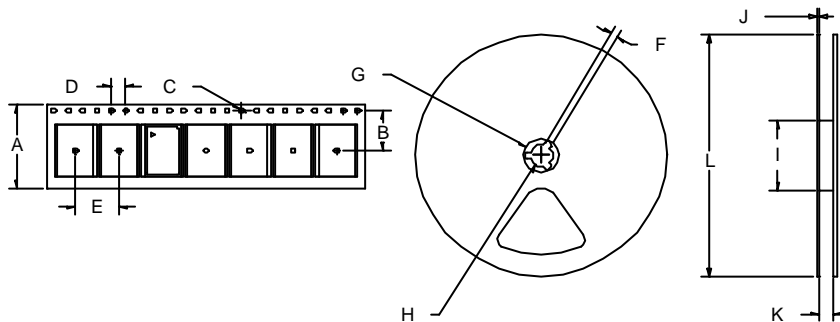

### Absolute Maximum Ratings

Stresses in excess of the absolute maximum ratings can permanently damage the device. Functional operation is not implied at these or any other conditions in excess of conditions represented in the operational sections of this data sheet. Exposure to absolute maximum ratings for extended periods may adversely affect device reliability.

**Table 7. Absolute Maximum Ratings**

Parameter	Symbol	Ratings	Unit
Storage Temperature	T <sub>storage</sub>	-55/125	°C

### Reliability

The VCC4 qualification tests have included:

**Table 8. Environmental Compliance**

Parameter	Conditions
Mechanical Shock	MIL-STD-883 Method 2022
Mechanical Vibration	MIL-STD-883 Method 2007
Temperature Cycle	MIL-STD-883 Method 1010
Solderability	MIL-STD-883 Method 2003
Gross and Fine Leak	MIL-STD-883 Method 1014
Resistance to Solvents	MIL-STD-883 Method 2015

## VCC4 Data Sheet

### Handling Precautions

Although ESD protection circuitry has been designed into the the VCC4, proper precautions should be taken when handling and mounting. VI employs a Human Body Model and a Charged-Device Model (CDM) for ESD susceptibility testing and design protection evaluation. ESD thresholds are dependent on the circuit parameters used to define the model. Although no industry wide standard has been adopted for the CDM, a standard HBM of resistance = 1.5kohms and capacitance = 100pF is widely used and therefore can be used for comparison purposes.

Model	Minimum	Conditions
Human Body Model	1000	MIL-STD-883 Method 3115
Charged Device Model	1500	JESD 22-C101

### Suggested IR profile

Devices are built using lead free epoxy and can also be subjected to standard lead free IR reflow conditions, Table 9 shows max temperatures and lower temperatures can also be used e.g. peak temperature of 220C.

Parameter	Symbol	Value
PreHeat Time	$t_s$	150 sec Min, 200 sec Max
Ramp Up	$R_{UP}$	3 °C/sec Max
Time Above 217 °C	$t_L$	60 sec Min, 150 sec Max
Time To Peak Temperature	$t_{AMB-P}$	480 sec Max
Time At 260 °C (max)	$t_P$	10 sec Max
Time At 240 °C (max)	$t_{p2}$	60 sec Max
Ramp Down	$R_{DN}$	6 °C/sec Max

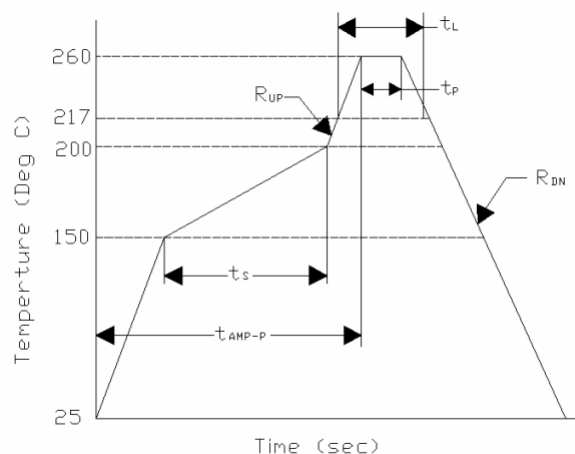



## VCC4 Data Sheet

**Table 11. Standard Frequency List**

9.8304	10.000	11.0596	11.0590	11.2896	12.000	12.272	12.288
12.353	13.000	13.500	13.560	14.318	14.745	16.000	16.376
16.384	16.777216	16.800	17.734	17.734475	18.432	19.440	19.660
19.800	20.000	20.480	22.000	22.5792	24.000	24.5453	24.576
25.000	26.000	27.000	27.120	28.636	28.375	30.000	32.000
32.768	33.000	33.333	34.368	36.000	37.056	37.500	40.000
44.000	44.736	48.000	49.090	50.000	54.000	60.000	66.000
75.000	100.00	106.250	125.000				

## Ordering Information

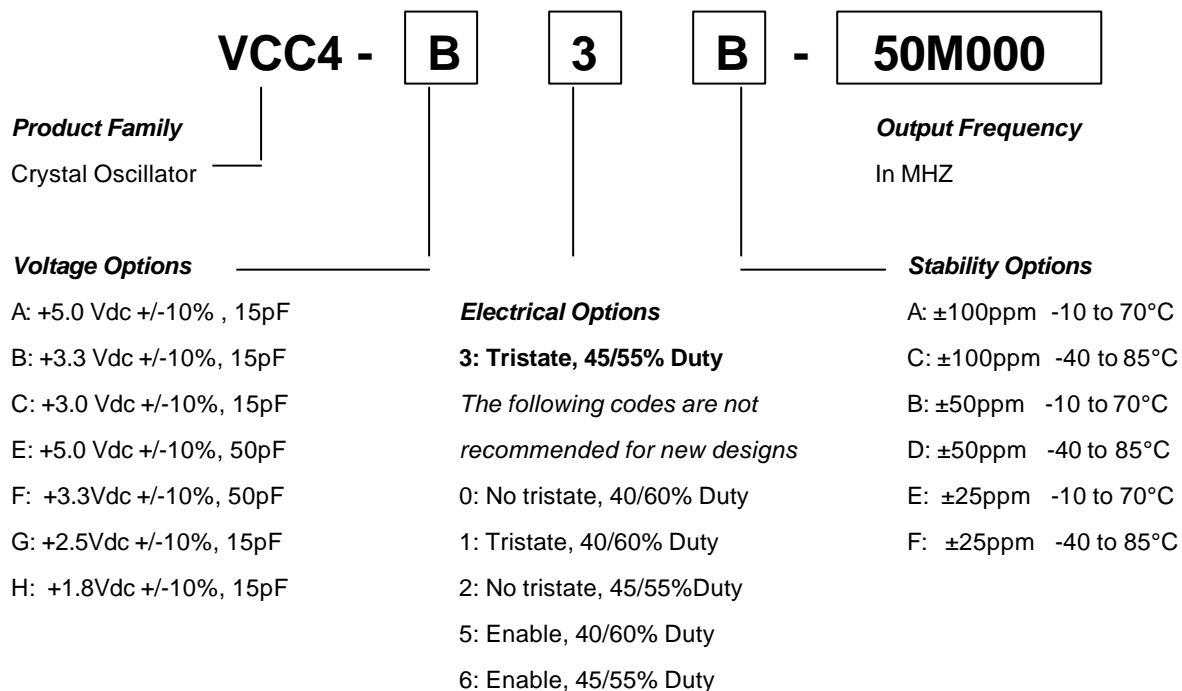

**Note: Not all combinations are available.**

*Tristate with a 45/55% is the most common Electrical code and is recommended for most applications.*

**For Additional Information, Please Contact:**



**USA:** Vectron International • 267 Lowell Road, Hudson, NH 03051  
 • Tel: 1-88-VECTRON-1 • Fax: 1-888-FAX-VECTRON  
**EUROPE:** Landstrasse, D-74924, Neckarbischofsheim, Germany •  
 Tel: 49 (0) 7268 8010 • Fax: 49 (0) 7268 801281  
**ASIA:** Vectron Asia Pacific Sales 1F~2F. No.8 Workshop No.308 Fenju Rd.,  
 WaiGaoQiao Free Trade Zone, Pudong New Area Shanghai, China 200131  
 •Tel: 8621 50480777 • Fax: 8621 50481881

**www.vectron.com**

February 14, 2006

Vectron International 267 Lowell Rd, Hudson NH 03051 Tel: 1-88-VECTRON-1 e-mail vectron@vectron.com