

THREE PHASE CONTROLLED BRIDGE

Power Modules

Features

- Package fully compatible with the industry standard INT-A-pak power modules series
- High thermal conductivity package, electrically insulated case
- Outstanding number of power encapsulated components
- Excellent power volume ratio, outline for easy connections to power transistor modules
- 4000 V_{RMS} isolating voltage

55A
90A
110A

Description

A range of extremely compact, encapsulated three phase controlled bridge rectifiers offering efficient and reliable operation. They are intended for use in general purpose and heavy duty applications.

Major Ratings and Characteristics

Parameters	53MT-K 52MT-K 51MT-K	93MT-K 92MT-K 91MT-K	113MT-K 112MT-K 111MT-K	Units
I_o	55	90	110	A
@ T_C	85	85	85	C
I_{FSM}				
@ 50Hz	390	950	1130	A
@ 60Hz	410	1000	1180	A
I^2t				
@ 50Hz	770	4525	6380	A ² s
@ 60Hz	700	4130	5830	A ² s
V_{RRM} range	800 to 1600			V
T_J	-40 to 125			°C

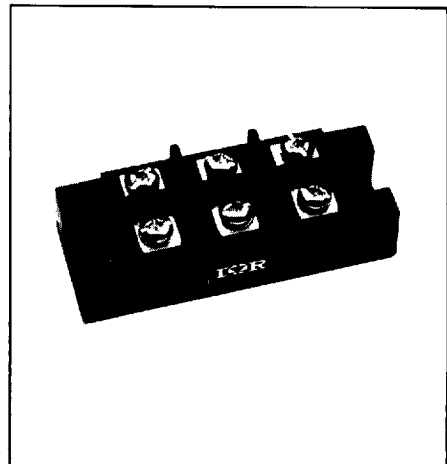

ELECTRICAL SPECIFICATIONS

INTERNATIONAL RECTIFIER

65E D

Voltage Ratings

Type number	Voltage code Code -	V_{RRM} , maximum repetitive peak reverse voltage V	V_{RSM} , maximum non-repetitive peak reverse voltage V	V_{DRM} , max. repetitive peak off-state voltage, gate open circuit V	I_{DRM} 125°C mA
53MT..K (52, 51MT)	80	800	900	800	10
	100	1000	1100	1000	10
	120	1200	1300	1200	10
	140	1400	1500	1400	10
	160	1600	1700	1600	10
93MT..K (92, 91MT)	80	800	900	800	20
	100	1000	1100	1000	20
113MT..K (112, 111MT)	120	1200	1300	1200	20
	140	1400	1500	1400	20
	160	1600	1700	1600	20

On-state Conduction

Parameters	53MT 52MT 51MT	93MT 92MT 91MT	113MT 112MT 111MT	Units	Conditions
I_O Maximum DC output current	55	90	110	A	120°C Rect Conduction angle
	85	85	85	°C	
I_{TSM} Maximum peak one-cycle non-repetitive on-state current Initial $T_J = T_J$ max.	390	950	1130	A	t=10ms No voltage reapplied
	410	1000	1180	A	t=8.3ms $T_J = 125^\circ\text{C}$
	330	800	950	A	t=10ms 100% V_{RRM} reapplied
	345	840	1000	A	t=8.3ms $T_J = 125^\circ\text{C}$
I^2t Maximum I^2t for fusing Initial $T_J = T_J$ max.	770	4525	6380	A ² s	t=10ms No voltage reapplied
	700	4130	5830	A ² s	t=8.3ms $T_J = 125^\circ\text{C}$
	540	3200	4510	A ² s	t=10ms 100% V_{RRM} reapplied
	500	2920	4120	A ² s	t=8.3ms $T_J = 125^\circ\text{C}$
I^2/t Maximum I^2/t for fusing	7700	45250	63800	A ² /s	I^2t for time $t_x = I^2/t_x \sqrt{t_x}$; $0.1 \leq t_x \leq 10\text{ms}$, $V_{RRM} = 0\text{V}$
$V_{F(TO)1}$ Low-level of threshold voltage	1.17	1.09	1.04	V	$T_J = 125^\circ\text{C}$, $(16.7\% \times \pi \times I_{(AV)}) < I < \pi \times I_{(AV)}$
$V_{F(TO)2}$ High-level of threshold voltage	1.45	1.27	1.27	V	$T_J = 125^\circ\text{C}$, $(\pi \times I_{(AV)}) < I < 20 \times \pi \times I_{(AV)}$
r_{t1} Low-level on-state slope resist.	12.40	4.10	3.93	m Ω	$T_J = 125^\circ\text{C}$, $(16.7\% \times \pi \times I_{(AV)}) < I < \pi \times I_{(AV)}$
r_{t2} High-level on-state slope resist.	11.04	3.59	3.37	m Ω	$T_J = 125^\circ\text{C}$, $(\pi \times I_{(AV)}) < I < 20 \times \pi \times I_{(AV)}$
V_{TM} Max. on-state voltage drop	2.68	1.65	1.57	V	$T_J = 25^\circ\text{C}$, $I_{TM} = 150\text{A}_{pk}$ Per single Junction $t_p = 400\mu\text{s}$
di/dt Max. non-repetitive rate of rise of turned on current	150			A/ μs	$T_J = 25^\circ\text{C}$, from $0.67V_{DRM}$ $I_{TM} = \pi \times I_{(AV)}$, $I_g = 500\text{mA}$, $t_r < 0.5\mu\text{s}$, $t_p > 6\mu\text{s}$
I_H Max. holding current	200			mA	$T_J = 25^\circ\text{C}$, anode supply = 6V, resistive load, gate open circuit
I_L Max. latching current	400			mA	$T_J = 25^\circ\text{C}$, anode supply = 6V

Blocking

I_{DRM} Max. peak leakage current	100	μA	$T_J = 25^\circ\text{C}$, per junction at rated V_{RRM}
V_{INS} RMS isolation voltage	4000	V	$T_J = 25^\circ\text{C}$, All terminal shorted $f = 50\text{Hz}$, $t = 1\text{s}$
dv/dt Max. critical rate of rise of off-state voltage	500	V/ μs	$T_J = T_J$ max, linear to 0.67 rated V_{DRM} gate open circuit

* Available with $dv/dt = 1000\text{V}/\mu\text{s}$

Triggering INTERNATIONAL RECTIFIER 65E D

Parameters	53MT	93MT	113MT	Units	Conditions	
	52MT 51MT	92MT 91MT	112MT 111MT			
P _{GM} Maximum peak gate power	8	10	10	W	T _J = T _J max.	
P _{G(AV)} Maximum average gate power	2	2.5	2.5	W	T _J = T _J max	
+I _{GM} Maximum peak gate current	1.5	2.5	2.5	A	T _J = T _J max.	
-V _{GT} Max. peak negative gate volt.	10	10	10	V	T _J = T _J max.	
V _{GT} Maximum required DC gate voltage to trigger	3	4	4	V	T _J = - 40°C	Anode supply = 6V, resistive load
	2	2.5	2.5	V	T _J = 25°C	
	1	1.5	1.5	V	T _J = T _J max.	
I _{GT} Maximum required DC gate current to trigger	90	250	250	mA	T _J = - 40°C	Anode supply = 12V, resistive load
	60	100	100	mA	T _J = 25°C	
	35	50	50	mA	T _J = T _J max	
V _{GD} Maximum gate voltage that will not trigger	0.2	0.25	0.25	V	@ T _J = T _J max., rated V _{DRM} applied	
I _{GD} Maximum gate current that will not trigger	2	6	6	mA	@ T _J = T _J max., rated V _{DRM} applied	

Thermal and Mechanical Specifications

T _J Max. junction temp. range	-40 to 125			°C	
T _{stg} Max. storage temp. range	-40 to 125			°C	
R _{thJC} Max. thermal resistance junction to case	0.179	0.144	0.117	K/W	DC operation per module
	1.074	0.864	0.702	K/W	DC operation per junction
	0.194	0.151	0.123	K/W	120° Rect cond. angle per module
	1.165	0.908	0.739	K/W	120° Rect cond. angle per junction
R _{thCS} Max. thermal resistance, case to heatsink	0.033			K/W	Per module. Mounting surface smooth, flat and greased.
wt Approximate weight	225			g	A mounting compound is recommended and the torque should be rechecked after a period of about 3 hours to allow for the spread of the compound. Lubricated threads.
T Mounting heatsink	4 to 6			Nm	
Torque ± 10% terminal	3 to 4			Nm	

ΔR Conduction (per Junction)

(The following table shows the increment of thermal resistance R_{thJC} when devices operate at different conduction angles than DC)

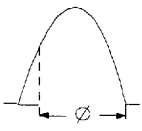
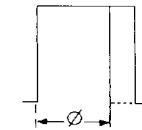
Parameters		53MT	93MT	113MT	Units	Conditions
		52MT 51MT	92MT 91MT	112MT 111MT		
	180°	0.072	0.033	0.027	K/W	T _J = T _J max.
	120°	0.085	0.039	0.033	K/W	
	90°	0.108	0.051	0.042	K/W	
	60°	0.152	0.069	0.057	K/W	
	30°	0.233	0.099	0.081	K/W	
	180°	0.055	0.027	0.023	K/W	T _J = T _J max
	120°	0.091	0.044	0.037	K/W	
	90°	0.117	0.055	0.046	K/W	
	60°	0.157	0.071	0.059	K/W	
	30°	0.236	0.100	0.082	K/W	

Ordering Information Table

INTERNATIONAL RECTIFIER

65E D



- 1** - Current rating code:
 - 3 MT = three phase controlled bridge
 - 2 MT = positive three phase controlled bridge
 - 1 MT = negative three phase controlled bridge
- 2** - Basic part number
- 3** - Voltage code (code x 10 = V_{RRM})

53 (52, 51)	= 55 A (Avg)
93 (92, 91)	= 90 A (Avg)
113 (112, 111)	= 110 A (Avg)

Outline Table

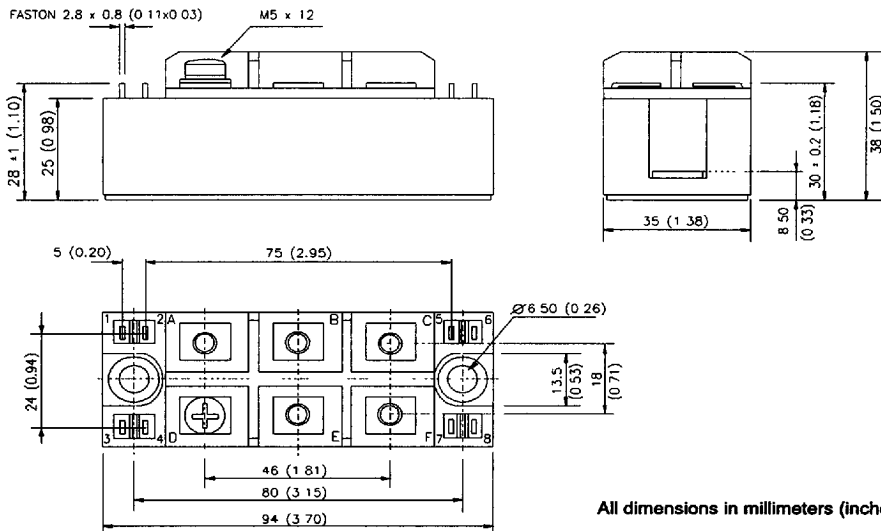

All dimensions in millimeters (inches)

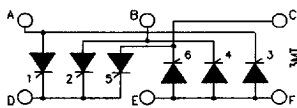

three phase controlled bridge
(53, 93, 113MT..K)

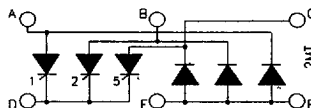

positive three phase controlled bridge
(52, 92, 112MT..K)

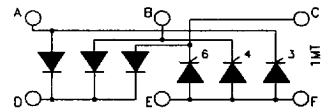

negative three phase controlled bridge
(51, 91, 111MT..K)

INTERNATIONAL RECTIFIER

6SE D

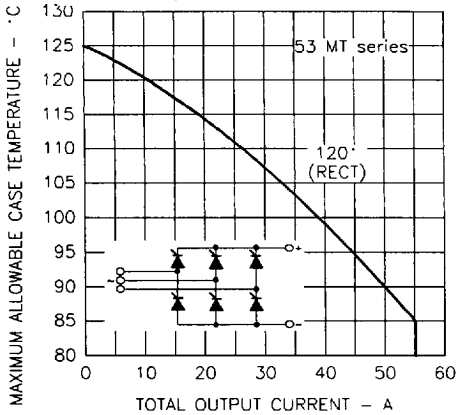

Fig. 1 - Current Ratings Characteristics

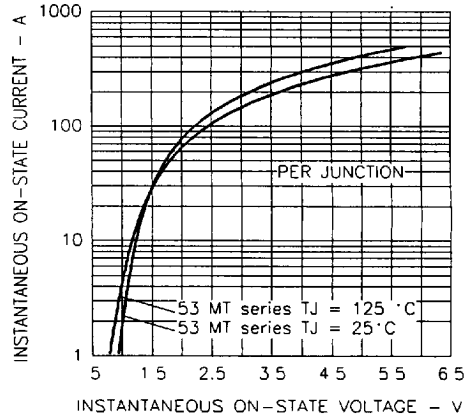

Fig. 2 - Forward Voltage Drop Characteristics

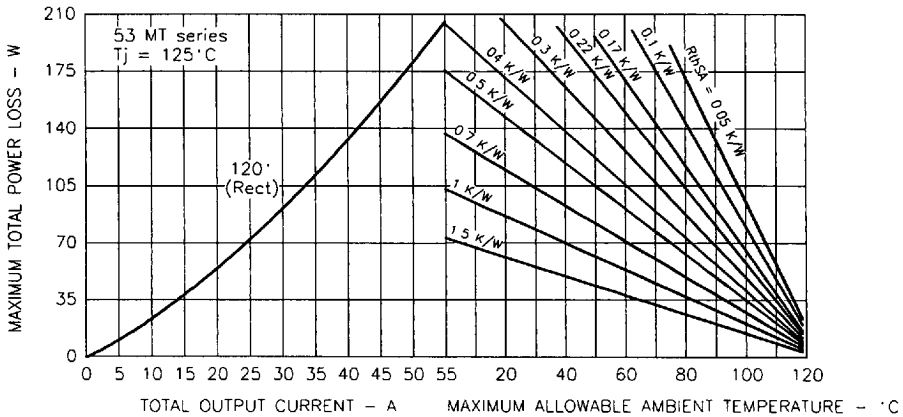

Fig. 3 - Total Power Loss Characteristics

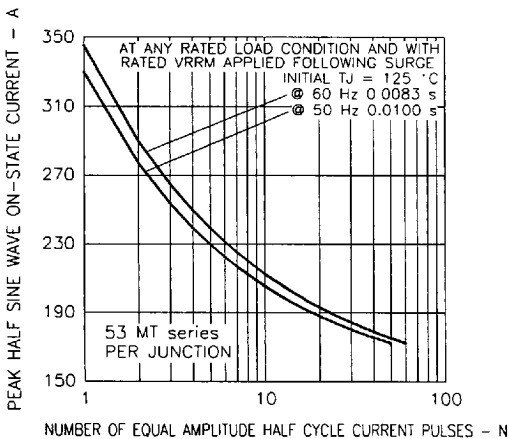

Fig. 4 - Maximum Non-Repetitive Surge Current

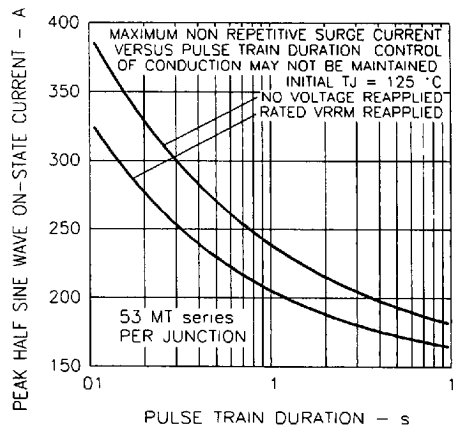

Fig. 5 - Maximum Non-Repetitive Surge Current

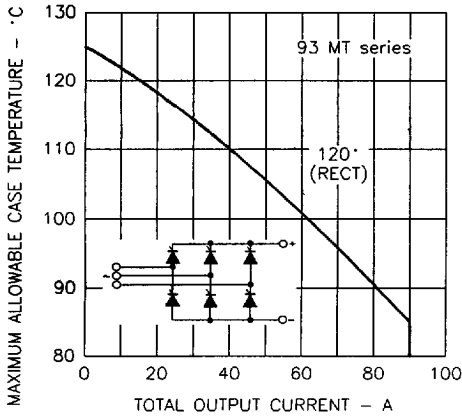

Fig. 6 - Current Ratings Characteristics

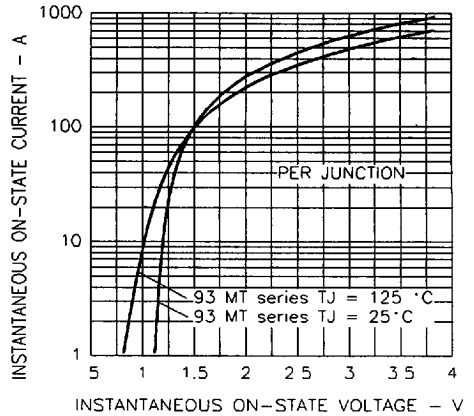

Fig. 7 - Forward Voltage Drop Characteristics

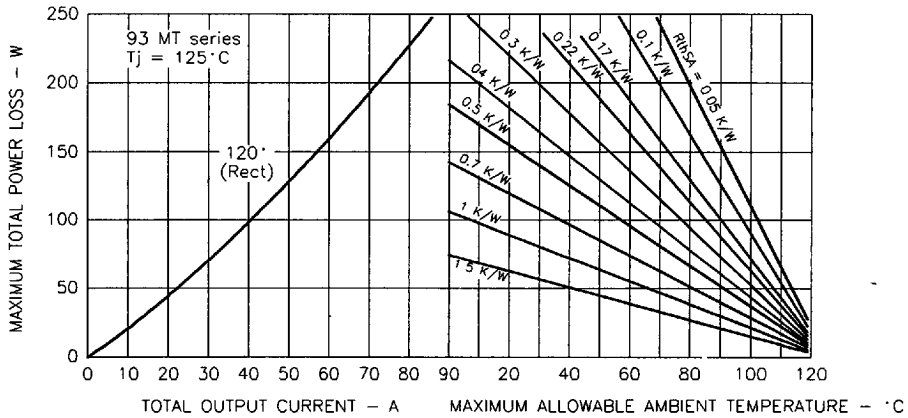

Fig. 8 - Total Power Loss Characteristics

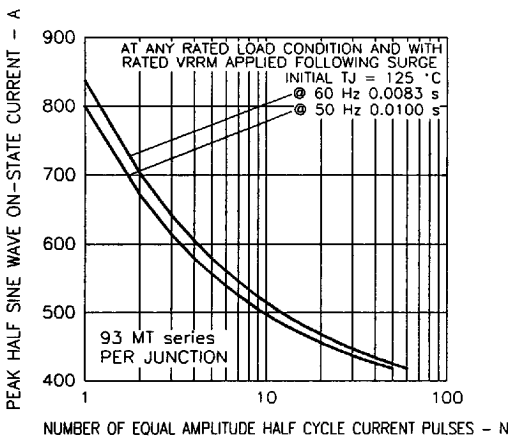

Fig. 9 - Maximum Non-Repetitive Surge Current

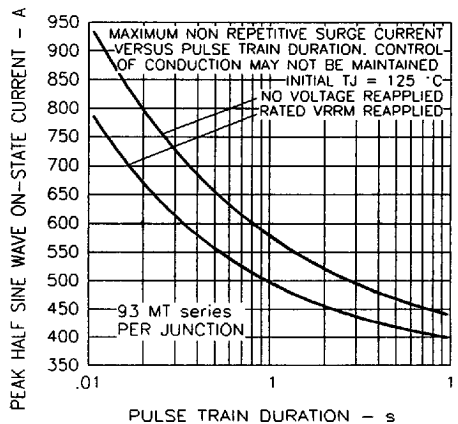

Fig. 10 - Maximum Non-Repetitive Surge Current

INTERNATIONAL RECTIFIER

6SE D

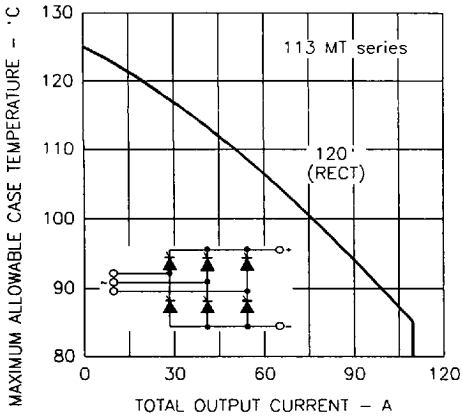

Fig. 11 - Current Ratings Characteristics

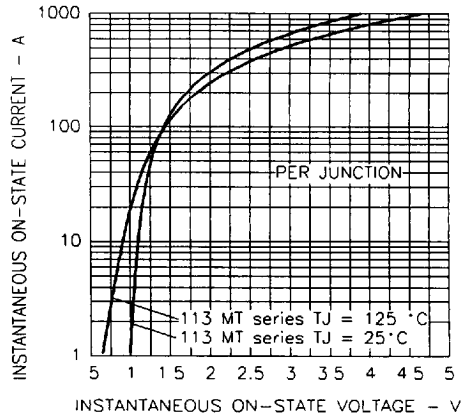

Fig. 12 - Forward Voltage Drop Characteristics

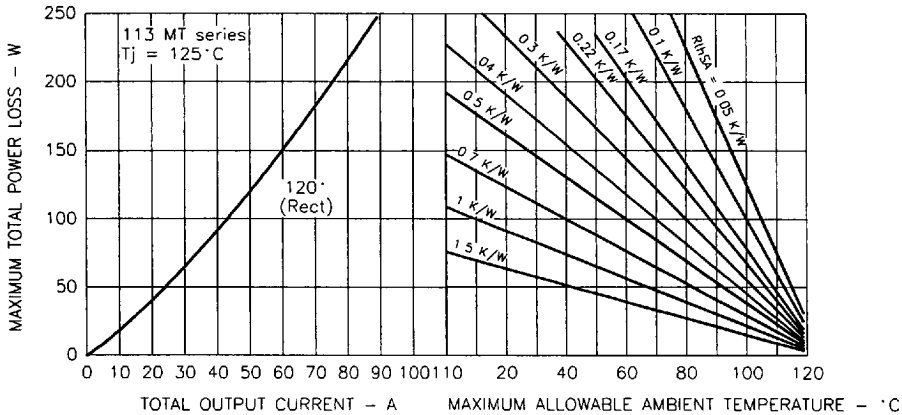

Fig. 13 - Total Power Loss Characteristics

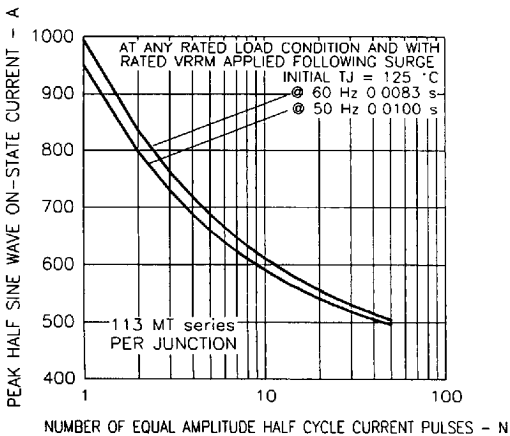

Fig. 14 - Maximum Non-Repetitive Surge Current

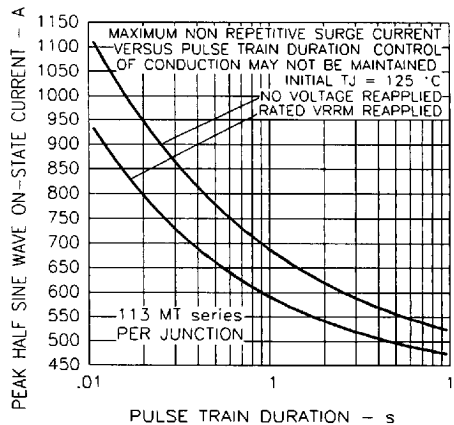

Fig. 15 - Maximum Non-Repetitive Surge Current

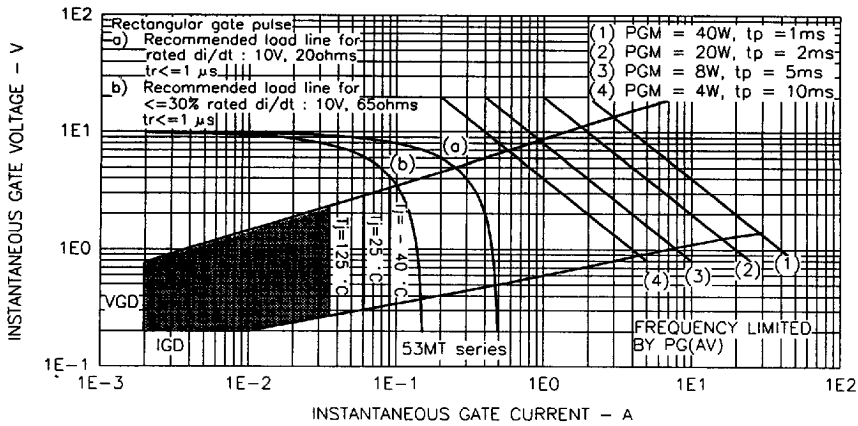

Fig. 17 - Gate Characteristics

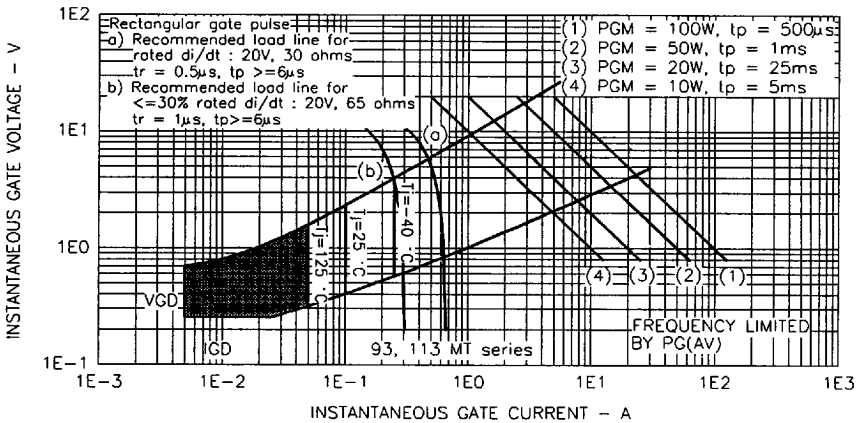

Fig. 18 - Gate Characteristics

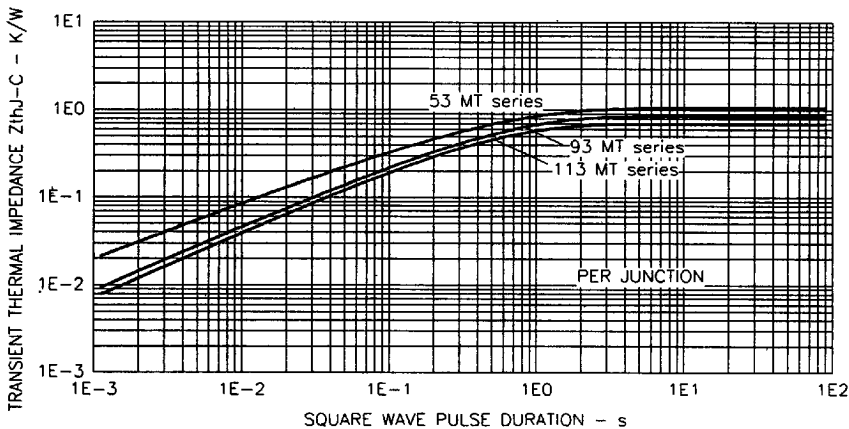

Fig. 19 - Thermal Impedance Z_{thJC} Characteristics