

"High Frequency Ceramic Solutions"

400 MHz EMI Filter Array

P/N 0400FA15A0400

Detail Specification: 11/05/08

Page 1 of 2

General Specifications

Part Number	0400FA15A0400
Cut Off Frequency (Mhz)	400
Capacitance (+30/-30%) (pF)	18
20 dB min. Attenuation (Mhz)	800 - 1000
Rated Current (mA)	50
Rated Voltage (VDC)	25

Power Capacity	0.5 W max.
Reel Quantity	4,000
Operating Temperature	-40 to +85°C
Storage Temperature	+5 to +35°C, Humidity: 45-75%RH, 12 mos. Max*

* 12 months in vacuum sealed bag and 1 week after opened.

P/N Suffix	Packaging Style	Bulk	Suffix = S	Eg. 0400FA15A0400S
		T & R	Suffix = E	Eg. 0400FA15A0400E
	Termination Style	100% Tin	Suffix = None	Eg. 0400FA15A0400(E or S)
		Tin / Lead	Suffix = /Pb	Eg. 0400FA15A0400(E or S)/Pb

Mechanical Dimensions

	In	mm
L	0.079 ± 0.008	2.00 ± 0.20
W	0.049 ± 0.008	1.25 ± 0.20
T	0.028 ± 0.006	0.70 ± 0.15
a	0.010 ± 0.004	0.25 ± 0.10
b	0.012 ± 0.006	0.30 ± 0.15
c	0.008 +.004/-0.006	0.20 +0.1/-0.15
p	0.020 ± 0.004	0.50 ± 0.10

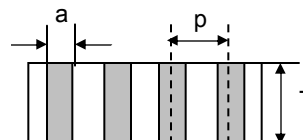
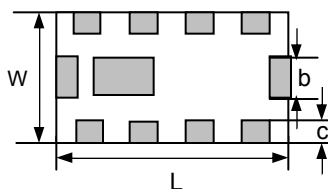





Mounting Considerations

Mount these devices with brown mark facing up.

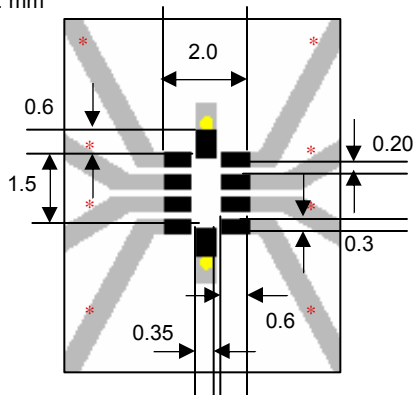
Line width should be designed to provide 50Ω impedance matching characteristics.

Units: mm



-  Solder Resist
-  Land
-  Through-hole (ϕ 0.25)

Terminal Configuration

No.	Function
1	IN1
2	IN2
3	IN3
4	IN4
5	GND
6	OUT4
7	OUT3
8	OUT2
9	OUT1
10	GND

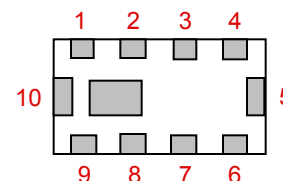

Johanson Technology, Inc. reserves the right to make design changes without notice.

All sales are subject to Johanson Technology, Inc. terms and conditions.



www.johansontechology.com

4001 Calle Tecate • Camarillo, CA 93012 • TEL 805.389.1166 FAX 805.389.1821

2008 Johanson Technology, Inc. All Rights Reserved

"High Frequency Ceramic Solutions"

400 MHz EMI Filter Array

P/N 0400FA15A0400

Detail Specification: 11/05/08

Page 2 of 2

Typical Electrical Performance (T=25°C)

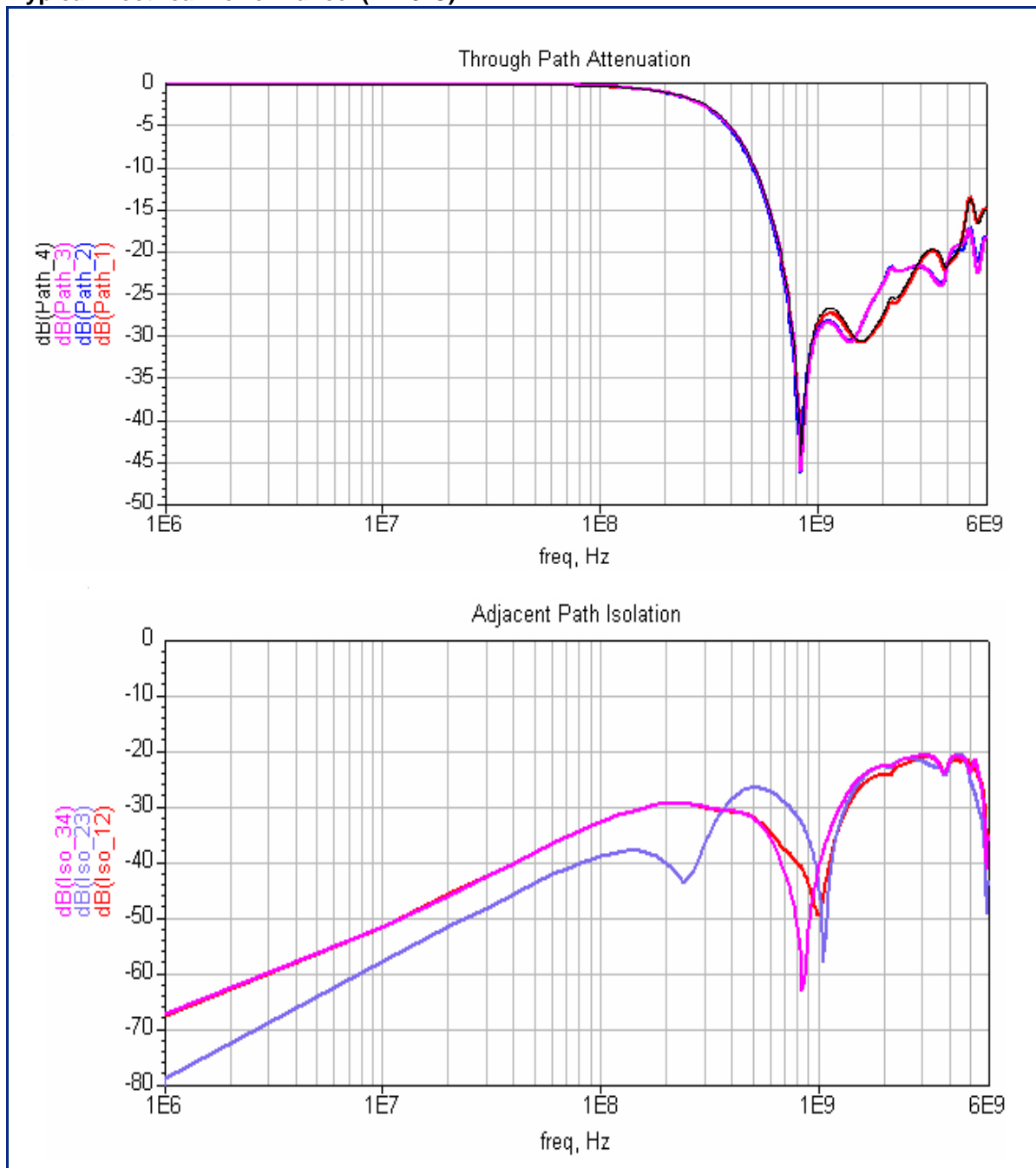

Johanson Technology, Inc. reserves the right to make design changes without notice.

All sales are subject to Johanson Technology, Inc. terms and conditions.



www.johansontechnology.com

4001 Calle Tecate • Camarillo, CA 93012 • TEL 805.389.1166 FAX 805.389.1821

2008 Johanson Technology, Inc. All Rights Reserved