

SAMSUNG

ELECTRONICS

Preliminary



TO :
DATE : Dec.5, 2008.

SAMSUNG TFT-LCD

MODEL NO. : LTN140AT01-G01

NOTE : Extension code [-0]
→ LTN140AT01-G01
Surface type [**Glare**]

The information described in this SPEC is preliminary and can be changed without prior notice.

APPROVED BY :

Handwritten signature in black ink.

PREPARED BY :

Handwritten signature in black ink.

LCD DEVELOPMENT G1. MOBILE DIVISION
SAMSUNG ELECTRONICS CO., LTD.

Samsung Secret

Doc.No.	LTN140AT01-G01	Rev.No	04-P05-G-081007	Page	1 / 30
----------------	----------------	---------------	-----------------	-------------	--------

CONTENTS

Revision History	----- (3)
General Description	----- (4)
1. Absolute Maximum Ratings	----- (5)
1.1 Absolute Ratings of environment	
1.2 Electrical Absolute Ratings	
2. Optical Characteristics	----- (7)
3. Electrical Characteristics	----- (10)
3.1 TFT LCD Module	
3.2 Backlight Unit	
3.3 LED Driver	
4. Block Diagram	----- (13)
4.1 TFT LCD Module	
4.2 LED Placement Structure	
5. Input Terminal Pin Assignment	----- (14)
5.1 Input Signal & Power	
5.2 LVDS Interface	
5.3 Timing Diagrams of LVDS For Transmitting	
5.4 Input Signals, Basic Display Colors and Gray Scale of Each Color.	
5.5 Pixel format	
6. Interface Timing	
6.1 Timing Parameters	----- (19)
6.2 Timing Diagrams of interface Signal	
6.3 Power ON/OFF Sequence	
7. Outline Dimension	----- (21)
8. Packing	----- (23)
9. Markings & Others	----- (24)
10. General Precaution	----- (26)
11. EDID	----- (28)

Samsung Secret

GENERAL DESCRIPTION

DESCRIPTION

LTN140AT01-G01 is a color active matrix TFT (Thin Film Transistor) liquid crystal display (LCD) that uses amorphous silicon TFT as switching devices. This model is composed of a TFT LCD panel, a driver circuit and a backlight system. The resolution of a 14.0" contains 1366 x 768 pixels and can display up to 262,144 colors. 6 O'clock direction is the Optimum viewing angle.

FEATURES

- High contrast ratio, high aperture structure
- 1366 x 768 pixels resolution
- Fast Response Time
- Low power consumption
- LED BLU Structure
- DE (Data enable) only mode.
- 3.3V LVDS Interface
- On board EDID chip
- RoHS Compliance

APPLICATIONS

- Notebook PC
- If the usage of this product is not for PC application, but for others, please contact SEC

GENERAL INFORMATION

Item	Specification	Unit	Note
Display area	309.399(H) X 173.952(V) (14.0"diagonal)	mm	
Driver element	a-si TFT active matrix		
Display colors	262,144		
Number of pixel	1366 x 768	pixel	16 : 9
Pixel arrangement	RGB vertical stripe		
Pixel pitch	0.2265(H) x 0.2265(V)	mm	
Display Mode	Normally white		
Glass Thickness	0.5T		
Surface treatment	Haze 0, Hard-Coating 3H		

Samsung Secret

Doc.No.	LTN140AT01-G01	Rev.No	04-P05-G-081007	Page	3 / 30
----------------	----------------	---------------	-----------------	-------------	--------

Mechanical Information

Item		Min.	Typ.	Max.	Unit	Note
Module size	Horizontal (H)	(323.0)	(323.5)	(324.0)	mm	
	Vertical (V)	(191.5)	(192.0)	(192.5)	mm	
	Depth (D)	-		(5.2)	mm	(1)
Weight		-		(350)	g	

Note (1) Measurement condition of outline dimension
 . Equipment : Vernier Calipers
 . Push Force : 500g · f (minimum)

1. ABSOLUTE MAXIMUM RATINGS

1.1 ENVIRONMENTAL ABSOLUTE RATINGS

Item	Symbol	Min.	Max.	Unit	Note
Storage temperate	TSTG	-20	60	°C	(1)
Operating temperate (Temperature of glass surface)	TOPR	0	50	°C	(1)
Shock (non-operating)	Snop	-	240	G	(2),(4)
Vibration (non-operating)	Vnop	-	2.41	G	(3),(4)

Note (1) Temperature and relative humidity range are shown in the figure below.
 95 % RH Max. ($40\text{ }^{\circ}\text{C} \geq T_a$)
 Maximum wet - bulb temperature at $39\text{ }^{\circ}\text{C}$ or less. ($T_a > 40\text{ }^{\circ}\text{C}$) No condensation

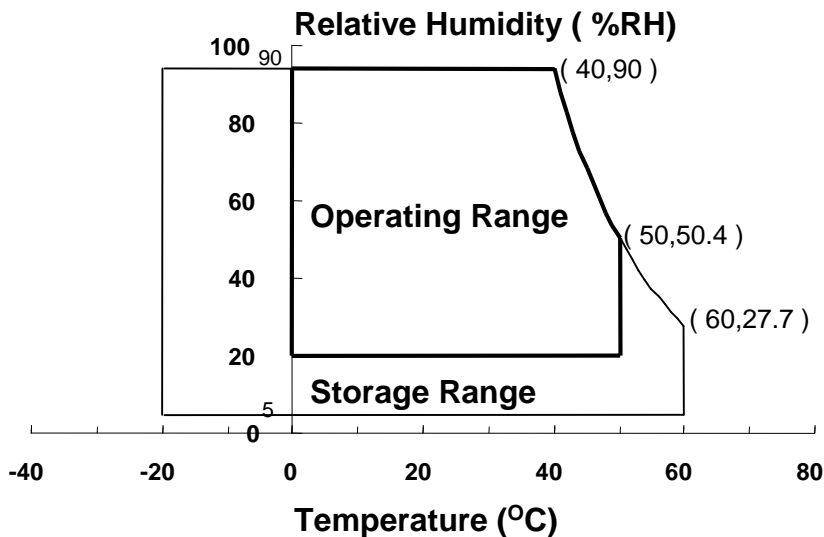

- (2) 2ms, half sine wave, one time for $\pm X, \pm Y, \pm Z$.
- (3) 5 - 500 Hz, random vibration, 30min for X, Y, Z.
- (4) At testing Vibration and Shock, the fixture in holding the Module to be tested have to be hard and rigid enough so that the Module would not be twisted or bent by the fixture.

Samsung Secret

1.2 ELECTRICAL ABSOLUTE RATINGS

(1) TFT LCD MODULE

 $V_{DD} = 3.3V, V_{SS} = GND = 0V$

Item	Symbol	Min.	Max.	Unit	Note
Power Supply Voltage	V_{DD}	$V_{DD} - 0.3$	$V_{DD} + 0.3$	V	(1)
Logic Input Voltage	V_{DD}	$V_{DD} - 0.3$	$V_{DD} + 0.3$	V	(1)

Note (1) Within T_a ($25 \pm 2 \text{ }^\circ\text{C}$)

(2) BACK-LIGHT UNIT

 $T_a = 25 \pm 2 \text{ }^\circ\text{C}$

Item	Symbol	Min.	Typ.	Max.	Unit	Note
LED Current	I_L	-	20	-	mA	(1)
LED Voltage	F_L	-	3.2	-	V	(1)

Note 1) Permanent damage to the device may occur if maximum values are exceeded
Functional operation should be restricted to the conditions described under normal operating conditions.

Samsung Secret

2. OPTICAL CHARACTERISTICS

The following items are measured under stable conditions. The optical characteristics should be measured in a dark room or equivalent state with the methods shown in Note (5).
 Measuring equipment : TOPCON BM-5A and PR-650

* Ta = 25 ± 2 °C, V_{DD}=3.3V, f_v= 60Hz, f_{DCLK} = TBDMHz, I_L = TBD mA

Item	Symbol	Condition	Min.	Typ.	Max	Unit	Note	
Contrast Ratio (5 Points)	CR	Normal Viewing Angle φ = 0 θ = 0	(400)	(500)	-	-	(1), (2), (5)	
Response Time at Ta (Rising + Falling)	T _{RT}		-	(8)	(12)	msec	(1), (3)	
Average Luminance of White (5 Points)	Y _{L,AVE}		(190)	(220)	-	cd/m ²	(1), (4)	
Color Chromaticity (CIE)	Red		R _X	(0.530)	(0.560)	(0.590)	-	(1), (5) PR-650
			R _Y	(0.300)	(0.330)	(0.360)		
	Green		G _X	(0.305)	(0.335)	(0.365)		
			G _Y	(0.515)	(0.545)	(0.575)		
	Blue		B _X	(0.125)	(0.155)	(0.185)		
			B _Y	(0.070)	(0.100)	(0.130)		
	White		W _X	(0.283)	(0.313)	(0.343)		
		W _Y	(0.299)	(0.329)	(0.359)			
Viewing Angle	Hor.	θ _L	(40)	(45)	-	Degrees	(1), (5) BM-5A	
		θ _H	(40)	(45)	-			
	Ver.	φ _H	(10)	(15)	-			
		φ _L	(25)	(30)	-			
Color Gamut	CG		42	45	-	%		
13 Points White Variation	δ _L		-	-	(1.7)	-	(6)	

Samsung Secret

Note 1) Definition of Viewing Angle : Viewing angle range($10 \leq C/R$)

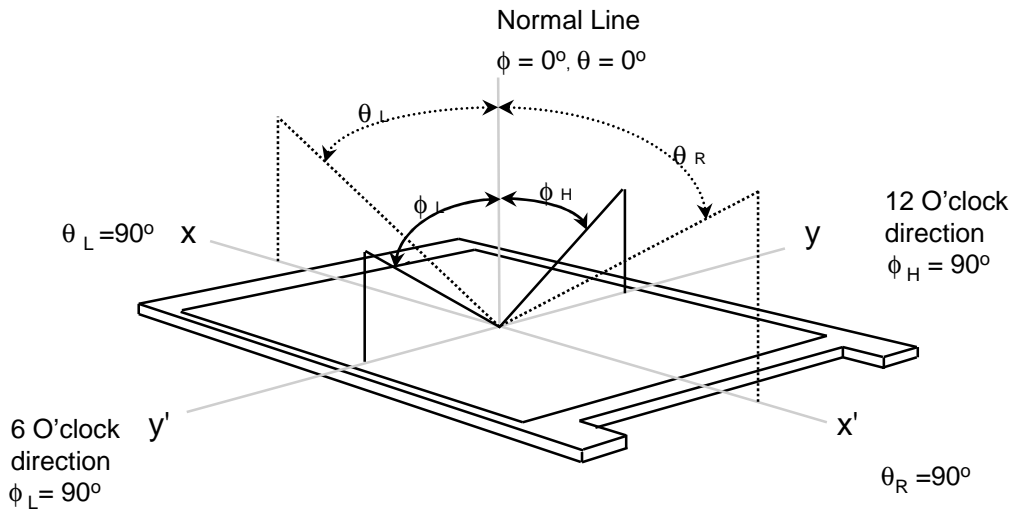

Note 2) Definition of Contrast Ratio (CR) : Ratio of gray max (Gmax) ,gray min (Gmin) at 5 points(4, 5, 7, 9, 10)

$$CR = \frac{CR(4) + CR(5) + CR(7) + CR(9) + CR(10)}{5}$$

Points : (4) , (5) , (7) , (9) , (10) at the figure of Note (6).

Note 3) Definition of Response time :

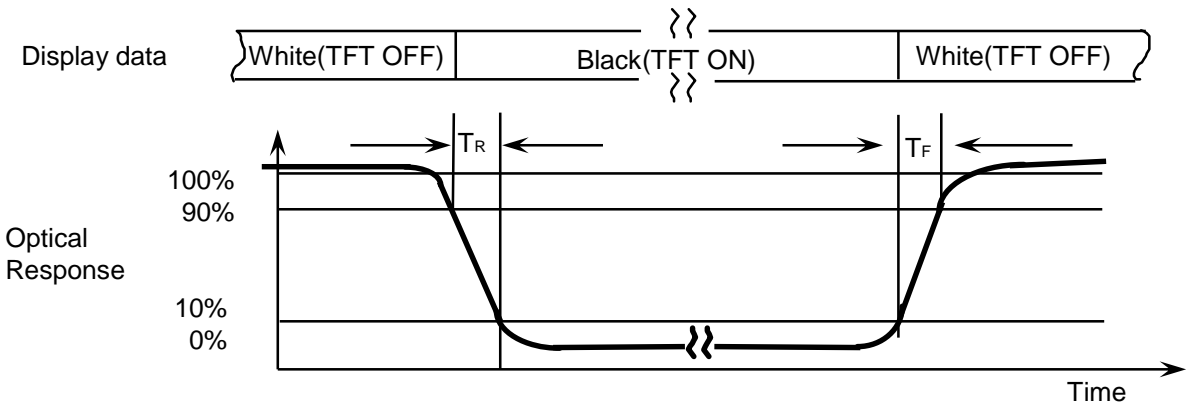

Note 4) Definition of Average Luminance of White : measure the luminance of white at 5 points.

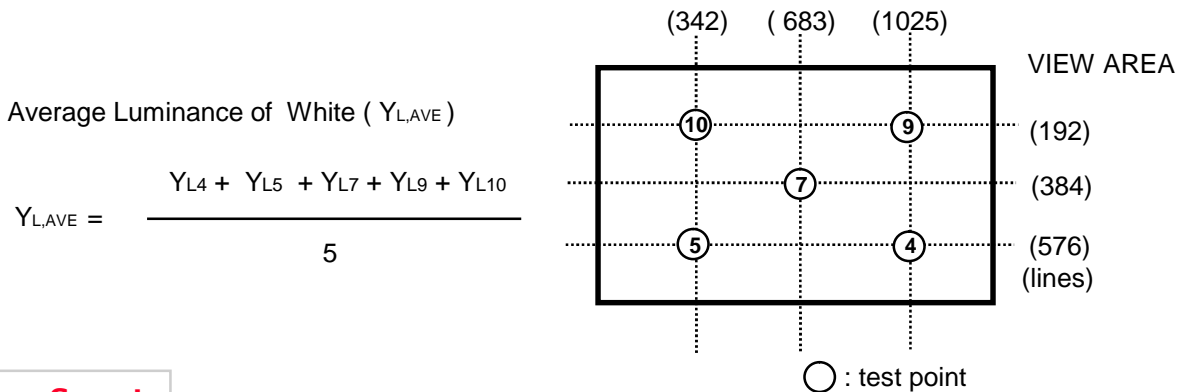

Note 5) After stabilizing and leaving the panel alone at a given temperature for 30 min , the measurement should be executed. Measurement should be executed in a stable, windless, and dark room. 30 min after lighting the backlight. This should be measured in the center of screen.
 Lamp current : 6.0mA (Inverter : SIC-130T)
 Environment condition : $T_a = 25 \pm 2 \text{ }^\circ\text{C}$

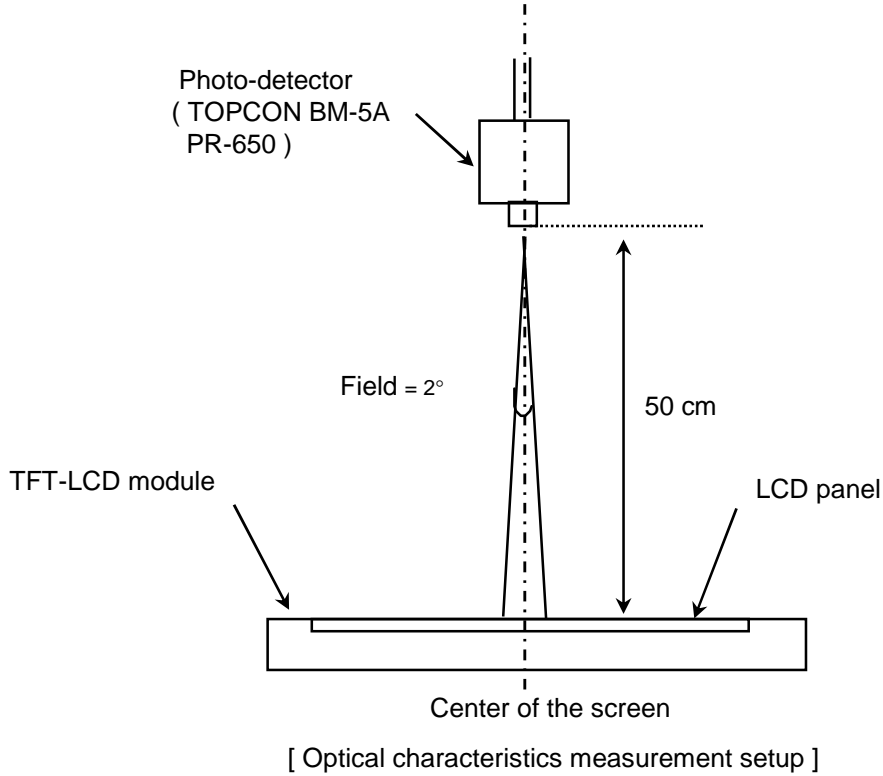

Note 6) Definition of 13 points white variation (δL), [① ~ ⑬]

$$\delta L = \frac{\text{Maximum luminance of 13 points}}{\text{Minimum luminance of 13 points}}$$

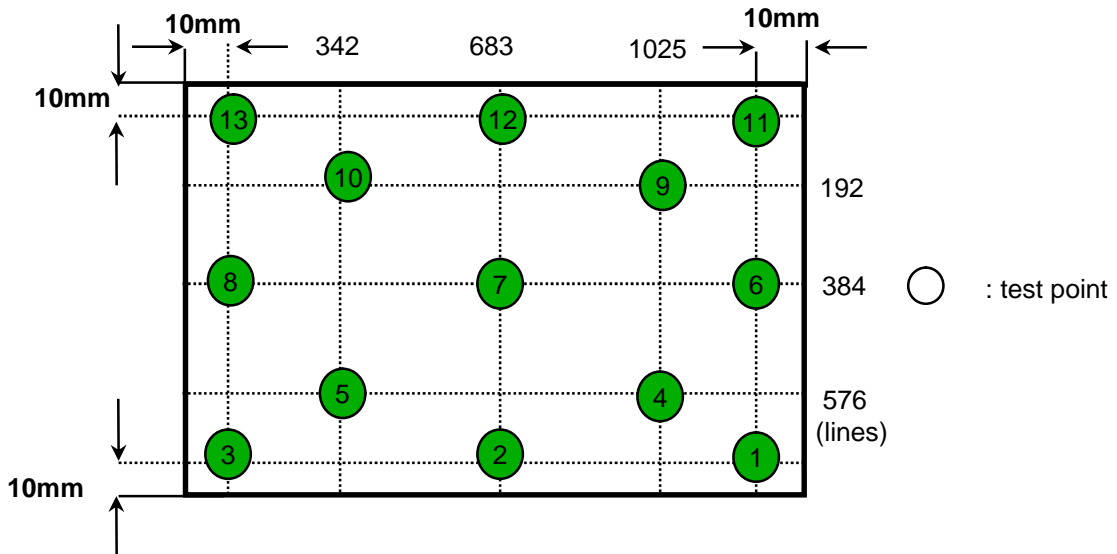

Samsung Secret

3. ELECTRICAL CHARACTERISTICS

3.1 TFT LCD MODULE

Ta= 25 ± 2°C

Item	Symbol	Min.	Typ.	Max.	Unit	Note	
Voltage of Power Supply	V _{DD}	(3.0)	(3.3)	(3.6)	V		
Differential Input Voltage for LVDS Receiver Threshold	High	V _{IH}	-	-	(+100)	mV	V _{CM} = +1.2V
	Low	V _{IL}	(-100)	-	-	mV	
Vsync Frequency	f _V	-	60	-	Hz		
Hsync Frequency	f _H	-	47.4	-	KHz	Vsync=60Hz	
Main Frequency	f _{DCLK}	-	72.33	-	MHz		
Rush Current	I _{RUSH}	-	-	(1.5)	A	(4)	
Current of Power Supply	White	I _{DD}	-	300	-	mA	(2),(3)*a
	Mosaic		-	350	-	mA	(2),(3)*b
	V. Stripe		-	450	485	mA	(2),(3)*c

Note (1) Display data pins and timing signal pins should be connected.(GND = 0V)

(2) f_V = 60Hz, f_{DCLK} = 72.33MHz, V_{DD} = 3.3V , DC Current.

(3) Power dissipation pattern

*a) White Pattern

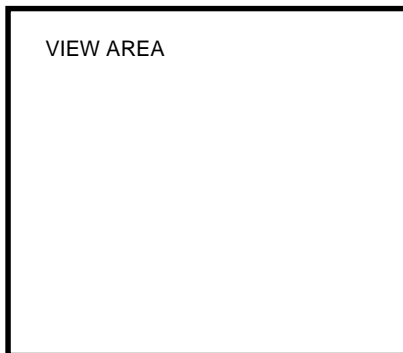

*b) Mosaic Pattern

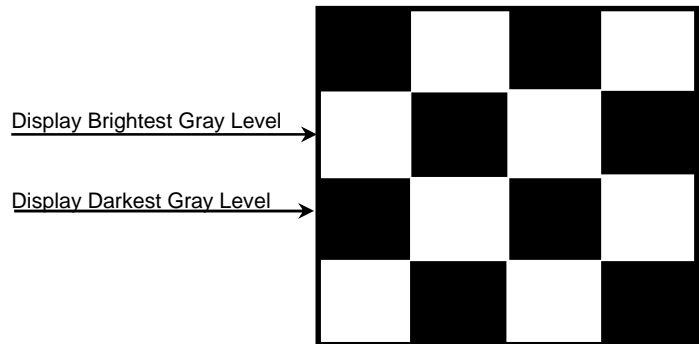

Samsung Secret

*c) 1dot Vertical stripe pattern

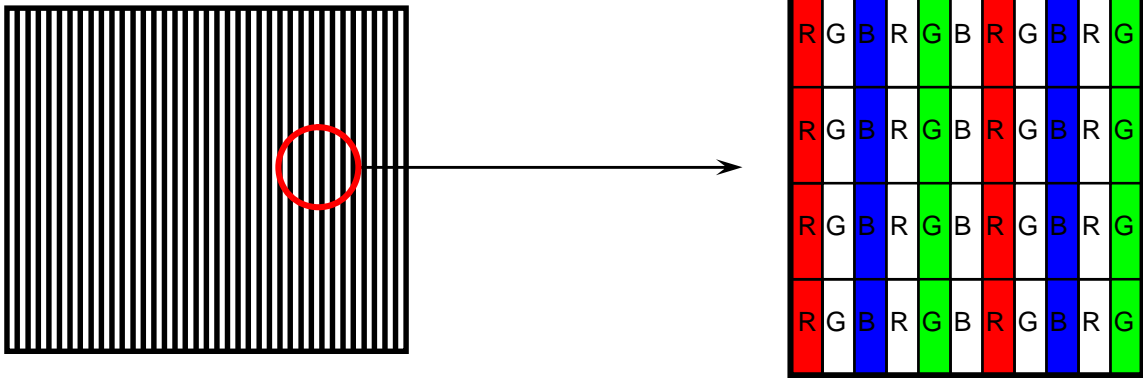

4) Rush current measurement condition

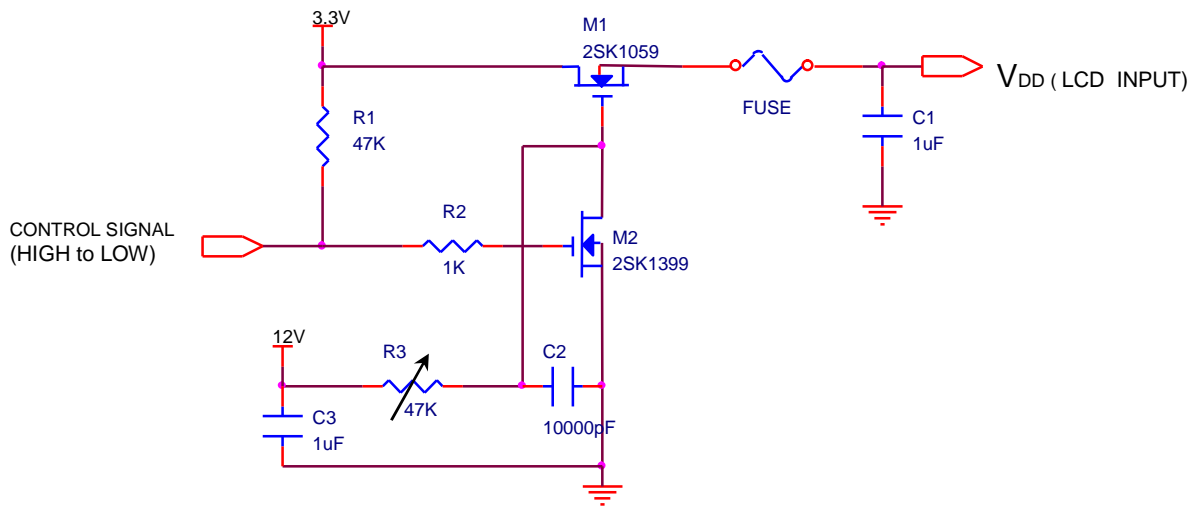

V_{DD} rising time is 470us

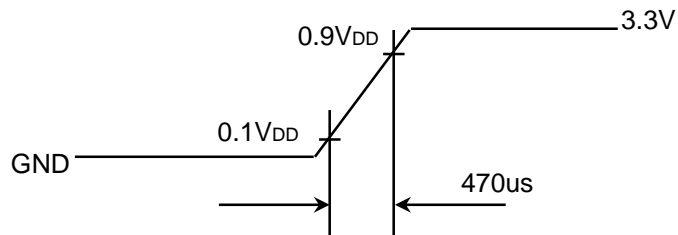

Samsung Secret

3.2 BACK-LIGHT UNIT

Ta= 25 ± 2 °C

Item	Symbol	Min.	Typ.	Max.	Unit	Note
LED Forward Current	IF	-	20	-	mA	
LED Forward Voltage	VF	-	3.2	-	V	
LED Array Voltage	VP	-	22.4	-	V	Vf X 7 LEDs
Power Consumption	P	-	3.2	-	W	If X Vf X 42 LEDs

Samsung Secret

4. BLOCK DIAGRAM

4.1 TFT LCD Module

LTN140AT01-G01 Circuit Block Diagram

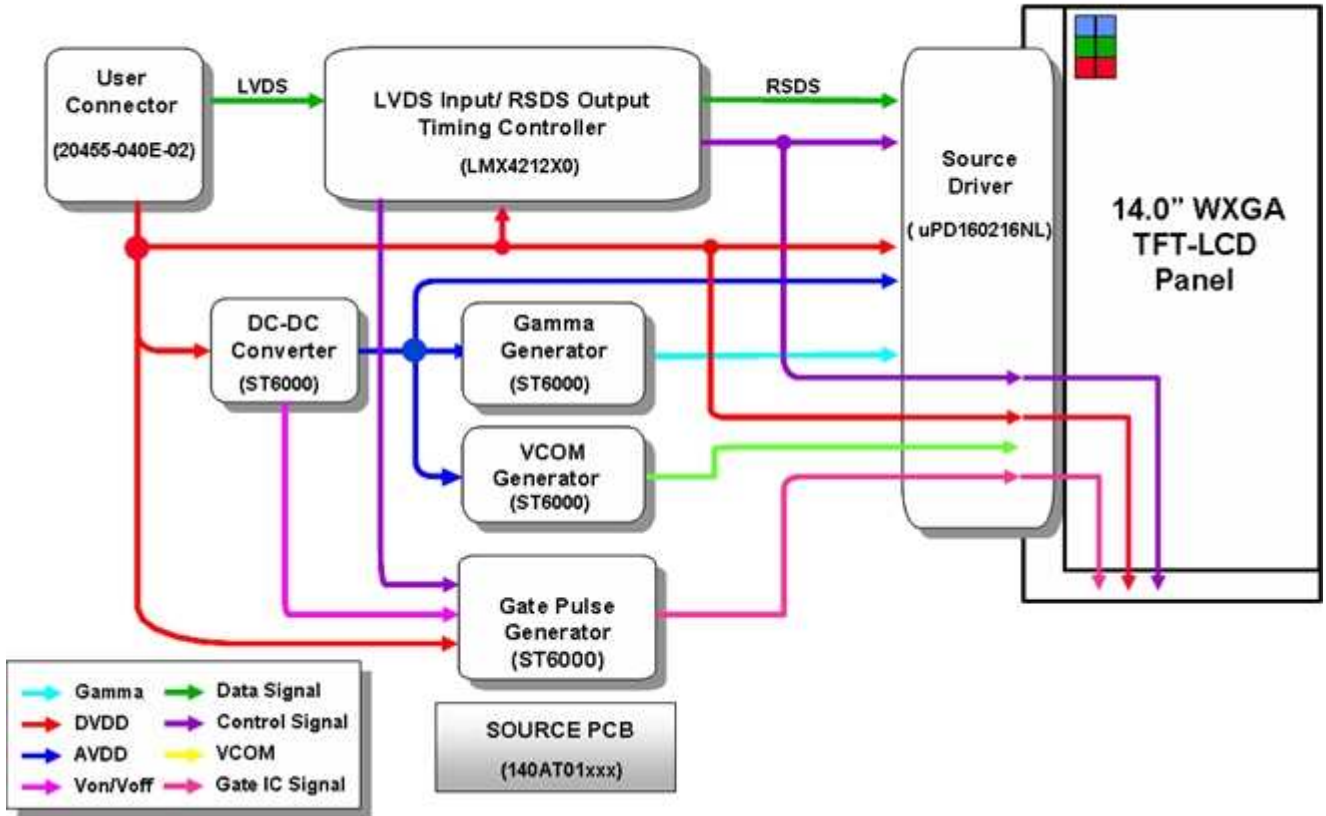

4.2 LED placement structure

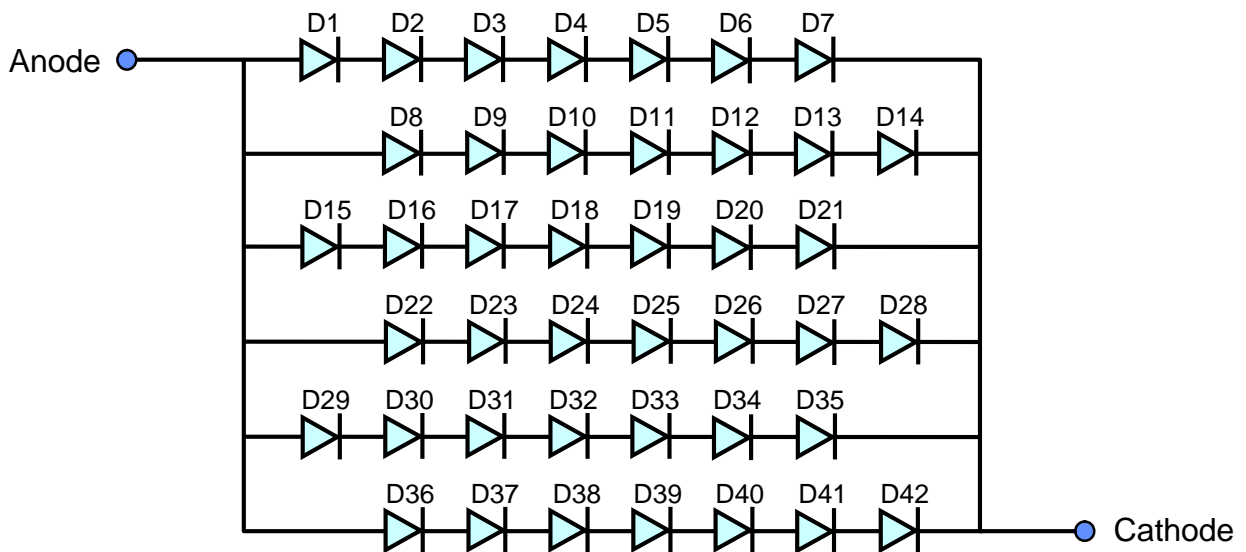

Samsung Secret

5. INPUT TERMINAL PIN ASSIGNMENT

5.1. Input Signal & Power (Input connector : I-PEX's 20455-40E or Compatible LVDS Receiver : DS90CF364 or Compatible)

Pin	Symbol	Function
1	NC	no connect
2~3	VDD	Logic power 3.3V (Panel logic, BL logic)
4	VEDID	EDID 3.3V power
5	NC	no connect
6	CLK	EDID clock
7	DATA	EDID data
8	RIN0-	- LVDS differential data input (R0-R5, G0)
9	RIN0+	+ LVDS differential data input (R0-R5, G0)
10	GND	Ground
11	RIN1-	- LVDS differential data input (G1-G5, B0-B1)
12	RIN1+	+ LVDS differential data input (G1-G5, B0-B1)
13	GND	Ground
14	RIN2-	- LVDS differential data input (B2-B5,HS,VS, DE)
15	RIN2+	+ LVDS differential data input (B2-B5,HS,VS, DE)
16	GND	Ground
17	CLK-	- LVDS differential clock input
18	CLK+	+ LVDS differential clock input
19	GND	Ground
20 ~ 21	NC	no connect
22	GND	Ground
23 ~ 24	NC	no connect
25	GND	Ground
26 ~ 27	NC	no connect
28	GND	Ground
29 ~ 30	NC	no connect
31 ~ 33	VLED_GND	LED Ground
34	NC	no connect
35	S_PWMIN	System PWM Signal Input
36	BL_ON	LED enable pin (+3V input, +5V tolerance)
37	NC	no connect
38~40	VLED	LED Power Supply 7V-20V

Samsung Secret

5.2 LVDS Transmitter : DS90C363 or Compatible

< LVDS for Odd pixel >

Pin No.	Name	RGB Signal	Pin No.	Name	RGB Signal
44	TxIN0	R0	12	TxIN11	G5
45	TxIN1	R1	13	TxIN12	B0
47	TxIN2	R2	15	TxIN13	B1
48	TxIN3	R3	16	TxIN14	B2
1	TxIN4	R4	18	TxIN15	B3
3	TxIN5	R5	19	TxIN16	B4
4	TxIN6	G0	20	TxIN17	B5
6	TxIN7	G1	22	TxIN18	Hsync
7	TxIN8	G2	23	TxIN19	Vsync
9	TxIN9	G3	25	TxIN20	DE
10	TxIN10	G4	26	TxCLKIN	Clock

< LVDS for Even pixel >

Pin No.	Name	RGB Signal	Pin No.	Name	RGB Signal
44	TxIN0	RE0	12	TxIN11	GE5
45	TxIN1	RE1	13	TxIN12	BE0
47	TxIN2	RE2	15	TxIN13	BE1
48	TxIN3	RE3	16	TxIN14	BE2
1	TxIN4	RE4	18	TxIN15	BE3
3	TxIN5	RE5	19	TxIN16	BE4
4	TxIN6	GE0	20	TxIN17	BE5
6	TxIN7	GE1	22	TxIN18	Hsync
7	TxIN8	GE2	23	TxIN19	Vsync
9	TxIN9	GE3	25	TxIN20	DE
10	TxIN10	GE4	26	TxCLK IN	Clock

Samsung Secret

LVDS INTERFACE

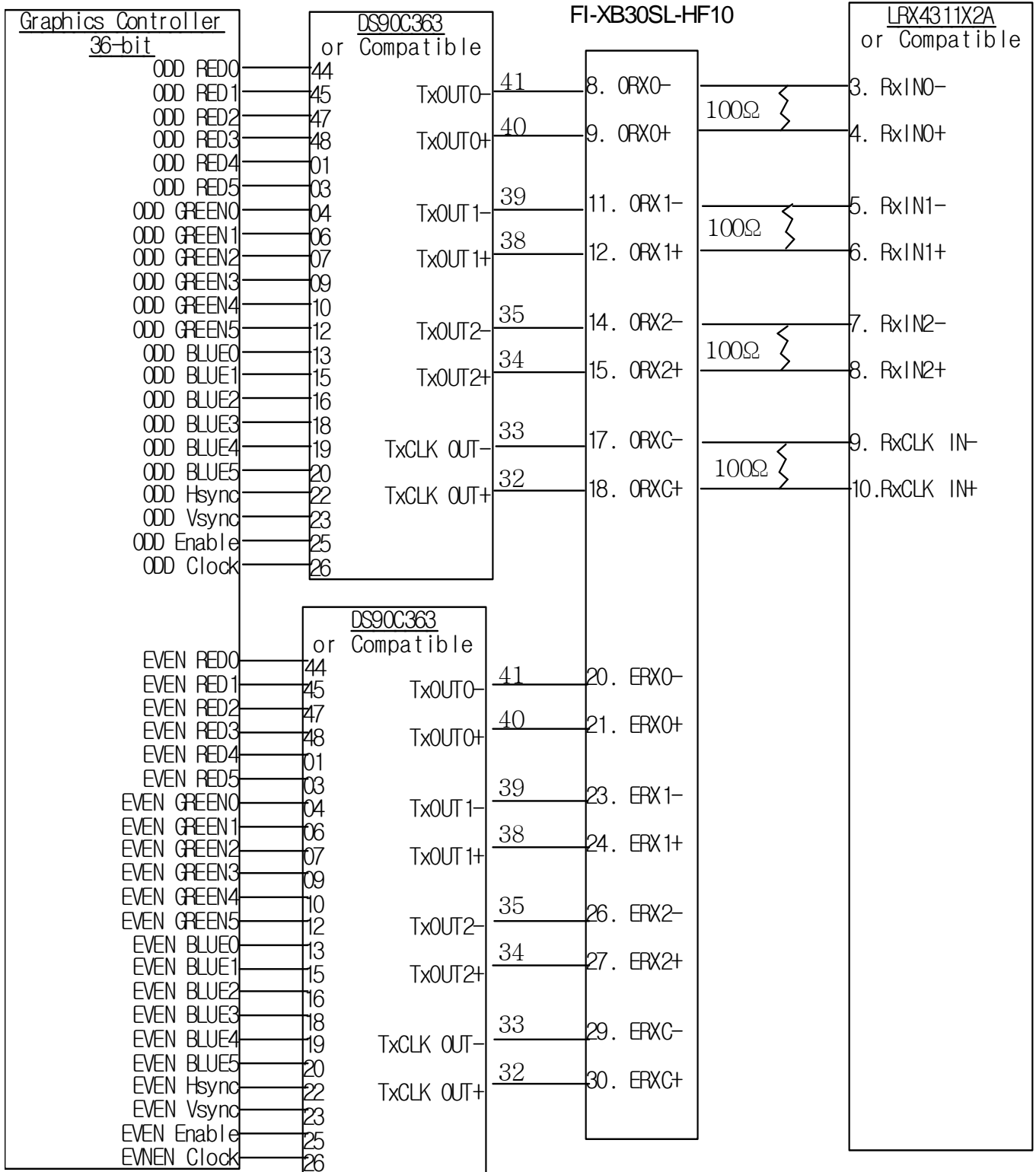

Samsung Secret

5.3 Timing Diagrams of LVDS For Transmission

LVDS Receiver : Integrated T-CON

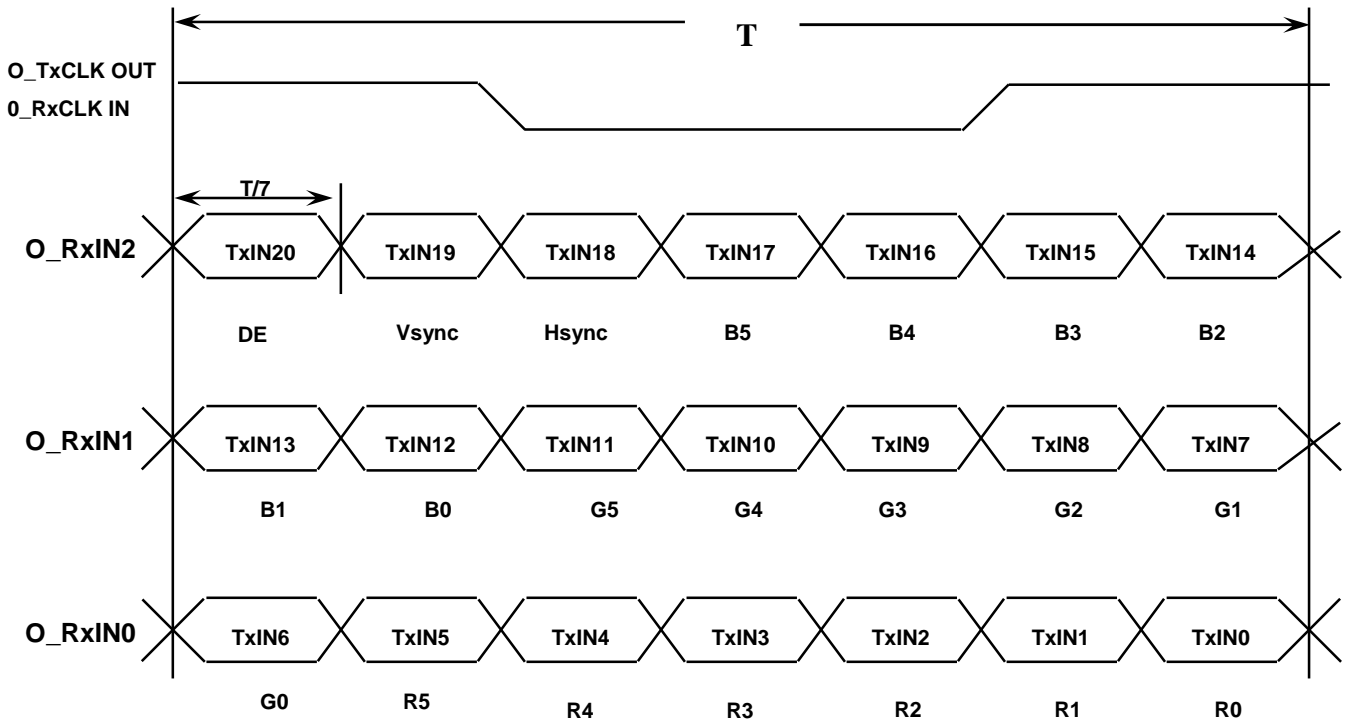

Samsung Secret

5.4 Input Signals, Basic Display Colors and Gray Scale of Each Color

Color	Display	Data Signal																Gray Scale Level	
		Red					Green					Blue							
		R0	R1	R2	R3	R4	R5	G0	G1	G2	G3	G4	G5	B0	B1	B2	B3		45
Basic Colors	Black	0	0	0	0	0	0	0	0	0	0	0	0	0	0	0	0	0	-
	Blue	0	0	0	0	0	0	0	0	0	0	0	0	1	1	1	1	1	-
	Green	0	0	0	0	0	0	1	1	1	1	1	1	0	0	0	0	0	-
	Cyan	0	0	0	0	0	0	1	1	1	1	1	1	1	1	1	1	1	-
	Red	1	1	1	1	1	1	0	0	0	0	0	0	0	0	0	0	0	-
	Magenta	1	1	1	1	1	1	0	0	0	0	0	0	1	1	1	1	1	-
	Yellow	1	1	1	1	1	1	1	1	1	1	1	1	0	0	0	0	0	-
	White	1	1	1	1	1	1	1	1	1	1	1	1	1	1	1	1	1	-
Gray Scale Of Red	Black	0	0	0	0	0	0	0	0	0	0	0	0	0	0	0	0	0	R0
	Dark	1	0	0	0	0	0	0	0	0	0	0	0	0	0	0	0	0	R1
	↑	0	1	0	0	0	0	0	0	0	0	0	0	0	0	0	0	0	R3~R60
	:	:	:	:	:	:	:	:	:	:	:	:	:	:	:	:	:	:	
	:	:	:	:	:	:	:	:	:	:	:	:	:	:	:	:	:	:	
	↓	1	0	1	1	1	1	0	0	0	0	0	0	0	0	0	0	0	R61
	Light	0	1	1	1	1	1	0	0	0	0	0	0	0	0	0	0	0	R62
	Red	1	1	1	1	1	1	0	0	0	0	0	0	0	0	0	0	0	R63
Gray Scale Of Green	Black	0	0	0	0	0	0	0	0	0	0	0	0	0	0	0	0	0	G0
	Dark	0	0	0	0	0	0	1	0	0	0	0	0	0	0	0	0	0	G1
	↑	0	0	0	0	0	0	0	1	0	0	0	0	0	0	0	0	0	G3~G60
	:	:	:	:	:	:	:	:	:	:	:	:	:	:	:	:	:	:	
	:	:	:	:	:	:	:	:	:	:	:	:	:	:	:	:	:	:	
	↓	0	0	0	0	0	0	1	0	1	1	1	1	0	0	0	0	0	G61
	Light	0	0	0	0	0	0	0	1	1	1	1	1	0	0	0	0	0	G62
	Green	0	0	0	0	0	0	1	1	1	1	1	1	0	0	0	0	0	G63
Gray Scale Of Blue	Black	0	0	0	0	0	0	0	0	0	0	0	0	0	0	0	0	0	B0
	Dark	0	0	0	0	0	0	0	0	0	0	0	0	1	0	0	0	0	B1
	↑	0	0	0	0	0	0	0	0	0	0	0	0	0	1	0	0	0	B2
	:	:	:	:	:	:	:	:	:	:	:	:	:	:	:	:	:	:	B3~B60
	:	:	:	:	:	:	:	:	:	:	:	:	:	:	:	:	:	:	
	↓	0	0	0	0	0	0	0	0	0	0	0	0	1	0	1	1	1	
	Light	0	0	0	0	0	0	0	0	0	0	0	0	0	1	1	1	1	B62
	Blue	0	0	0	0	0	0	0	0	0	0	0	0	1	1	1	1	1	B63

Note 1) Definition of gray :

Rn: Red gray, Gn: Green gray, Bn: Blue gray (n=gray level)

Note 2) Input signal: 0 =Low level voltage, 1=High level voltage

Samsung Secret

5.5 Pixel Format in the display

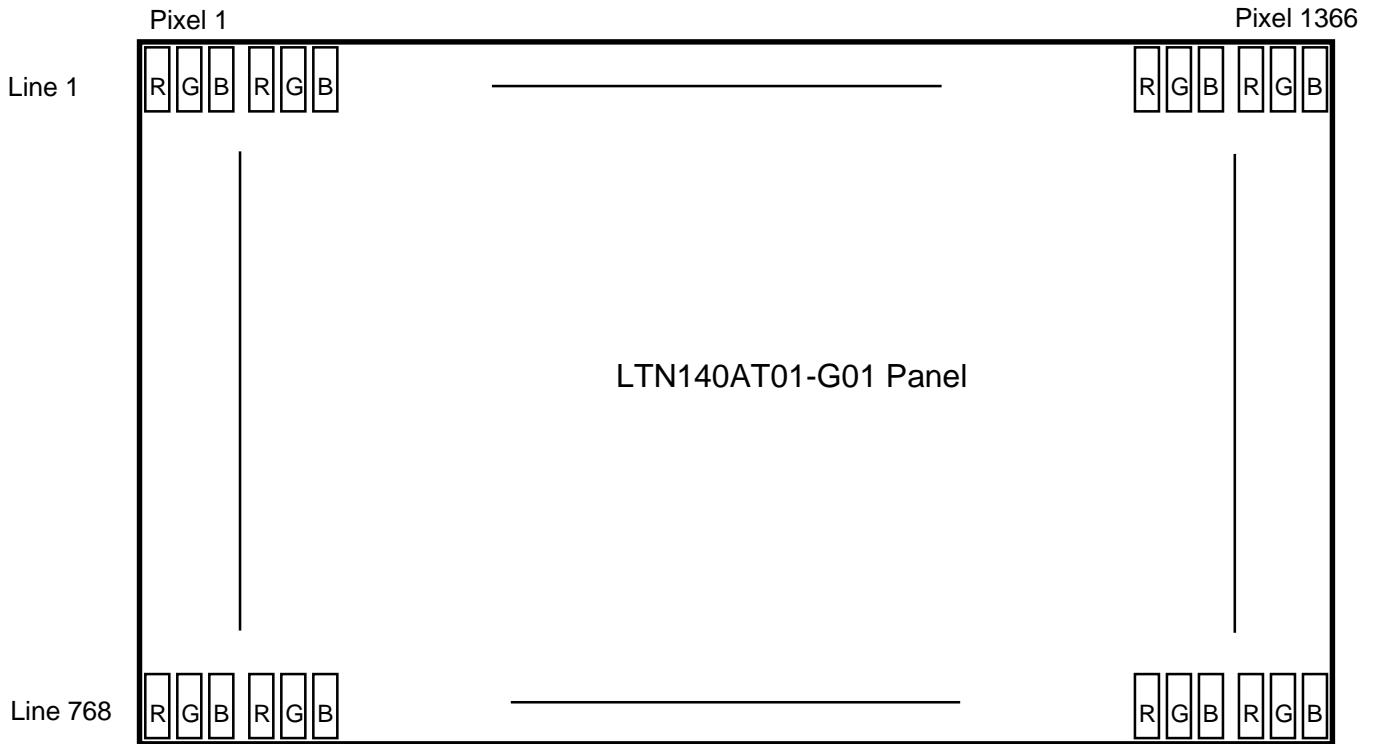

Samsung Secret

6. INTERFACE TIMING

6.1 Timing Parameters

Signal	Item	Symbol	Min.	Typ.	Max.	Unit	Note
Frame Frequency	Cycle	TV	780	790	980	Lines	-
Vertical Active Display Term	Display Period	TVD	-	768	-	Lines	-
One Line Scanning Time	Cycle	TH	1440	1526	1800	Clocks	-
Horizontal Active Display Term	Display Period	THD	-	1366	-	Clocks	-

6.2 Timing diagrams of interface signal

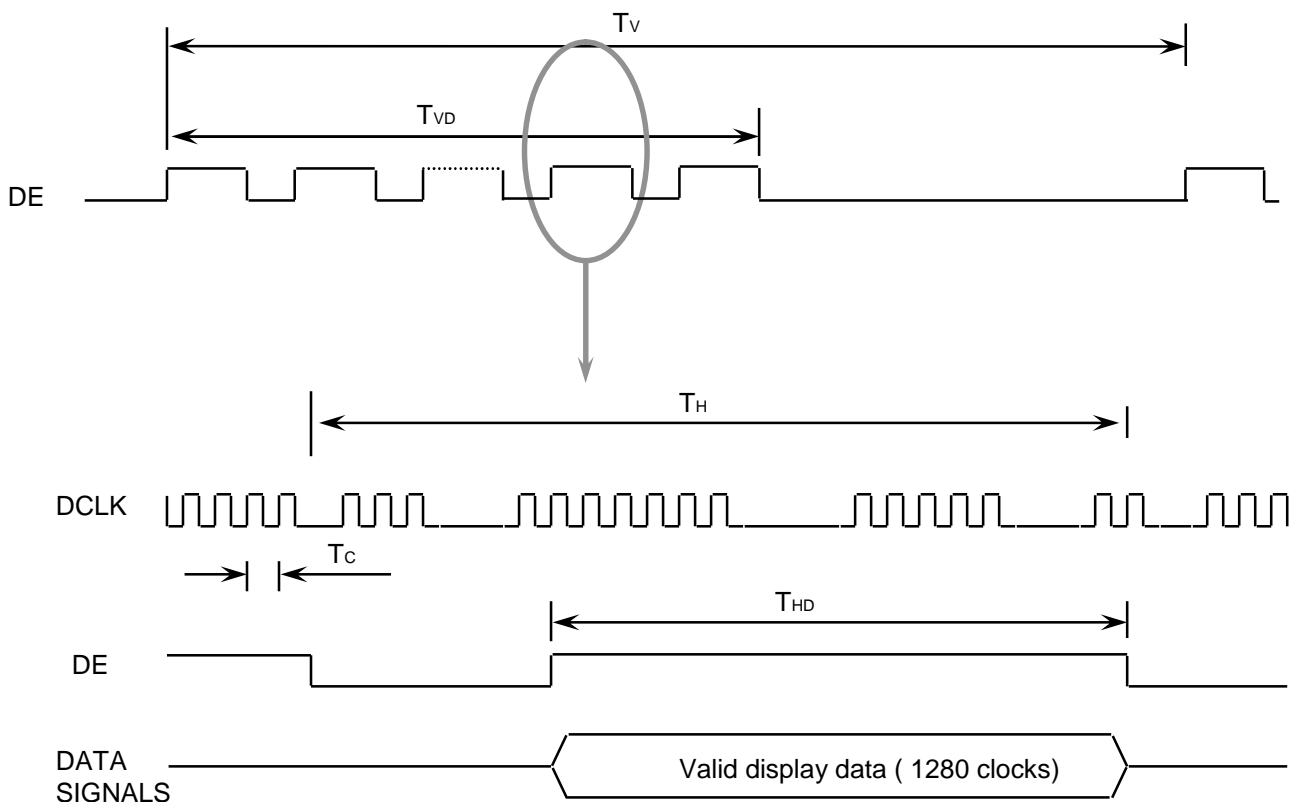

Samsung Secret

6.3 Power ON/OFF Sequence

Preliminary

: To prevent a latch-up or DC operation of the LCD module, the power on/off sequence should be as the diagram below.

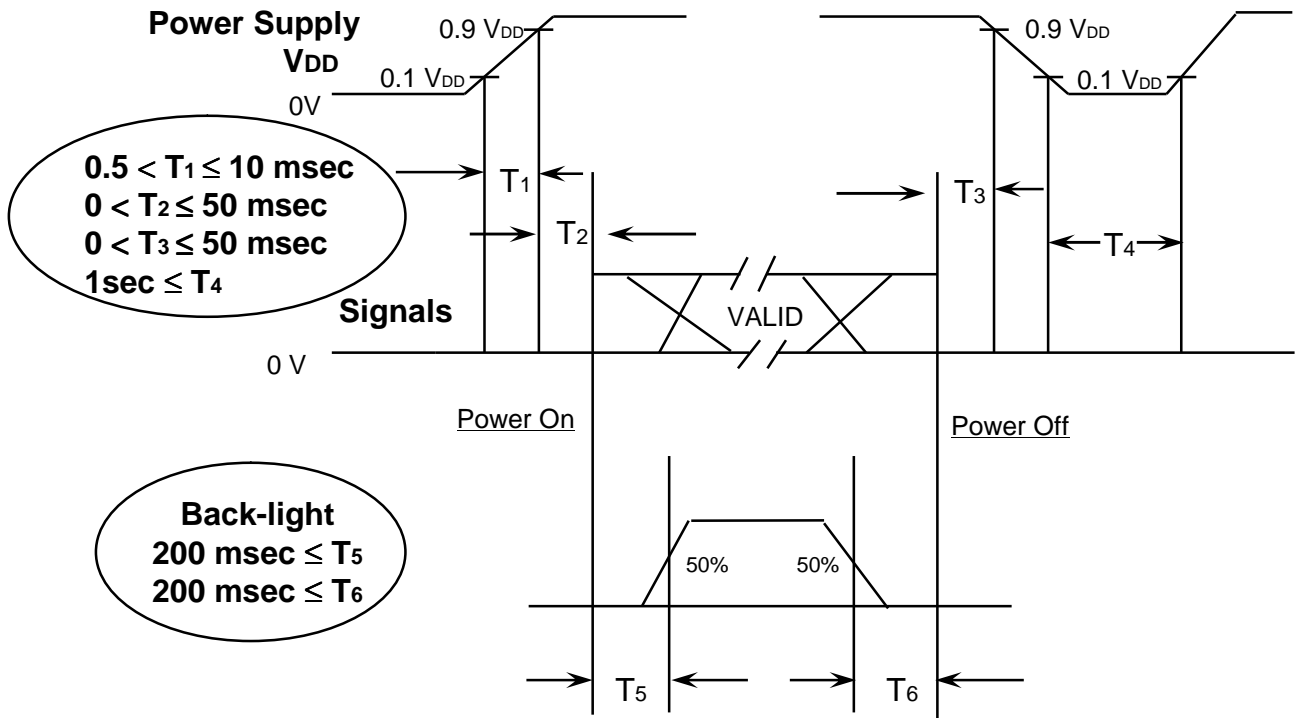

Power ON/OFF Sequence

- T1 : V_{DD} rising time from 10% to 90%
- T2 : The time from V_{DD} to valid data at power ON.
- T3 : The time from valid data off to V_{DD} off at power Off.
- T4 : V_{DD} off time for Windows restart
- T5 : The time from valid data to B/L enable at power ON.
- T6 : The time from valid data off to B/L disable at power Off.

NOTE.

- (1) The supply voltage of the external system for the module input should be the same as the definition of V_{DD}.
- (2) Apply the lamp voltage within the LCD operation range. When the back-light turns on before the LCD operation or the LCD turns off before the back-light turns off, the display may momentarily become white.
- (3) In case of V_{DD} = off level, please keep the level of input signals on the low or keep a high impedance.
- (4) T4 should be measured after the module has been fully discharged between power off and on period.
- (5) Interface signal shall not be kept at high impedance when the power is on.

Samsung Secret

7. MECHANICAL OUTLINE DIMENSION

Preliminary

[Refer to the next page]

Samsung Secret

Doc.No.	LTN140AT01-G01	Rev.No	04-P05-G-081007	Page	21 / 30
----------------	----------------	---------------	-----------------	-------------	---------

NO	PART NAME	CODE NO	SPECIFICATION	Q'TY	WEIGHT		REMARK
					FINISH	INFLUENCE OF MATERIAL	

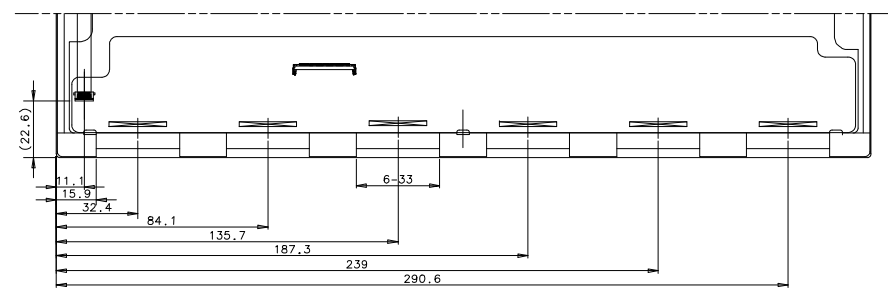
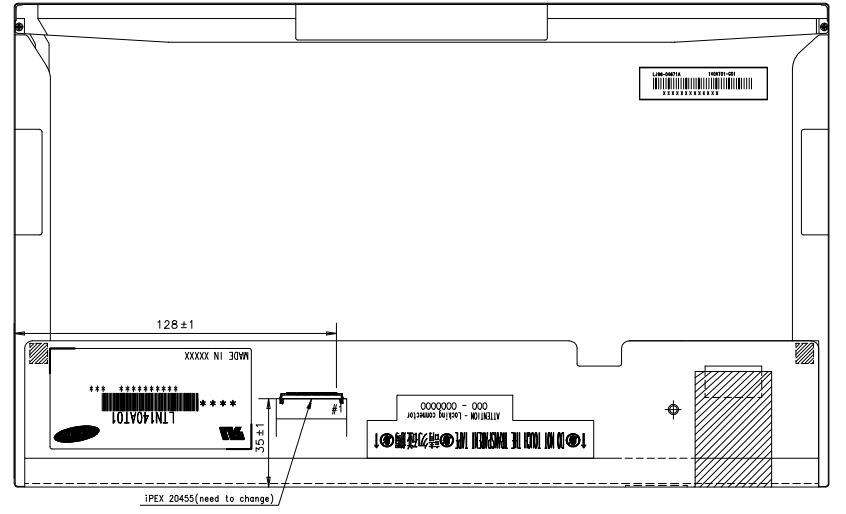
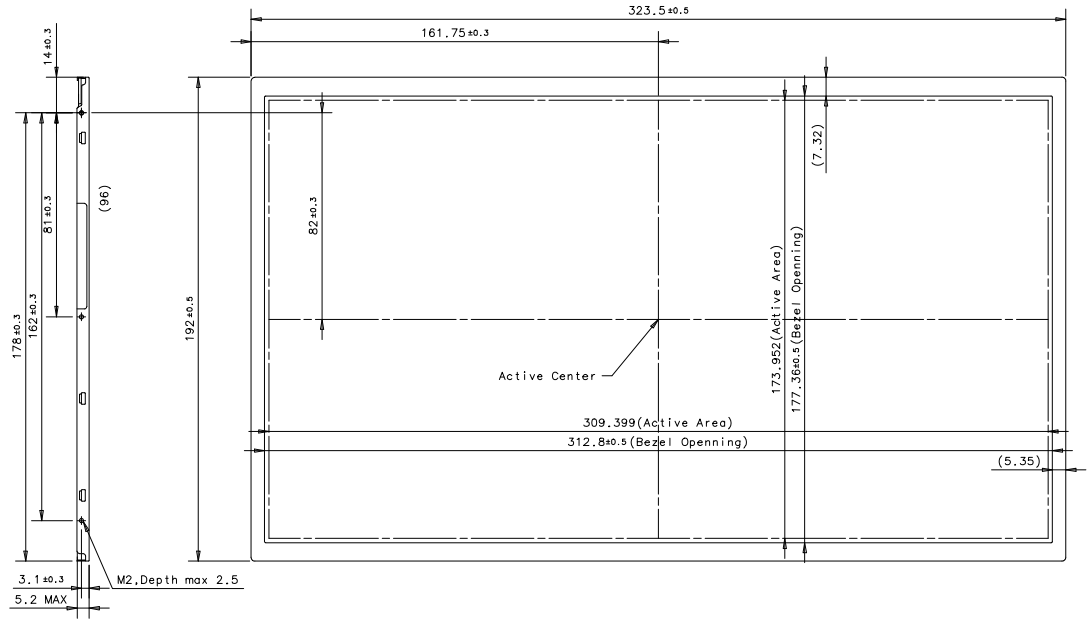

- * NOTE
1. ALLOWED DEPTH OF USERHOLE SCREW INSERTION IS 2.5mm MAX.
 2. MAXIMUM SCREW TORQUE SPEC : 2.5kgf-cm Max
 3. MODULE WEIGHT SPEC : 350g MAX
 4. MEASURING FORCE : 750 +/- 250gf-cm

NO. 010-11-V-1R

REV	DATE	DESCRIPTION OF REVISION	REASON	CHK'D BY

UNIT	mm	DRA'N BY	DES'D BY	CHK'D BY	APP'D BY	MODEL NAME	LTM140A01	
SCALE	1/1	H.S.DHR				PART/SHEET NAME	OUTLINE DIMENSION	
TOLERANCE	±0.3	08.06.17				SPEC. NO		
SAMSUNG ELECTRONICS							CODE NO.	
							SHEET	1/1
							VER.	000

8. PACKING

1. CARTON(Internal Package)

(1) Packing Form

Corrugated Cardboard box and Corrupad form as shock absorber

(2) Packing Method

Packing Case



Cushion (Bottom)



Cushion (Top)



Note (1) Total : Approx. 15 Kg

(2) Acceptance number of piling : 10sets

(3) Carton size : 408(W) X 325(D) X 294(H)

Samsung Secret

(3)Packing Material

No	Part name	Quantity
1	Static electric protective sack	10
2	Packing case (Inner box) included shock absorber	1 set
3	Pictorial marking	2 pcs
4	Carton	1 set

9. MARKINGS & OTHERS

A nameplate bearing followed by is affixed to a shipped product at the specified location on each product.

- (1)Parts number : LTN140AT01-G01
- (2)Revision code : 1 letter
- (3)Control code ; 1 letter
- (3)Lot number : 6 D 5 K XXX XX X

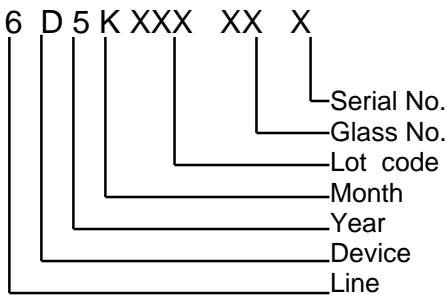

(5) Nameplate Indication

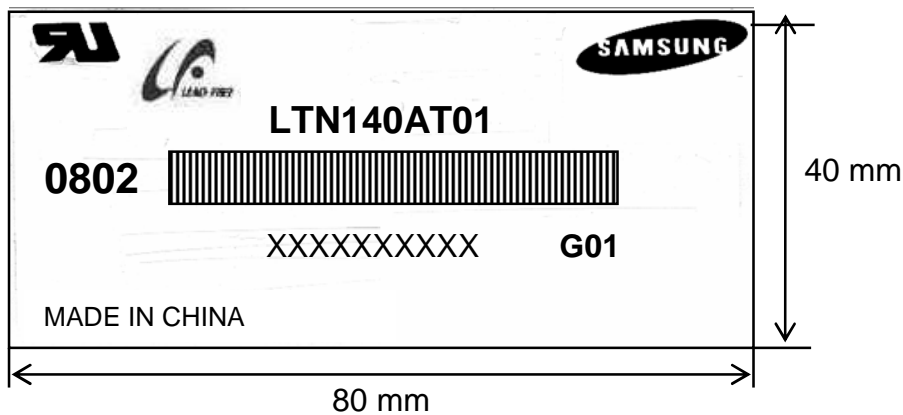

Parts name : LTN140AT01
 Lot number : XXXXXXXXXX
 Inspected work week : 0802(2008 year, 2nd week)

Samsung Secret

High voltage caution label

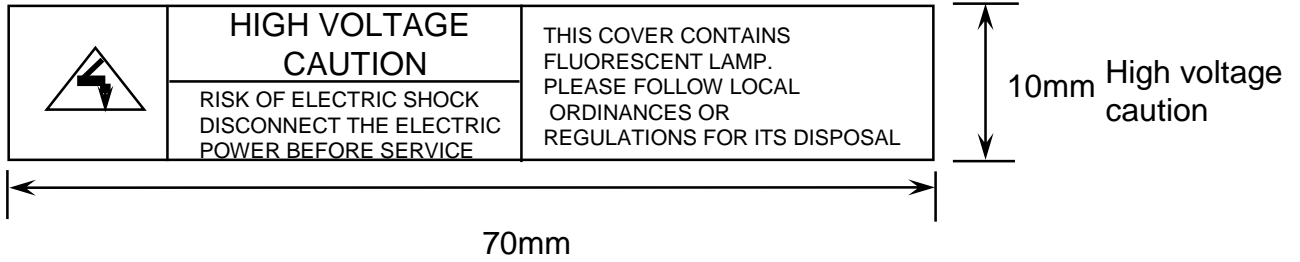

(6) Packing small box attach

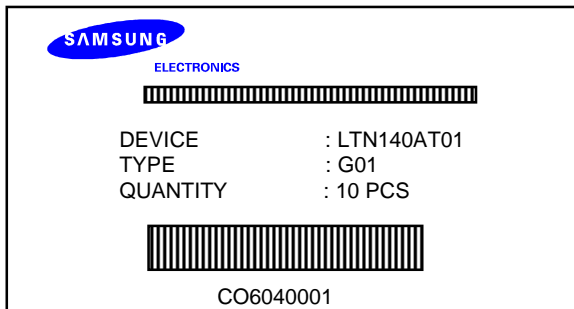

(7) Packing box Marking : Samsung TFT-LCD Brand Name



Samsung Secret

10. GENERAL PRECAUTIONS

Preliminary

1. Handling

- (a) When the module is assembled, It should be attached to the system firmly using every mounting holes. Be careful not to twist and bend the modules.
- (b) Refrain from strong mechanical shock and / or any force to the module. In addition to damage, this may cause improper operation or damage to the module and CCFT back-light.
- (c) Note that polarizers are very fragile and could be easily damaged. Do not press or scratch the surface harder than a HB pencil lead.
- (d) Wipe off water droplets or oil immediately. If you leave the droplets for a long time, Staining and discoloration may occur.
- (e) If the surface of the polarizer is dirty, clean it using some absorbent cotton or soft cloth.
- (f) The desirable cleaners are water, IPA (Isopropyl Alcohol) or Hexane. Do not use Ketone type materials(ex. Acetone), Ethyl alcohol, Toluene, Ethyl acid or Methyl chloride. It might permanent damage to the polarizer due to chemical reaction.
- (g) If the liquid crystal material leaks from the panel, it should be kept away from the eyes or mouth. In case of contact with hands, legs or clothes, it must be washed away thoroughly with soap.
- (h) Protect the module from static, it may cause damage to the C-MOS Gate Array IC.
- (i) Use fingerstalls with soft gloves in order to keep display clean during the incoming inspection and assembly process.
- (j) Do not disassemble the module.
- (k) Do not pull or fold the lamp wire.
- (l) Do not adjust the variable resistor which is located on the back side.
- (m) Protection film for polarizer on the module shall be slowly peeled off just before use so that the electrostatic charge can be minimized.
- (n) Pins of I/F connector shall not be touched directly with bare hands.

Samsung Secret

Doc.No.	LTN140AT01-G01	Rev.No	04-P05-G-081007	Page	26 / 30
----------------	----------------	---------------	-----------------	-------------	---------

2. STORAGE

- (a) Do not leave the module in high temperature, and high humidity for a long time.
It is highly recommended to store the module with temperature from 0 to 35 °C and relative humidity of less than 70%.
- (b) Do not store the TFT-LCD module in direct sunlight.
- (c) The module shall be stored in a dark place. It is prohibited to apply sunlight or fluorescent light during the store.

3. OPERATION

- (a) Do not connect, disconnect the module in the “ Power On” condition.
- (b) Power supply should always be turned on/off by following item 6.3
“ Power on/off sequence “.
- (c) Module has high frequency circuits. Sufficient suppression to the electromagnetic interference shall be done by system manufacturers. Grounding and shielding methods may be important to minimize the interference.
- (d) The cable between the back-light connector and its inverter power supply shall be a minimized length and be connected directly . The longer cable between the back-light and the inverter may cause lower luminance of lamp(CCFT) and may require higher startup voltage (Vs).
- (e) The standard limited warranty is only applicable when the module is used for general notebook applications. If used for purposes other than as specified, SEC is not to be held reliable for the defective operations. It is strongly recommended to contact SEC to find out fitness for a particular purpose.

4. OTHERS

- (a) Ultra-violet ray filter is necessary for outdoor operation.
- (b) Avoid condensation of water. It may result in improper operation or disconnection of electrode.
- (c) Do not exceed the absolute maximum rating value. (the supply voltage variation, input voltage variation, variation in part contents and environmental temperature, so on)
Otherwise the module may be damaged.
- (d) If the module displays the same pattern continuously for a long period of time, it can be the situation when the image “sticks” to the screen.
- (e) This module has its circuitry PCB's on the rear side and should be handled carefully in order not to be stressed.

Samsung Secret

Doc.No.	LTN140AT01-G01	Rev.No	04-P05-G-081007	Page	27 / 30
----------------	----------------	---------------	-----------------	-------------	---------